

TESA-HITE: THE NEW GENERATION

YOUR BEST METROLOGY EXPERIENCE, BEYOND ACCURACY AND ROBUSTNESS



INSTALL THE MEASUREMENT AS CLOSE AS POSSIBLE TO THE USER

The height gauges of the TESA-HITE range are specially designed for workshop measurements, where ensuring quality metrology is generally complicated. These instruments are often subject to harsh environmental factors (temperature, projections, etc.). Under these circumstances it is an essential challenge to make the measurement reliable in order to maintain and effectively increase the productivity.



TESA-HITE MAGNA

Its robust magnetic reading system makes it a height gauge for measurements in particularly difficult conditions.

Available sizes

400 mm - 700 mm

Onboard (patented) technologies



magna system



TESA-HITE

Optical reading system for users looking for greater accuracy than its magnetic system counterpart without having to compromise on its long-term reliability.

Available sizes

400 mm - 700 mm

Onboard (patented) technologies



opto system

THE SECURITY OF A PRODUCT OF QUALITY

Since their development phase, TESA products are subject to strict internal standards aligned with the most restrictive national standards. Thanks to this close monitoring, all TESA height gauges meet the quality requirements that we strive to keep as sharp as possible.



SCS certificate

Each gauge of the range is delivered with a SCS (Swiss Calibration Service) certificate of measurement.

Any hidden additional extra cost due to a re-certification of the instrument after purchase is avoided.

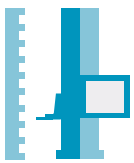

Calibration process

All the height gauges of the TESA range are calibrated and inspected in accordance with the standards described by the ISO 13225 standard. Each instrument is controlled and calibrated according to processes comparable to a real daily use.

The announced technical specifications are in agreement with a real use of the instrument.



A philosophy of use for everyone

4 interface themes to choose from, ergonomic control panel, context based help etc... the TESA-HITE range has been developed to be more easily accessible by any user profile and to make its current use pleasant.

*1. Short learning time required
2. Autonomy of use achieved in maximum 2 hours
3. A theme using the interface of the previous models for a "smooth" transition to the more recent models*



Clear information

No confusion! At any time, the displayed values correspond solely to a measurement or calculation and not to the instantaneous position of the probe.

Decrease of possible errors due to bad interpretations of the displayed results.



A robust construction

In addition to their spheroidal cast iron base, the models incorporate widely proven materials used in the manufacture of traditional industrial parts.

The components' stability provides reliability of the instrument in the long term.

TESA Reading system
(patented)
magnaDsystem

Probe support and
probe

Spheroidal
cast-iron base

Contact and support
surfaces

TESA-HITE MAGNA

Carriage locking screw

Fine adjustment
screw

Handwheel for manual
displacement

Backlit colour
screen

Refined
keyboard

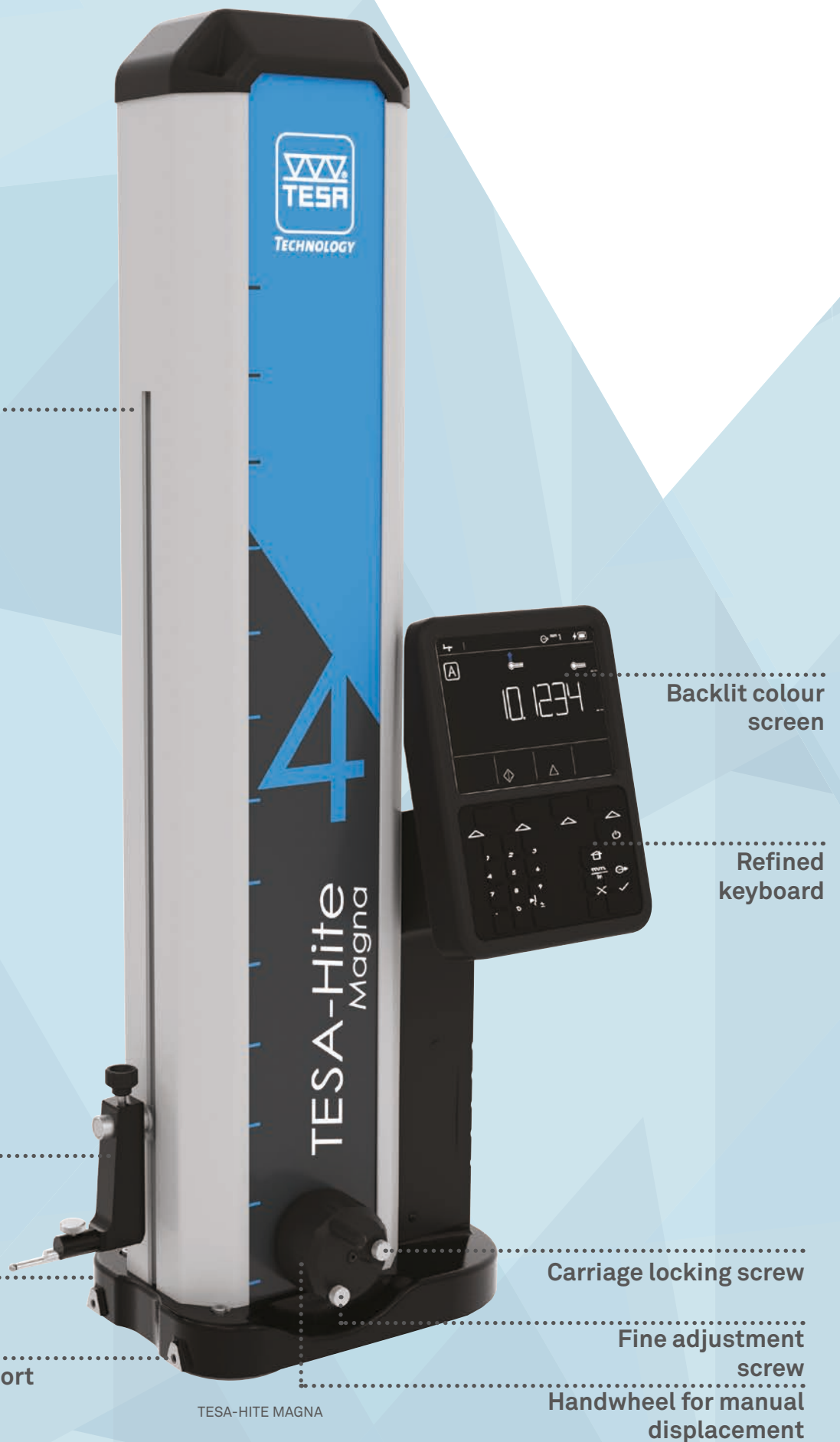



TESA Reading system
(patented)
opto μ system

Backlit colour
screen

Refined
keyboard

Probe support and
probe

Activation of the
air cushion

Spheroidal
cast-iron base

Carriage locking screw

Contact and support
surfaces

Fine adjustment
screw

Handwheel for manual
displacement

TESA-HITE



Intelligent software

Derived from the proven QUICKCENTER technology integrated in the MICRO-HITE range models, the QUICKCENTER DYNAMIC embedded intelligence is a valuable aid and simplifies the process when measuring culmination points (minimum, maximum) or diameters.

The instrument automatically detects which type of culmination point is being measured and returns the information to the screen without any user intervention except for the measurement itself.



Simplified culmination point measurement process, that drastically reduces the time required for bore/axis measurement.

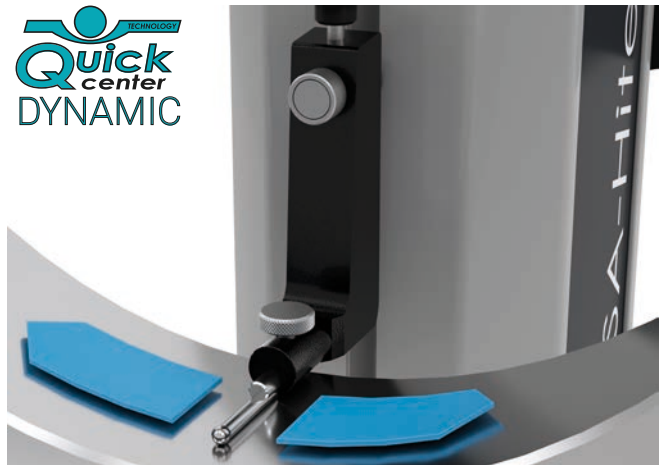

A refined and intuitive keyboard

With a refined panel, with a number of keys reduced to the bare minimum, the handling is easy, fast and leaves no room for confusion.



1 key = 1 function

It is no longer necessary to spend long hours learning the instrument.

The understanding of the instrument is intuitive, which avoids hidden handling costs during the setting-in.



Comfortable handling

You are you going to use the height gauge frequently?
No problem!

Comfort is definitely an important criterion when using the instrument regularly and the TESA-HITE has been specially developed for this purpose.



Convenient wrist posture when displacing the height gauge on its working table.



IP65 Stands up to the challenge

The height gauges of the TESA-HITE range are generally multi-user instruments subject to regular use in demanding environments. In this context, the control panel acts as a link between the instrument and the user. Due to its intensive use it is a sensitive element of the system that must resist over time.

👍 *The high resistance of the control panel, necessary to guarantee its longevity, is essentially due to a choice of high quality components that allow a serene use, even in environments subject to excesses of all kinds (oil, water etc.).*

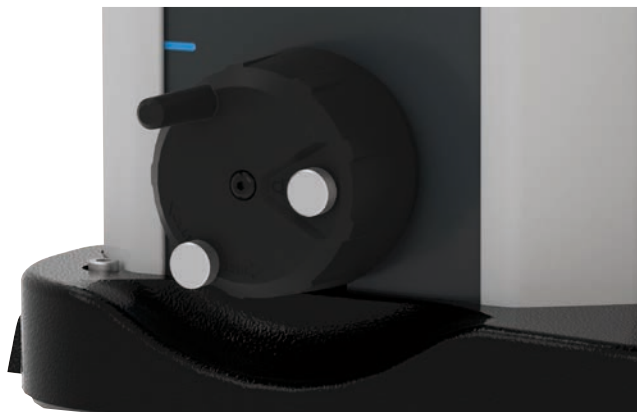

Adjusted to meet your real needs

The handwheel for displacement of the measuring carriage also includes a fine adjustment system.

👍 *The fine adjustment is often necessary in order to accurately position the probe in small elements. In some cases, it is also necessary to block the carriage to ensure a constant measuring force on the surface to be measured.*

TESA patented magnetic system

The embedded magnetic system of the TESA-HITE MAGNA models is not sensitive to dirt that could penetrate the instrument. While most integrated optical systems require a higher level of cleanliness, the TESA system is generally much more stable. Indeed, it is in no way hindered by dust or water particles commonly present in closed environments such as machine shops.

👍 *For any operating environment that is known as complicated, the patented MAGNA μ SYSTEM system gives a real advantage to the TESA-HITE MAGNA height gauges. Their more robust reading system makes them flexible and reliable over time.*





Clear interface

A good reading of the display, clear and unambiguous information are important elements when using an instrument frequently. Therefore, the interface is divided in clearly defined areas that allow the user to concentrate on the essential points of his measurement without having to continuously decrypt the displayed results.

- 1. Learning time reduced to the strict minimum
- 2. User satisfaction
- 3. Minimized transcription error rate
- 4. Better performance

Context-based help

Do you think you'll get lost in the intricacies of the complex user interface?
Well, not at all!
No stress! If any action is required on your part, the software informs you with a blinking icon.



- 1. The user is constantly guided and is never lost during the use of the instrument.
- 2. The context-based help is particularly welcome while learning how to use the gauge.



Everyone has his own interface

The interface can now be customized. An option has been integrated into the software to modify the information displayed on the screen according to the user's wishes.

- 1. Because each user has different wishes, the software allows you to choose between 4 predefined themes in order to display, or hide, certain information.

For user-friendliness, one of the proposed designs is identical to the surface of the previous models.

DATA MANAGEMENT



It is possible to connect the instrument to a computer or any other peripheral unit via the TLC (TESA Link Connector) on the rear of the panel to receive the measuring results on it.

This connection can be achieved by cable or wireless.

The data can be sent automatically after each measurement or on demand by the user.

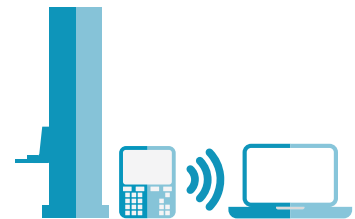
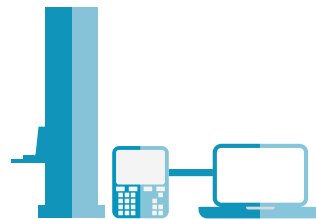

Retrieve data with ease

The height gauges of this range, as well as most of the TESA instruments are compatible with the free TESA DATA-VIEWER software, allowing a quick and easy handling of all measurement data.

The data is then automatically transferred to files in known formats such as *. xls, *. csv, or Q-DAS.

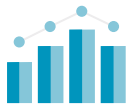

The quick and easy statistical software

The SPC (Statistical Process Control) TESA STAT-EXPRESS software is the way to calculate in real time all the important characteristics during statistical analyses. Quick to learn, it manages also automatically the measuring reports.

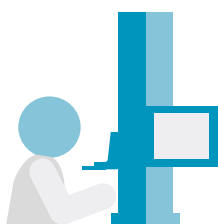

Sending the raw values



Statistical analyses in real time

Automatic creation of measuring reports



For demanding statistics

For users with more extensive needs, Q-DAS software will be able to meet the most specific requirements:

- Control and traceability
- Automated data recovery
- Setting up dashboards
- Quality management
- Optimization of production processes
- Supplier quality monitoring



PROBES 1D
+
PROBE HOLDERS 08 MM
(00760222)
+
TESA TWIN-T10
(04430013)

TLC-BLE
(04760183)
+
DATA-VIEWER



DATA-VIEWER



Q-DAS



STAT-EXPRESS
(04981002)



DESK PRINTER



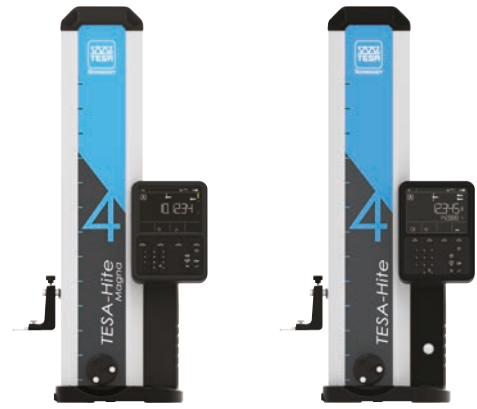

		TESA-HITE MAGNA	TESA-HITE
	Single probing	●	●
	Manual memorizing of the current probe position	●	●
	Culmination	●	●
	Double probing	●	●
	Max, min, delta Parallelism, flatness	●	●
	Display of the current value of the probe position.	●	●
	Perpendicularity measurement (mechanical, with external display)		●
	References	1	1
	Distance	●	●
	Midpoint, average height	●	●
	mm/inch conversion	●	●
	Context-based help	●	●
	Preset	●	●
	Sending data through TLC	●	●
	Manual or automatic data transmission	●	●
	4 interface themes	●	●

CONFIGURATIONS



		TESA-HITE MAGNA		TESA-HITE	
Part number		00730082	00730083	00730084	00730085
GAUGE	Manuel displacement	●	●	●	●
	TESA-HITE MAGNA [mm]	400	700		
	TESA-HITE [mm]			400	700
	Air cushion			●	●
	Fine adjustment	●	●	●	●
	Blocking the double carriage	●	●	●	●
	Control panel IP65	●	●	●	●
ACCESSORIES	Probe support, Ø 6mm	●	●	●	●
	Hard-metal probe, Ø 5 mm	●	●	●	●
	6,35 mm / .25 in masterpiece	●	●		
	12,7 mm / .5 in masterpiece			●	●
	Dust cover			optional	
POWER SUPPLY	Integrated rechargeable battery	●	●	●	●
	Power supply	●	●	●	●
	EUR power cable	●	●	●	●
	US power cable	●	●	●	●
	UK power cable	●	●	●	●
OTHERS	Certificat SCS	●	●	●	●
	1 année de garantie	●	●	●	●
	Contrat de maintenance			upon request	



TESA-HITE MAGNA



Workshop height gauge



Manual displacements



1D measurement mode



With fine adjustment system



Backlit colour screen



Magnetic reading system





Included SCS certificate

	TESA-HITE MAGNA 400	TESA-HITE MAGNA 700
Application range [mm]	415	715
Max. perm. errors [μm]	≤ 8	≤ 8
Repeatability (2σ) [μm]	on surface: ≤ 3 on arc: ≤ 5	on surface: ≤ 3 on arc: ≤ 5
Autonomy [h]	60	60
Probing force [N]	$1,5 \pm 0,5$	$1,5 \pm 0,5$
Screen [L x H, mm]	92 x 121	92 x 121
Digit size [L x H, mm]	10 x 21	10 x 21
Resolution [mm]	0,01 / 0,005 / 0,001	0,01 / 0,005 / 0,001
Degree of protection	Measuring system: IP55 Panel: IP65	Measuring system: IP55 Panel: IP65
Weight [kg]	15	18



TESA-HITE

-  Workshop height gauge
-  Manual displacements
-  1D measurement mode
-  With fine adjustment system
-  Backlit colour screen
-  Optical reading system
-  Included SCS certificate
-  Air cushion system

	TESA-HITE 400	TESA-HITE 700
Application range [mm]	415	715
Max. perm. errors [μm], [L en mm]	2,5+4L/1000	2,5+4L/1000
Repeatability (2σ) [μm]	on surface: ≤ 2 on arc: ≤ 3	on surface: ≤ 2 on arc: ≤ 3
Max. mechanical frontal perpendicularity error [μm]	9	13
Autonomy [h]	60	60
Probing force [N]	1,5 \pm 0,5	1,5 \pm 0,5
Screen [L x H, mm]	92 x 121	92 x 121
Digit size [mm]	10 x 21	10 x 21
Resolution [mm]	0,01 / 0,001 / 0,0001	0,01 / 0,001 / 0,0001
Degree of protection	Panel: IP65	Panel: IP65
Weight [kg]	24	30

ACCESSORIES

Probe holders

∅ 6 mm standard probe holder	00760243	-
∅ 6 mm probe holder	00760086	For depth up to 110 mm
∅ 6 mm probe holder	00760087	For depth up to 185 mm
∅ 6 mm probe holder	00760057	Extend the scope of the application
∅ 6 mm probe holder	S07001622	Extend the scope of the application
∅ 8 mm probe holder	00760223	-
Adapter for M3 probe and shaft	00760177	-
Adapter for M1,4 and M2,5 probes	00760096	3 x M1,4 + 2 x M2,5

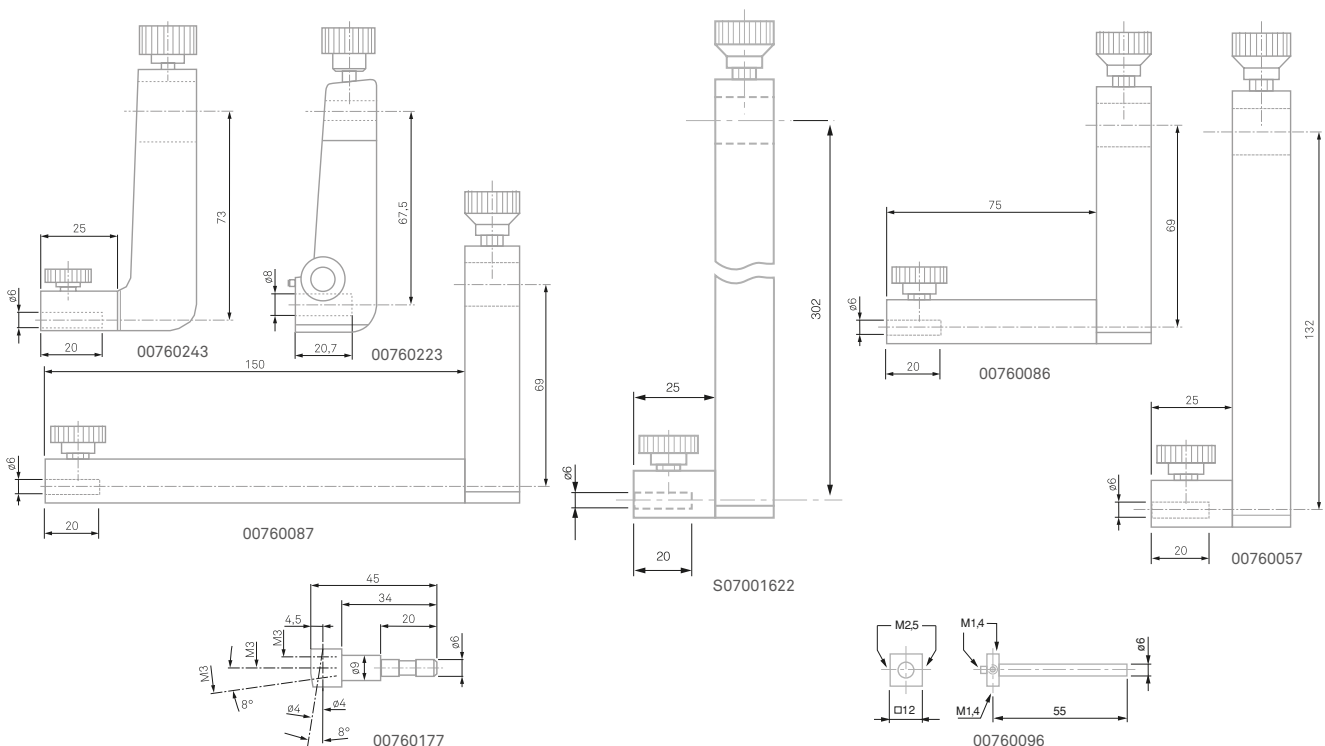
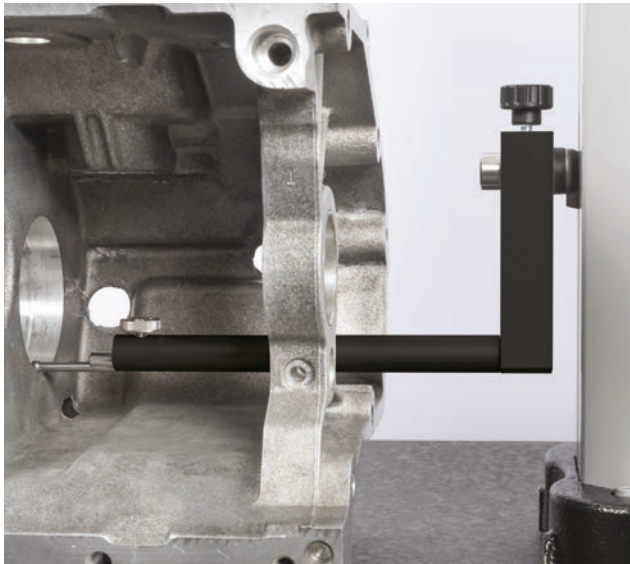

Ball probes

The ball probes are the easiest and most often used in combination with the height gauges which are furthermore delivered as standard with a probe of this type. Because of its form, these accessories are suitable for the majority of probing applications.

∅ 0,9 mm ball probe	00760180	M3 fixation	Hardened steel ball tip
∅ 1,9 mm ball probe	00760181	M3 fixation	Hardened steel ball tip
∅ 2,9 mm ball probe	00760182	M3 fixation	Hardened steel ball tip
∅ 1 mm ball probe	00760228	∅ 6 mm fixation	Shank and ball tip in hard metal
∅ 2 mm ball probe	00760229	∅ 6 mm fixation	Shank and ball tip in hard metal
∅ 3 mm ball probe	00760230	∅ 6 mm fixation	Shank and ball tip in hard metal
∅ 3 mm ball probe	00760061	∅ 6 mm fixation	Ball tip in hard metal
∅ 5 mm ball probe	00760227	∅ 6 mm fixation	Shank and ball tip in hard metal
∅ 10 mm ball probe	00760060	∅ 6 mm fixation	Ball tip in hard metal
∅ 1 mm ball probe	0071684818	∅ 8 mm fixation	Adjustable shank for depth measurement
∅ 4 mm ball probe	0071684815	∅ 8 mm fixation	Ball tip in hard metal
∅ 6 mm ball probe	0071684825	∅ 8 mm fixation	Ball tip in hard metal
∅ 6 mm ball probe	0071684816	∅ 8 mm fixation	Ball tip in hard metal
∅ 8 mm ball probe	0071684832	∅ 8 mm fixation	Ball tip in hard metal
∅ 10 mm ball probe	0071684817	∅ 8 mm fixation	Ball tip in hard metal
∅ 10 mm ball probe	0071684829	∅ 8 mm fixation	Ball tip in hard metal

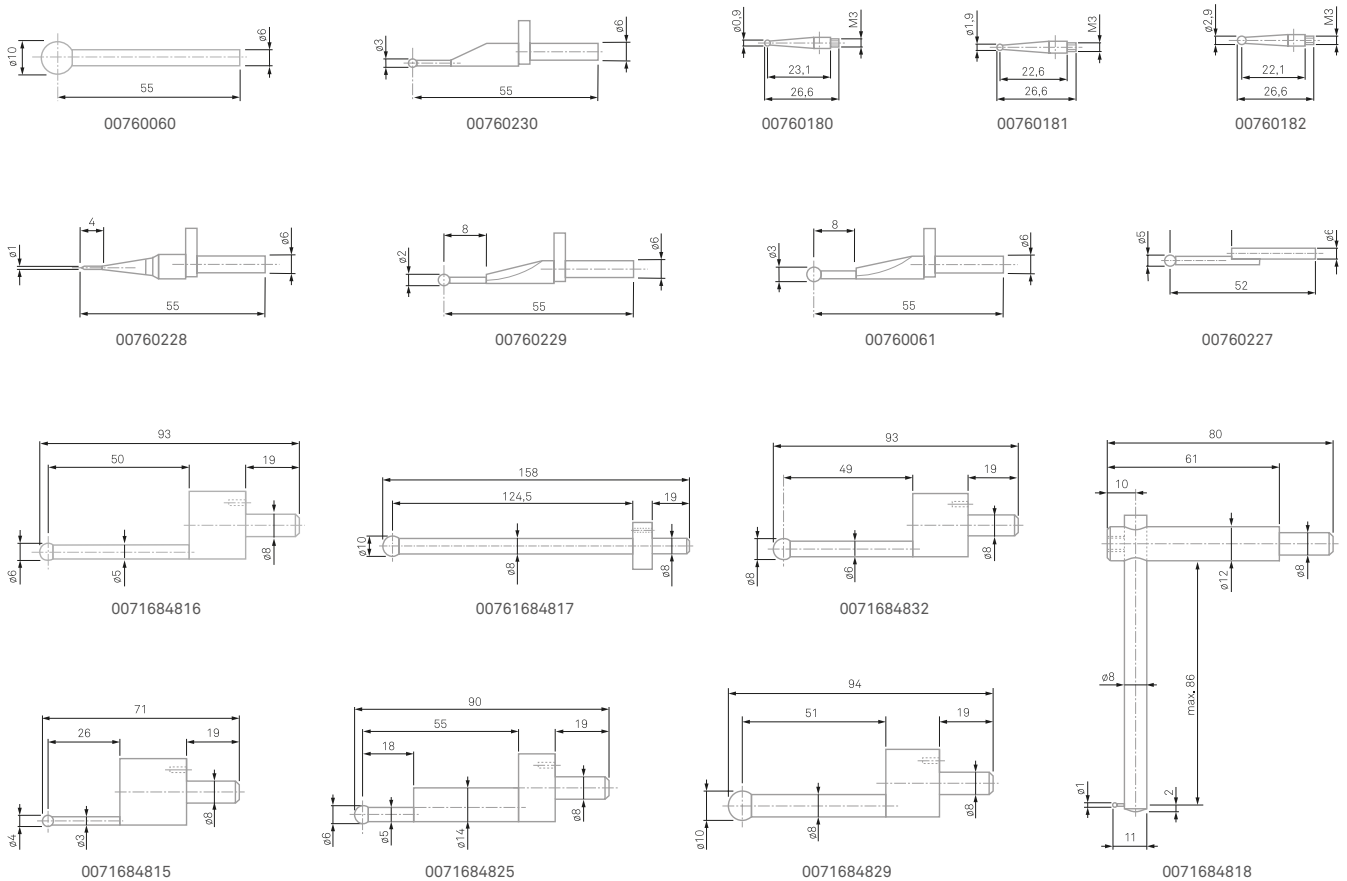

Disc probes

These probes have the form of a disc with a variable thickness and diameter, allowing the probing of centring shoulders and grooves. These accessories are often used in internal bore measurements because they are a good replacement when the star-shaped probes cannot be used.

Disc probe \varnothing 4,5 mm	00760074	\varnothing 6 mm fixation, hard metal disc
Disc probe \varnothing 14 mm	00760075	\varnothing 6 mm fixation, hard metal disc
Disc probe \varnothing 19 mm	00760076	\varnothing 6 mm fixation, hard metal disc
Disc probe \varnothing 12 mm	0071684827	\varnothing 8 mm fixation

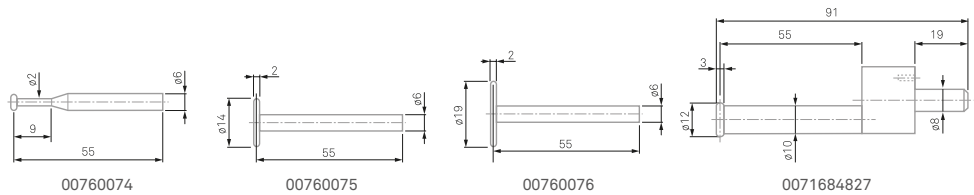

Cone probes

Cone probes are mainly used to determine the location of a bore since their form allows a quick positioning at the centre of these elements.

Cone probe \varnothing 8 mm	00760183	M3 fixation, hardened steel
Cone probe \varnothing 6 mm	0071684822	\varnothing 8 mm fixation, hardened steel
Cone probe \varnothing 22 mm	0071684819	\varnothing 8 mm fixation, hardened steel

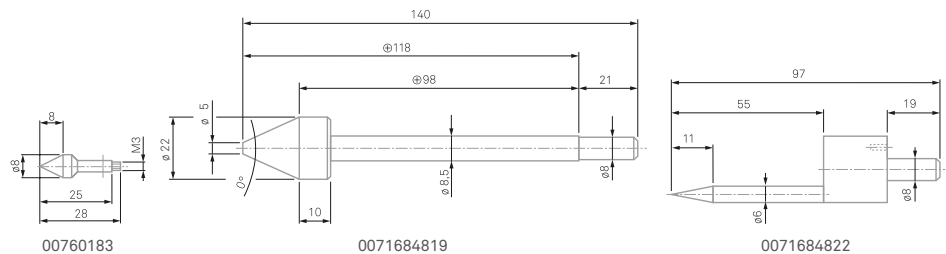

Shaft probes

The shaft probes are mainly used to measure grooves, centring shoulders, blind bores, ...

Probe inserts with a shank	00760094	hardened steel
Rod, angle 8°	00760178	hardened steel
Cylindrical rod	00760179	hard metal

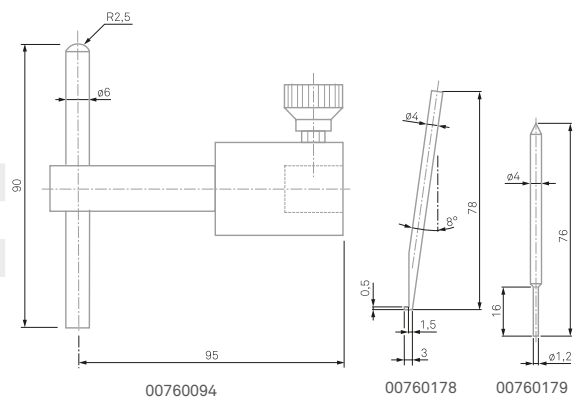

Cylindrical or barrel probes

The cylinder-shaped probes are often used to measure elements that cannot or hardly not easily be measured with a simple ball probe. In some instances, the contact between the accessory and the part to be measured cannot be guaranteed when the tip of the accessory is a ball. They are also used for the measurement of threads and often for the determination of the centre of tapped bores.

Barrel-shaped probe Ø 2,2 mm	00760066	Ø 6 mm fixation, hard metal measuring faces
Barrel-shaped probe Ø 4,5 mm	00760067	Ø 6 mm fixation, hard metal measuring faces
Barrel-shaped probe Ø 9,7 mm	00760068	Ø 6 mm fixation, hard metal measuring faces
Cylinder-shaped probe Ø 2 mm	00760082	Ø 6 mm fixation, hard metal measuring faces
Cylinder-shaped probe Ø 10 mm	00760093	Hardened steel housing, hard metal measuring faces
Cylinder-shaped probe Ø 10 mm	0071684820	Ø 8 mm fixation, steel

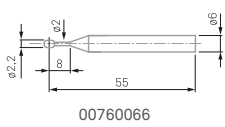

00760066

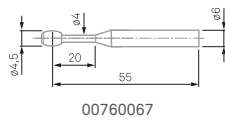

00760067

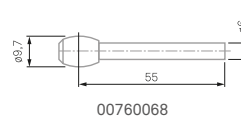

00760068

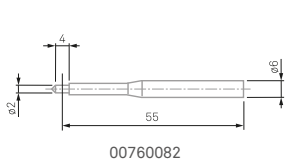

00760082

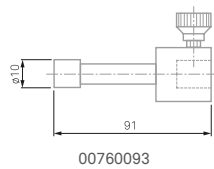

00760093

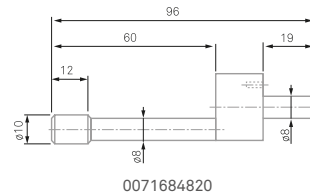

0071684820



Accessories for squareness measurement

The TESA-HITE can also contribute to the determination of perpendicularity deviations because these models are mechanically adjusted on their frontal plane. However, this application requires the use of several additional accessories such as an external display type TWIN-T10, an inductive probe and a support to mount it on the gauge.

Other configurations are also possible. For further details, please contact your local reseller.

Ø 8 mm probe support	00760222	For dial test indicator or 1D probe
GT 31 lever probe	03210801	Measuring range ±0,3 mm, force 0,02 N
GT 31 lever probe	03210802	Measuring range ±0,3 mm, force 0,1 N
GT 31 lever probe	03210803	Measuring range ±0,3 mm, force 0,2 N
GT 61 probe	03230041	Measuring range ±5 mm, force 0,9 N
TESA TWIN-T10 portable display	04430013	Integrated TLC port for data transmission

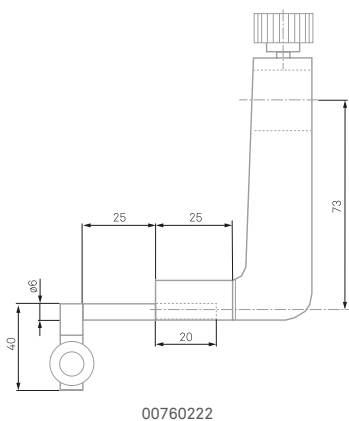

00760222



03230041

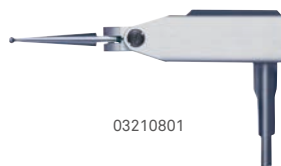

03210801



04430013

SETS OF ACCESSORIES

		Kit 1 4 elements 00760232	Kit 2 8 elements 00760173	Kit 3 17 elements 00760148	Kit 4 9 elements 00760175	
Composed of						
PROBE HOLDERS	00760057	Ø 6 mm probe holder to extend the application range		●		
	00760086	Ø 6 mm probe holder for depth up to 110 mm		●		
	00760087	Ø 6 mm probe holder for depth up to 185 mm		●		
	00760177	Adapter for M3 probes			●	
PROBES	00760060	Ø 10 mm ball probe, Ø 6 mm fixation		●	●	
	00760061	●	●	●		
	00760066	Ø 2,2 mm barrel-shaped probe, Ø 6 mm fixation		●		
	00760067	Ø 4,5 mm barrel-shaped probe, Ø 6 mm fixation		●		
	00760068	Ø 9,7 mm barrel-shaped probe, Ø 6 mm fixation		●		
	00760074	Ø 4,5 mm disc probe, Ø 6 mm fixation		●		
	00760075	●	●	●		
	00760076	Ø 19 mm disc probe, Ø 6 mm fixation		●		
	00760082	●		●		
	00760093	Ø 10 mm cylinder-shaped probe		●	●	
	00760094	●	●	●		
	00760180	Ø 0,9 mm ball probe, M3 fixation			●	
	00760181	Ø 1,9 mm ball probe, M3 fixation			●	
	00760182	Ø 2,9 mm ball probe, M3 fixation			●	
	00760183	Ø 8 mm cone probe, M3 fixation			●	
	00760228	Ø 1 mm ball probe, Ø 6 mm fixation		●	●	
	00760229	Ø 2 mm ball probe, Ø 6 mm fixation		●	●	
	00760230	Ø 3 mm ball probe, Ø 6 mm fixation		●	●	
	EXTENSIONS	00760184	Extension M3, L 20 mm			●
		00760185	Extension M3-M2,5, L 20 mm			●
SHAFT PROBES	00760178	Steel rod, angle 8°			●	
	00760179	Hard metal cylindrical rod			●	

OTHER ACCESSORIES

DATA MANAGEMENT	TESA DATA-DIRECT software	04981001	For data formatting
	TESA STAT-EXPRESS software	04981002	SPC software
	TESA DATA-VIEWER software	-	Downloadable free of charge from the TESA website
	Q-DAS software (qs-STAT, ...)	-	Please contact your local dealer
	TLC-DIGIMATIC CABLE	04760182	-
	TLC-USB CABLE	04760181	-
	TLC-BLE emitter(Bluetooth®)	04760184	-
	USB receiver + 1,5 m cable	04760185	For use with 04760184
TESA TLC-BLE starter kit	04760183	= 04760184 + 04760185	
CLEANING AND PROTECTION	Dust cover, 600 mm	00760152	-
	Dust cover, 900 mm	00760153	-
	Cleaning liquid	00760249	For granite table
ELECTRIC POWER SUPPLY	Charger	00760251	-
	Charger cable	04761055	For Europe
	Charger cable	04761056	For USA
	Charger cable	04761072	For UK
	Practice part	00760124	-

THE TESA SERVICE, OUR PRIORITY

For TESA, customer care is essential. To satisfy the most demanding metrological expectations of our clients and to help them find solutions is our daily challenge.



Calibration

To preserve the accuracy of measurement of your tools, TESA controls and calibrates your equipment and delivers a SCS accreditation (Swiss Calibration Service) or a TESA measuring report.



Repairs

Your height gauge needs to be repaired? TESA proposes quick solutions to repair, exchange and rent, if your equipment is under warranty or not.



Support

A product support and technical support are available for TESA equipment.



Training

A whole range of courses has been designed to meet your needs: user training during the installation, product training at TESA headquarters as well as on-site and customised trainings.



Maintenance

Work with peace of mind thanks to the preventive TESA maintenance contract to extend the life of your equipment and to preserve their precision.



Customization of the measuring inserts

For any requirements of specific measures, TESA proposes to customise your measuring insert according to your wishes.

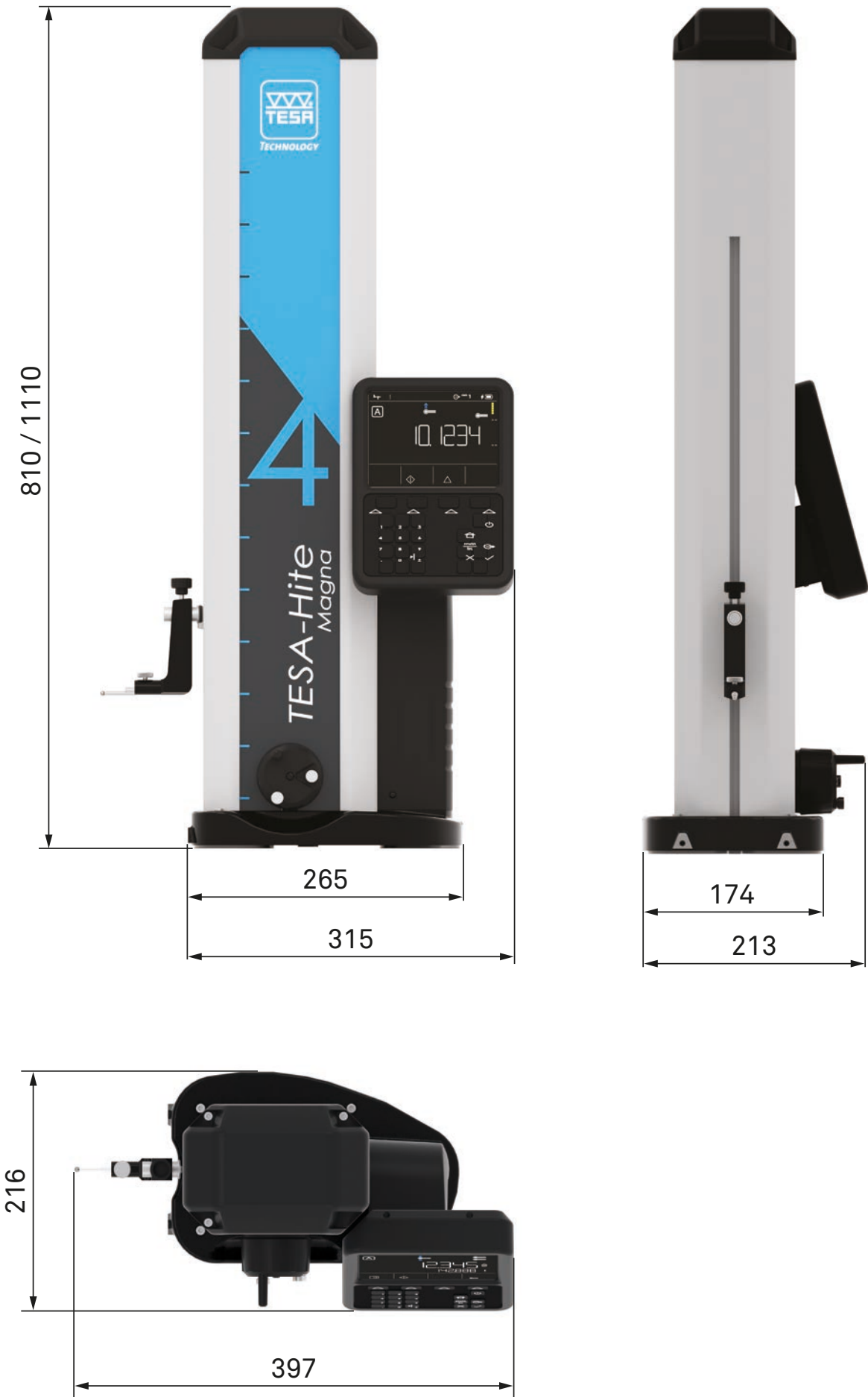



HEXAGON
MANUFACTURING INTELLIGENCE

Hexagon Manufacturing Intelligence helps industrial manufacturers develop the disruptive technologies of today and the life-changing products of tomorrow. As a leading metrology and manufacturing solution specialist, our expertise in sensing, thinking and acting – the collection, analysis and active use of measurement data – gives our customers the confidence to increase production speed and accelerate productivity while enhancing product quality.

Through a network of local service centres, production facilities and commercial operations across five continents, we are shaping smart change in manufacturing to build a world where quality drives productivity. For more information, visit HexagonMI.com.

Hexagon Manufacturing Intelligence is part of Hexagon (Nasdaq Stockholm: HEXA B; hexagon.com), a leading global provider of information technologies that drive quality and productivity across geospatial and industrial enterprise applications.

-  COORDINATE MEASURING MACHINES
-  3D LASER SCANNING
-  SENSORS
-  PORTABLE MEASURING ARMS
-  SERVICES
-  LASER TRACKERS & STATIONS
-  MULTISENSOR & OPTICAL SYSTEMS
-  WHITE LIGHT SCANNERS
-  METROLOGY SOFTWARE SOLUTIONS
-  CAD / CAM
-  STATISTICAL PROCESS CONTROL
-  AUTOMATED APPLICATIONS
-  MICROMETERS, CALIPERS, HEIGHT GAGES, ETC...
-  DESIGN AND COSTING SOFTWARE



TESA
TECHNOLOGY

Established in 1941 and headquartered in Renens, Switzerland, TESA SARL manufactures and markets precision measuring instruments that stand for quality, reliability and longevity.

For more than 75 years, TESA has distinguished itself in the market through its excellent products, its unique expertise in micromechanics and precision machining as well as its proven experience in dimensional metrology.

The TESA brand is the global market leader in the field of height gauges and a pioneer thanks to its wide range of instruments, including callipers, micrometers, dial gauges,

lever-type dial test indicators and inductive probes. TESA is a true benchmark for the inspection of incoming goods, as well as for production workshops and quality assurance laboratories.

Through its worldwide distribution network the company focuses on the mechanical engineering, micromechanical, automotive, aerospace, watchmaking and medical industries. In 2001, TESA became part of Hexagon, a leading global provider of information technologies.

TESAtechnology.com



ZIBTRPRO
tehnologija obdelave · vpenjalni sistemi