

RX

EXTRA COMPACT STEADY REST

Extra compact design
Large clamping range
Integrated cylinder
Integrated coolant flush
Highest centering accuracy



Technical Data
www.smw-autoblok.de/qr/rx



SMW-AUTOBLOK

Extra compact steady rest

Type RX



Double curve system

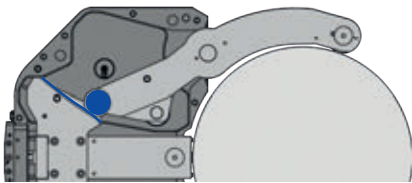

Cam 1 is driving **roller 1**.
They cover the first 50 % of the clamping stroke.

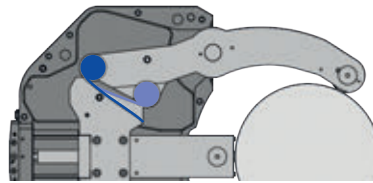

Cam 2 and **roller 2** are taking over in the transition zone between **Cam 1** and **Cam 2**.

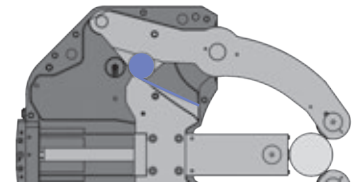

Cam 2 is driving **roller 2**.
They cover the second 50 % of the clamping stroke.

Features included in standard range

Steady Rest Type	Premium Line
	RX
Steady Rest Size	5 - 6.1
Sealed body	■
Safety valve (integrated in pressure booster)	■
Stroke control (proximity switch not included)	■
1 set swarf guard with integrated coolant flush	■
1 set cylindrical rollers	■
Port for compressed air	■
Port for coolant through arms incl. chipguard	■
Toolbox	■

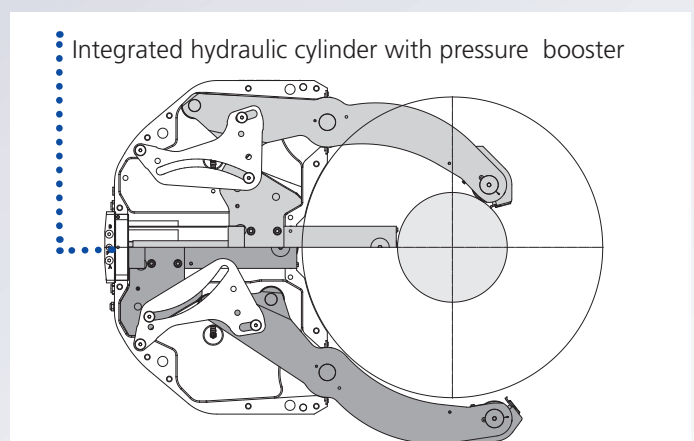

Size comparison

SR 6
Clamping range
125 - 460 mm

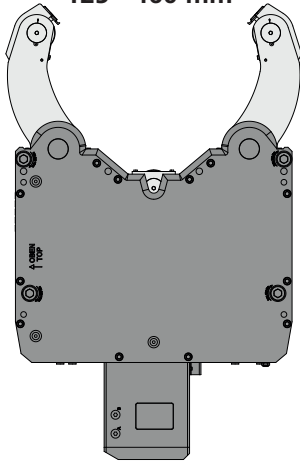

K 6.1
Clamping range
215 - 510 mm

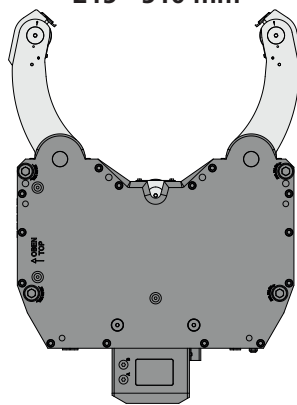

RX 6
Clamping range
100 - 520 mm

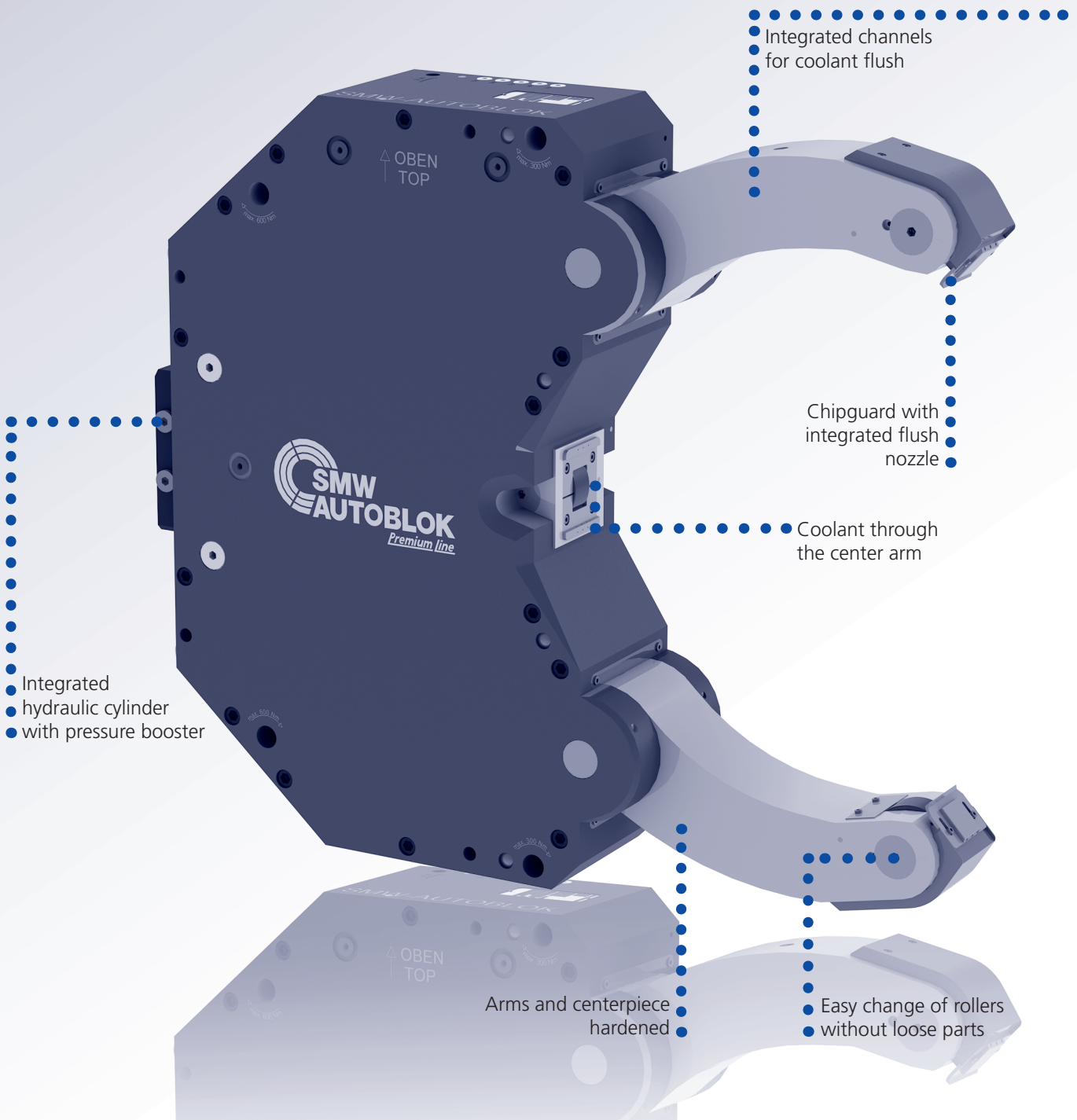
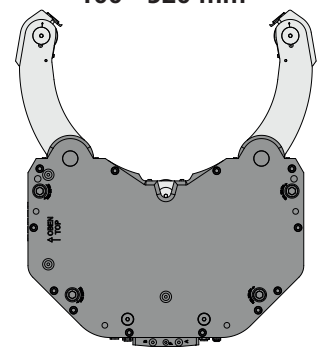

● Integrated channels for coolant flush

● Chipguard with integrated flush nozzle

● Coolant through the center arm

● Integrated hydraulic cylinder with pressure booster

● Arms and centerpiece hardened

● Easy change of rollers without loose parts

- Sealed body
- Integrated cylinder
- Stroke control with proximity switch

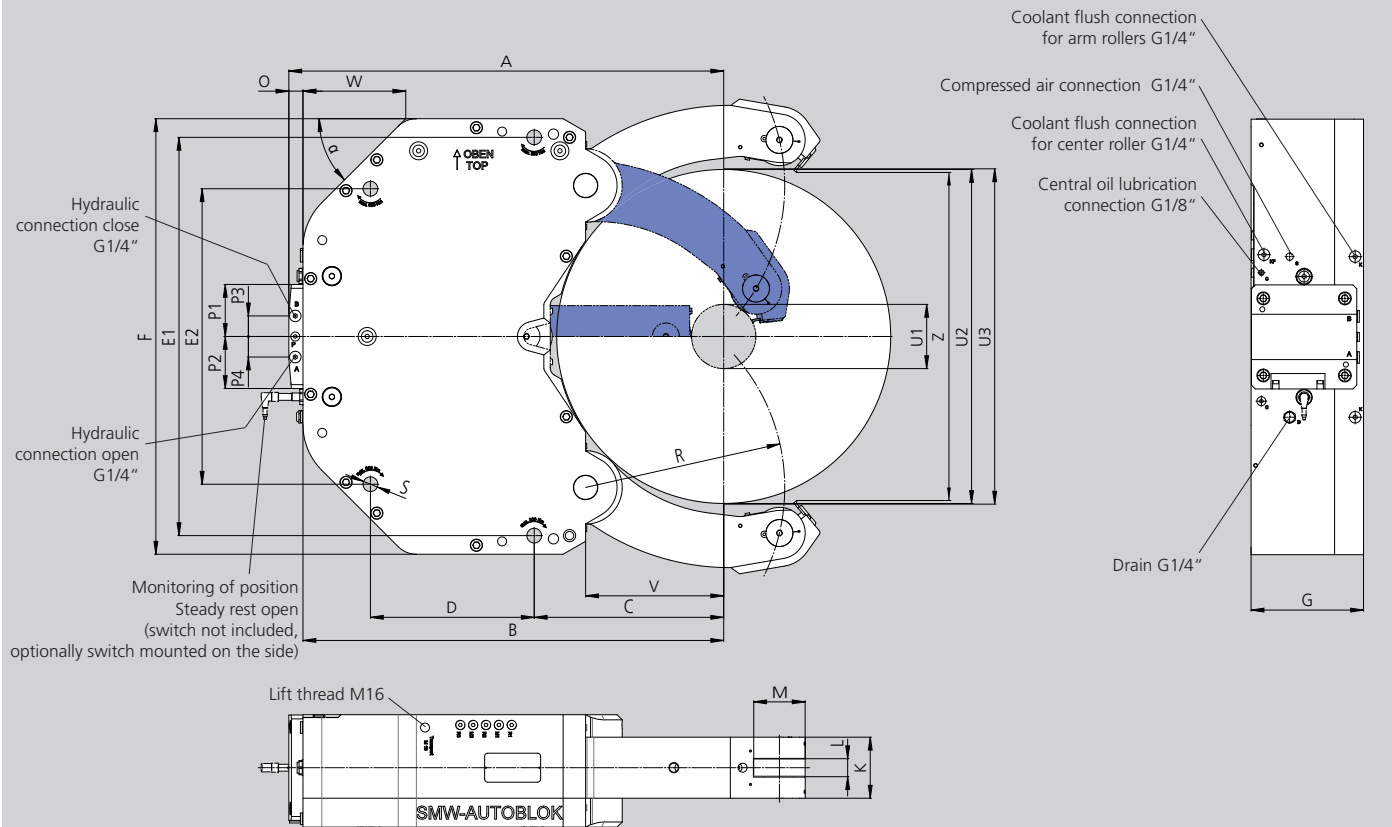

Subject to technical changes.
For more detailed information please ask for customer drawing.

SMW-AUTOBLOK Type Size		RX 5	RX 6	RX 6.1	
Centering range with coolant chip guard	U1	75	100	250	
Max. clamping diameter*	U2	430	520	685	
Max. axial clearing diameter	U3	432	522	687	
	A	599	677	792	
	B	577	655	770	
	C	225	295	370	
	D	235	255	290	
	E1	490	620	720	
	E2	360	460	520	
	F	530	678	760	
	G	165	175	175	
	K	85	95	95	
Width of rollers	L	29	29	29	
Diameter of rollers	M	62	80	80	
	O	22	22	22	
	P1	81	81	81	
	P2	81	81	81	
	P3	30	30	30	
	P4	30	30	30	
	R	270	310	395	
	S	23	23	23	
	V	200	215	285	
	W	175	160	197	45.6
	Z	432	510.6	682	
	α	38°	45°	40°	60°
Piston area	cm ²	12.56	19.63	19.63	
Operating pressure min./max. **	bar	65	60	60	
Max. clamping force/roller	daN	2000	3000	3000	
Centering accuracy over the whole range	mm	0.07	0.07	0.07	
Repeatability accuracy	mm	0.01	0.01	0.01	
Max. roller surface speed	m/min	600	560	560	
Weight approx.	kg	190	295	325	

* Radial loading is possible, if only 1 chip guard is used.

** 450 bar in the cylinder created by the pressure booster (ratio 1:7.5)

RXSelf-centering Steady Rests
Premium Line

- Ordering review
- Accessories
- Wearing parts

RX Steady Rest with stroke control Steady Rest open via proximity switch (without proximity switch)***

Steady Rest size		5	6	6.1
RX-M manual lubrication	Id. No.	on request	on request	on request
RX-Z central lubrication oil	Id. No.	224200	224140	224220
RX-OLD central lubrication oil + air	Id. No.	on request	on request	on request
RX-F central grease lubrication	Id. No.	on request	on request	on request

RX Steady Rest with stroke control via linear stroke control SCU-A, output 4–20 mA













Steady Rest size		5.1	6	6.1
RX-M manual lubrication	Id. No.	on request	on request	on request
RX-Z central lubrication oil	Id. No.	on request	on request	on request
RX-OLD central lubrication oil + air	Id. No.	on request	on request	on request
RX-F central grease lubrication	Id. No.	on request	on request	on request

RX Steady Rest with stroke control via linear stroke control SCU-V, output 1–10 V

Steady Rest size		5	6	6.1
RX-M manual lubrication	Id. No.	on request	on request	on request
RX-Z central lubrication oil	Id. No.	on request	on request	on request
RX-OLD central lubrication oil + air	Id. No.	on request	on request	on request
RX-F central grease lubrication	Id. No.	on request	on request	on request

Type RX

◆ denotes wearing parts, recommended stock items

Steady Rest size		5	6	6.1
Compact lubrication system for oil pressure lubrication Container 2.7 l, 220 V *,**		088707	088707	088707
Compact lubrication system for oil + air lubrication Container 2.7 l, 220 V *,**		088708	088708	088708
Eccenter fine adjustment compl. at lever arm (2 pcs. per Steady Rest) manual/central lubrication		224193	224196	224196
Inductive limit switch		087926	087926	087926
Swarf guard coolant/air with wiper		125816	125837	125837
Wiper for swarf guard coolant/air	 ◆	126888	126694	126694
Roller stripper for middle piece	 ◆	200152	203268	203268
Roller cylindrical design	 ◆	018345	026594	026594
Roller spherical design	 ◆	019545	121302	121302
Roller synthetic material ****	 ◆	023650	on request	on request
Roller stripper (2-pieces) for middle piece with roller synthetic material	 ◆	204216	-	-
Roller carbide	 ◆	222038	on request	on request
Adjustment device 1 set = 3 pcs.		200179	200179	200179

* When placing an order, please advise voltage

** On request 110 V available

*** Stroke control open / closed on request

**** Attention: Reduced clamping force! Please refer to the clamping force value marked on the roller.



SMW-AUTOBLOK Spannsysteme GmbH
Postfach 1151 • D-88070 Meckenbeuren
Wiesentalstraße 28 • D-88074 Meckenbeuren
Tel.: +49 (0) 7542 - 405 - 0

Vertrieb Inland:
Fax: +49 (0) 7542 - 3886
E-mail ➤ vertrieb@smw-autoblok.de

Sales International:
Fax: +49 (0) 7542 - 405 - 181
E-mail ➤ sales@smw-autoblok.de



www.smw-autoblok.de