

**NEW**



more than  
**70**  
YEARS  
quality  
in Europe

precision measuring instruments  
**mechanical - optical - electronical**

**New products**

**Revision date: September 2022**



**NEW**

## Digital Caliper with long measuring jaw

Digital caliper with long measuring jaw for use as scribing tool.

- Measuring range: 0 - 150 mm.
- Resolution: 0.01 mm.
- mm/inch conversion.
- On/off switch.
- Reset.
- Large LCD display.
- Locking screw/flat depth rod.
- Tungsten carbide measuring faces.
- Power supply: 1 battery type V357.



*Filetta*

**NEW**

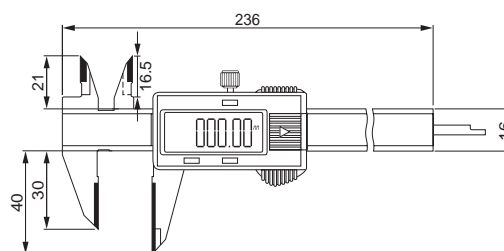
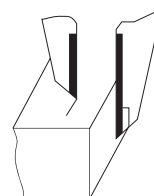

Item No.	Measuring range/mm	Price EUR
910.284	0 - 150	85.00
<b>Option:</b> 836.535 Spare battery		0.80

## Digital caliper with pin-shaped anvil

Digital caliper for measuring e.g. (tube) wall thickness.

- Measuring range: 0 - 150 mm.
- Resolution: 0.01 mm.
- mm/inch conversion.
- On/off switch.
- Reset.
- Large LCD display.
- Pin-shaped anvil:  $\varnothing 4$  mm.
- Locking screw.
- Power supply: 1 battery type V357.



*Filetta*

**NEW**

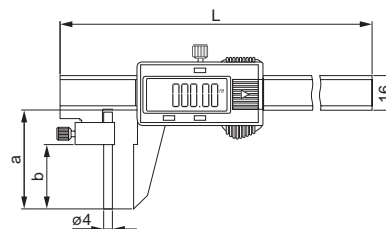
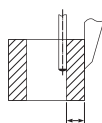

Item No.	Measuring range/mm	a mm	b mm	Price EUR
910.262	0 - 150	46	30	108.00
<b>Option:</b> 836.535 Spare battery				0.80

**NEW**

### Digital radius caliper

Digital caliper for direct measurement of a radius for an arc that has an opening angle smaller than 180° (min. 107°).

- Measuring range: 3 - 150 mm.
- Resolution: 0.01 mm.
- mm/inch conversion.
- On/off switch.
- Reset.
- Large LCD display.
- Locking screw.
- Power supply: 1 battery type V357.



*Filetta*

**NEW**

PRICE

Item No.	Measuring range/mm	Price EUR
910.272	3 - 150	174.00
<b>Option:</b> 836.535	Spare battery	0.80

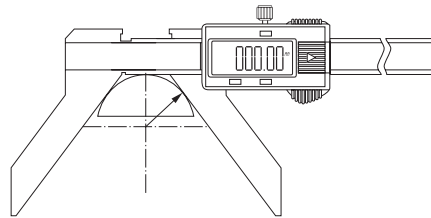

### Digital calipers with long measuring knives

Digital calipers with long measuring knives for internal measurements.

- Measuring range: 0 - 200 mm.
- Resolution: 0.01 mm.
- mm/inch conversion.
- On/off switch.
- Reset.
- Large LCD display.
- Locking screw/flat depth rod.
- Power supply: 1 battery type V357.

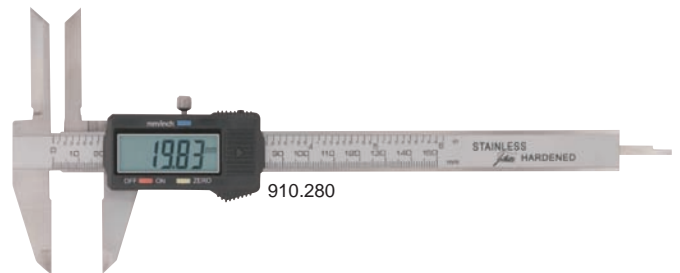

910.280

*Filetta*

**NEW**

PRICE

Item No.	Measuring range/mm	C mm	A mm	Price EUR
910.280	0 - 150	35	40	119.00
910.281	0 - 200	40	50	128.00
<b>Option:</b> 836.535	Spare battery			0.80

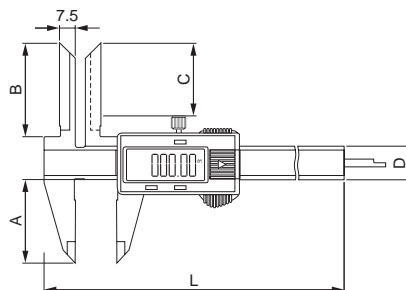



**NEW**

## Universal digital calipers

Large universal digital calipers for internal and external measurements.

In combination with these universal calipers many inserts are available e.g. for internal/external measurements or measuring center distances between bores up to  $\varnothing 14.5$  mm.

- Internal measuring range<sup>1</sup>: 20-300 mm.
- External measuring range<sup>1</sup>: 0-300 mm.
- Resolution: 0.01 mm.
- mm/inch conversion.
- On/off switch.
- Reset.
- Large LCD display.
- Locking screw.
- Power supply: 1 battery type V357.
- Delivery without inserts.



910.285

**NEW**

Item No.	Measuring range/mm		Price EUR
	internal <sup>1</sup>	external <sup>1</sup>	
910.285	20-200	0-200	197.00
910.286	20-300	0-300	255.00
<b>Option:</b>			
836.535	Spare battery		0.80

<sup>1</sup> The measuring range can change depending on inserts.

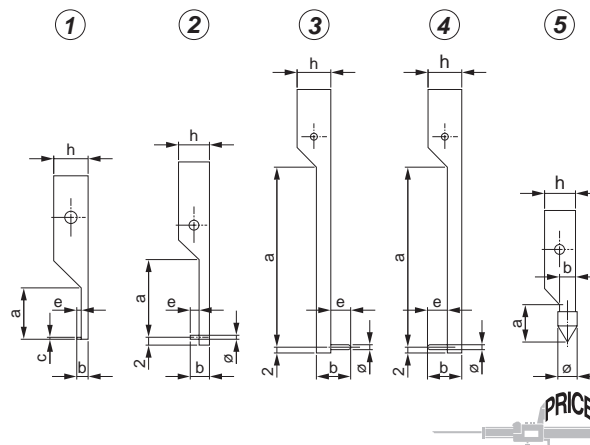

### Inserts

No.	Item No.	Description	Length/mm					ø mm	Price EUR
			a	b	c	e	h		
①	910.287	For internal/external measurements	12	2.5	0.4	1	8	42.00	
①	910.288	For internal/external measurements	16	3.5	0.4	2	8	42.00	
①	910.289	For internal/external measurements	25	7.5	0.6	5	8	42.00	
①	910.290	For internal/external measurements	30	10	1	6.5	8	42.00	
①	910.292	For internal/external measurements	80	22	1	10	12	47.00	
②	910.293	For internal/external measurements	20	5		2	8	1	48.00
②	910.294	For internal/external measurements	40	10		5	8	2	48.00
②	910.295	For internal/external measurements	80	22		10	12	2	50.00
③	910.296	For external measurements	70	12		7	12	2	58.00
③	910.297	For external measurements	70	12		7	12	4	58.00
④	910.298	For internal measurements	70	12		7	12	2	58.00
④	910.299	For internal measurements	70	12		7	12	4	58.00
⑤	910.300	For center distances	10	4	-		8	5	75.00
⑤	910.301	For center distances	20	4	-		8	10	77.00
⑤	910.302	For center distances	25	8	-		12	15	82.00

*Filetta*

**NEW**

## Universal digital calipers

Universal digital calipers with exchangeable measuring inserts for special purposes. Thanks to the seven interchangeable measuring inserts, which are available as an option, you are very flexible with these universal calipers.

- Internal measuring range<sup>1</sup>: 40 - 500 mm.
  - External measuring range<sup>1</sup>: 0 - 500 mm.
  - Resolution: 0.01 mm.
  - mm/inch conversion.
  - On/off switch.
  - Reset.
  - Large LCD display.
  - Locking screw.
  - Power supply: 1 battery type V357.
  - Standard supplied with measuring insert 1.
- Only 910.306:
- Absolute digital display.
  - Reset/preset.
  - Power supply: 1 battery type CR2032.



910.303



PRICE

Item No.	Measuring range/mm internal <sup>1</sup> external <sup>1</sup>	a/mm	b/mm	Price EUR
910.303	40 - 150 0 - 150	45	7	160.00
910.304	40 - 200 0 - 200	85	10	187.00
910.305	40 - 300 0 - 300	100	15	248.00
910.306*	40 - 500 0 - 500	140	20	491.00

**Options:**

836.535	Spare battery type V357	0.80
495.157	Spare battery type CR2032	0.50

<sup>1</sup> The measuring range can change depending on inserts. The measuring range indicated is with standard inserts.

No.	Item No.	Description measuring faces	Price EUR
<b>Measuring inserts, per pair:</b>			
①	906.788	flat	15.40
②	906.789	spherical	18.50
③	906.790	small	27.70
④	906.791	disc	27.70
⑤	906.792	knife/flat	36.90
⑥	906.793	point	27.70
⑦	906.794	knife	46.00
	906.795	Set of 7 pairs	156.00

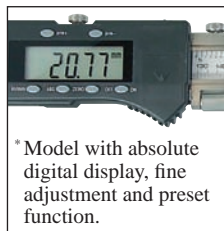
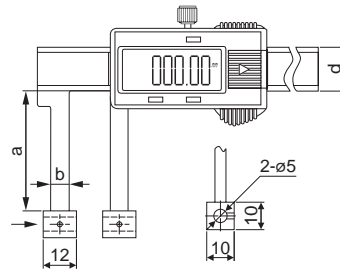

\* Model with absolute digital display, fine adjustment and preset function.

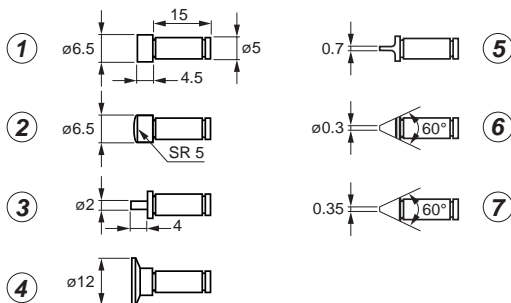



**NEW**

## Universal digital calipers

Universal digital calipers with interchangeable measuring inserts for varying purposes. By using M2.5 thread, many different measuring inserts can be used in combination with these calipers. Please see the dial indicator accessories for these inserts.

- Internal measuring range<sup>1</sup>: 20-500 mm.
  - External measuring range<sup>1</sup>: 0-500 mm.
  - Resolution: 0.01 mm.
  - mm/inch conversion.
  - On/off switch.
  - Reset.
  - Large LCD display.
  - Locking screw.
  - Power supply: 1 battery type V357.
  - Standard supplied without inserts.
- Only 910.333:
- Absolute digital display.
  - Reset/preset.
  - Power supply: 1 battery type CR2032.



910.330



**NEW**

Item No.	Measuring range/mm internal <sup>1</sup> external <sup>1</sup>	Jaw length mm	Price EUR
910.330	20-150 0-150	45	162.00
910.331	25-200 0-200	85	189.00
910.332	30-300 0-300	90	251.00
910.333*	35-500 0-500	150	497.00

**Options:**

836.535	Spare battery type V357	0.80
495.157	Spare battery type CR2032	0.50

<sup>1</sup> The measuring range can change depending on inserts.

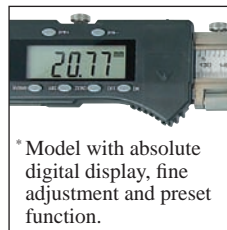

\* Model with absolute digital display, fine adjustment and preset function.

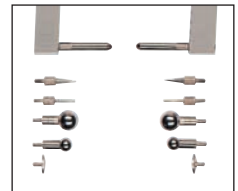
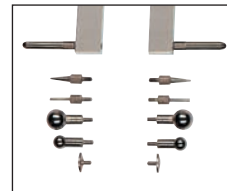

Inserts examples. For more information see the dial indicator accessories section.

*Filletta*

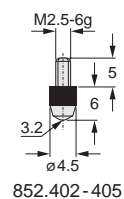
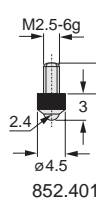
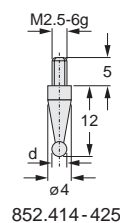
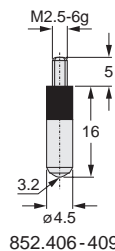
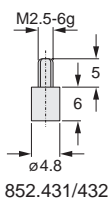
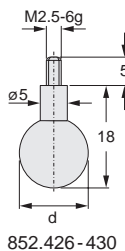

**NEW**

## Measuring instruments set

For specifications see relevant pages elsewhere in this catalog.

- Digital caliper 906.838: measuring range 0-150 mm, resolution 0.01 mm.
- Digital micrometer 906.862: measuring range 0-25 mm, resolution 0.001 mm, with tolerance indication.
- Bevelled edge square 907.252: dimensions 100x70 mm, DIN 875/00.
- Delivered in a plastic carrying case.

*Filetta*

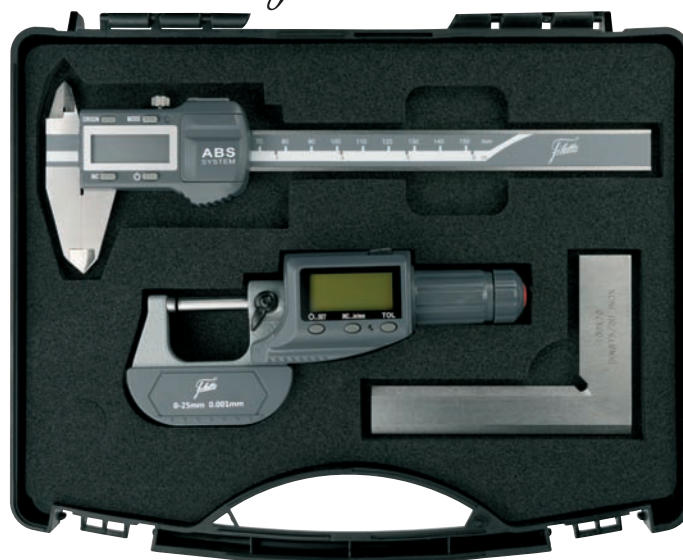
**NEW****PRICE**

Item No.	Description	Price EUR
910.338	Meas. instruments set	125.00

## Measuring instruments set

For specifications see relevant pages elsewhere in this catalog.

- Caliper 909.521: measuring range 0-150 mm, vernier 0.05 mm.
- Micrometer 906.000: measuring range 0-25 mm, graduation 0.01 mm.
- Bevelled edge square 907.252: dimensions 100x70 mm, DIN 875/00.
- Ruler 835.421: measuring range 0-150 mm, graduation 0.5 mm.
- Delivered in a plastic case.

*Filetta*

**NEW****PRICE**

Item No.	Description	Price EUR
910.339	Meas. instruments set	59.00



**NEW**

## Digital carbon workshop calipers IP65

Workshop calipers with large measuring jaws, Bluetooth, and an ultra lightweight carbon fiber construction that saves up to 65% of the total weight compared to a steel workshop caliper.

- Measuring range: 0 - 2000 mm.
  - Resolution: 0.01 mm.
  - mm/inch conversion.
  - ABS/INC switchable.
  - Digimatic data output.
  - Bluetooth data output.
  - On/off switch.
  - Reset/preset.
  - Hold function.
- 
- Fine adjustment by means of carriage for constant measuring force between 5 - 10 N.
  - Carbon jaws with steel measuring faces.
  - Rounded jaw ends for internal measurements.
  - Locking screw.
  - Protection: IP65.
  - Delivered in a wooden case with a manufacturer measuring report.
  - Power supply: 1 battery type CR2032.

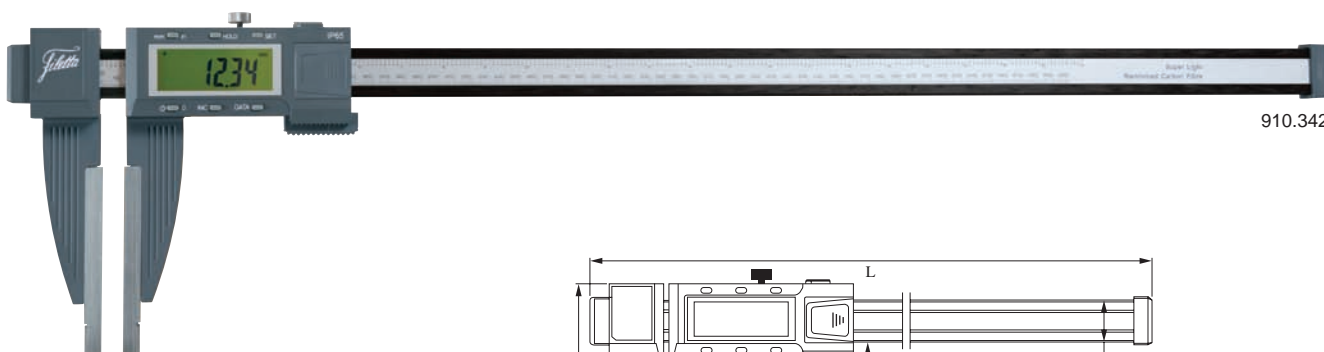

**NEW**

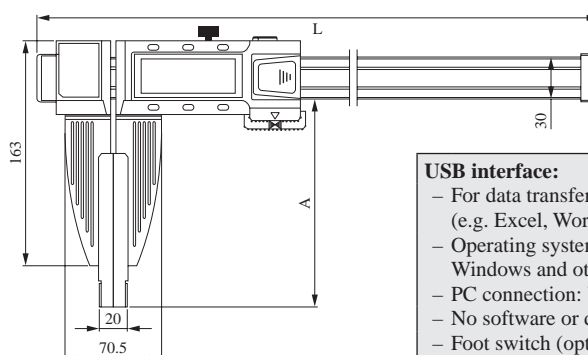

**USB interface:**

- For data transfer to PC (e.g. Excel, Word).
- Operating system: Windows and other.
- PC connection: USB.
- No software or driver to install.
- Foot switch (optional).



Item No.	Measuring range/mm	Accuracy mm	Jaw length A/mm	Weight kg	Length L/mm	Price EUR
910.342	0- 600	±0.06	150	1.3	826	392.00
910.343	0- 600	±0.08	200	1.4	826	454.00
910.344	0- 600	±0.12	300	1.5	826	520.00
910.345	0- 1000	±0.08	150	1.5	1226	546.00
910.346	0- 1000	±0.12	200	1.6	1226	628.00
910.347	0- 1000	±0.16	300	1.7	1226	703.00
910.348	0- 1000	±0.25	500	1.9	1226	
910.349	0- 1500	±0.16	200	2.0	1736	846.00
910.350	0- 1500	±0.21	300	2.1	1736	953.00
910.351	0- 1500	±0.36	500	2.3	1736	
910.352	0- 2000	±0.21	200	2.6	2246	1,675.00
910.353	0- 2000	±0.25	300	2.7	2246	1,842.00
910.354	0- 2000	±0.42	500	2.9	2246	

**Options:**

495.157	Spare battery	0.50
909.686	USB interface	105.00
909.687	Footswitch for USB interface	18.00
910.038	Wireless USB receiver	48.00
910.039	Wireless transmitter	48.00

*Filetta*



**NEW**

## Wooden cases for calipers

Wooden cases of high quality with foam inlay for calipers.



836.416

Item No.	Inside dimensions <i>l x w x h</i> /mm	Price EUR
836.455	250 x 90 x 20	7.70
836.437	315 x 145 x 20	9.20
836.416	435 x 175 x 20	16.00
836.406	610 x 180 x 20	27.00
836.400	690 x 200 x 20	46.70
836.349	690 x 250 x 25	47.90
836.387	790 x 200 x 25	50.00
836.399	1000 x 270 x 25	66.00
841.305	1100 x 480 x 25	86.00

**NEW**



**NEW**

## Digital depth calipers with with round depth rod

Universal depth calipers with round depth rod with M2.5 threaded hole for exchangeable inserts. Inserts with M2.5 thread can be used with these calipers. Please see the dial indicator accessories section for these inserts.

- Measuring range: 0 - 150 mm.
- Diameter depth rod: 4 mm.
- Resolution: 0.01 mm.
- mm/inch conversion.
- On/off switch.
- Reset.
- Large LCD display.
- Locking screw.
- Length measuring base: 85 mm.
- Interchangeable measuring inserts: disc attachment included  $\varnothing 8$  mm,  $d = 1$  mm.
- Power supply: 1 battery type V357.



**NEW**

Item No.	Measuring range/mm	Price EUR
910.355	0 - 100	144.00
910.356	0 - 150	179.00
<b>Option:</b>		
836.535	Spare battery	0.80

## Digital depth gauge

Digital tire tread depth gauge made of high quality plastic.

- Measuring range: 0 - 25 mm.
- Resolution: 0.01 mm.
- mm/inch conversion.
- On/off switch.
- Reset.
- Large LCD display.
- Measuring face: 60 x 5.7 mm.
- Measuring pin:  $\varnothing 4$  mm.
- Measuring tip: 2.6 x 0.9 mm.
- Power supply: 1 battery type V357.

*Filetta*



**NEW**

Item No.	Measuring range/mm	Price EUR
910.357	0 - 25	13.60
<b>Option:</b>		
836.535	Spare battery	0.80

## Depth caliper for keyway depths

- Measuring range: keyway depths 0 - 25 mm.
- Application range: cylinders  $\varnothing 5 - 200$  mm.
- Resolution: 0.01 mm.
- mm/inch conversion.
- On/off switch.
- Reset.
- Large LCD display.
- Locking screw.
- Measuring pin:  $\varnothing 2$  mm.
- Power supply: 1 battery type V357.

*Filetta*



**NEW**

Item No.	Application range/mm	Price EUR
910.258	$\varnothing 5 - 200$	170.00
<b>Option:</b>		
836.535	Spare battery	0.80

**NEW**

### Digital quick thickness gauges

- Measuring range: 0 - 25 mm.
- Resolution: 0.01 mm.
- Accuracy 910.313:  $\pm 0.03$  mm.
- Accuracy 910.314:  $\pm 0.04$  mm.
- mm/inch conversion.
- On/off switch.
- Reset.
- Anvil 910.313:  $\varnothing 6.3$  mm.
- Pin measuring face 910.313:  $\varnothing 5$  mm.
- Measuring face 910.314:  $\varnothing 5$  mm.
- Power supply: 1 battery type V357.



**NEW**

**PRICE**

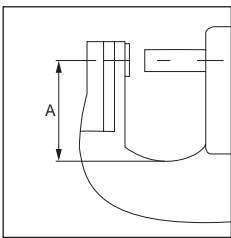

*Filetta*

Item No.	Measuring range/mm	Throat depth A/mm	Price EUR
910.313	0 - 12	19.7	127.00
910.314	0 - 25	25	164.00
<b>Option:</b> 836.535 Spare battery			0.80

### Digital indicators

- Measuring range: 0 - 100 mm.
- Resolution: 0.01 mm.
- mm/inch conversion.
- On/off switch.
- Reset.
- Clamping shaft:  $\varnothing 6$  mm.
- Clamping stem:  $\varnothing 8$  mm.
- Power supply: 1 battery type V357.



*Filetta*

**NEW**

**PRICE**

Item No.	Measuring range/mm	Measuring force/N	Total length/mm	Price EUR
910.311	0 - 50	< 2.5	148	145.00
910.312	0 - 100	< 3.2	330	154.00
<b>Option:</b> 836.535 Spare battery				0.80





**NEW**

## Dial bore gauge for through bores

Dial bore gauge consisting of a grip (clamping shaft  $\varnothing$  8 mm), with a two point split contact point with a needle.

- Measuring range: 3 - 18 mm.
- Measuring elements: hardened steel.
- Measuring needles: hardened steel.
- Including standard dial indicator 0 - 3 mm / 0.01 mm.
- Constant measuring force as a result of a built-in spring, thus eliminating user influence.
- Delivery in plastic case.



910.329

*Filetta*

**NEW**



Item No.	Measuring range/mm	Measuring depth/mm	Number of inserts	Price EUR
910.326	3 - 4	20	4	391.00
910.327	4 - 6	30	4	314.00
910.328	6 - 10	40	4	214.00
910.329	10 - 18	130	8	229.00

## Digital dial indicators

Digital dial indicators with digital and digital-analog read-out.

- Measuring range: 0 - 15 mm.
- Resolution: 0.002 or 0.0005 mm.
- mm/inch conversion.
- ABS/INC switchable.
- On/off switch.
- USB-C data output (only 910.340): for data transfer to PC (e.g. Excel, Word), operating system Windows and other.
- Multifunctional functions (Only 910.340): automatic switch-off, hold-function, adjustable tolerance limits, reversible measuring direction, min/max-function.
- Reset/preset.
- Clamping stem:  $\varnothing$  8 mm.
- Dial diameter: 62 mm.
- Dial 315° rotatable (Except 910.340: 270°).
- With determination of the reversal point.
- Protection (only 910.340): IP54.
- Delivered in a plastic case (only 910.340: With USB-C, charger and a manufacturer measuring report).
- Power supply: 1 battery type CR2032 (Except 910.340, rechargeable battery).

*Filetta*



909.251

910.340

**NEW**

Item No.	Measuring range/mm	Resolution mm	Accuracy mm	Measuring force/N	Price EUR
909.250	0 - 12.5	0.002	$\pm 0.015$	1.2	109.00
909.251	0 - 12.5	0.0005	$\pm 0.006$	1.2	204.00
910.340	0 - 15	0.0005	$\pm 0.002$	1.5	305.00
<b>Option:</b>					
495.157	Spare battery				0.50

**NEW**

### Bridges

A number of standard bridges have been developed for arithmetic indicators to provide several convenient measuring solutions. The accuracy depends on the radius and form deviation of the workpiece. Custom-made bridges are also possible.

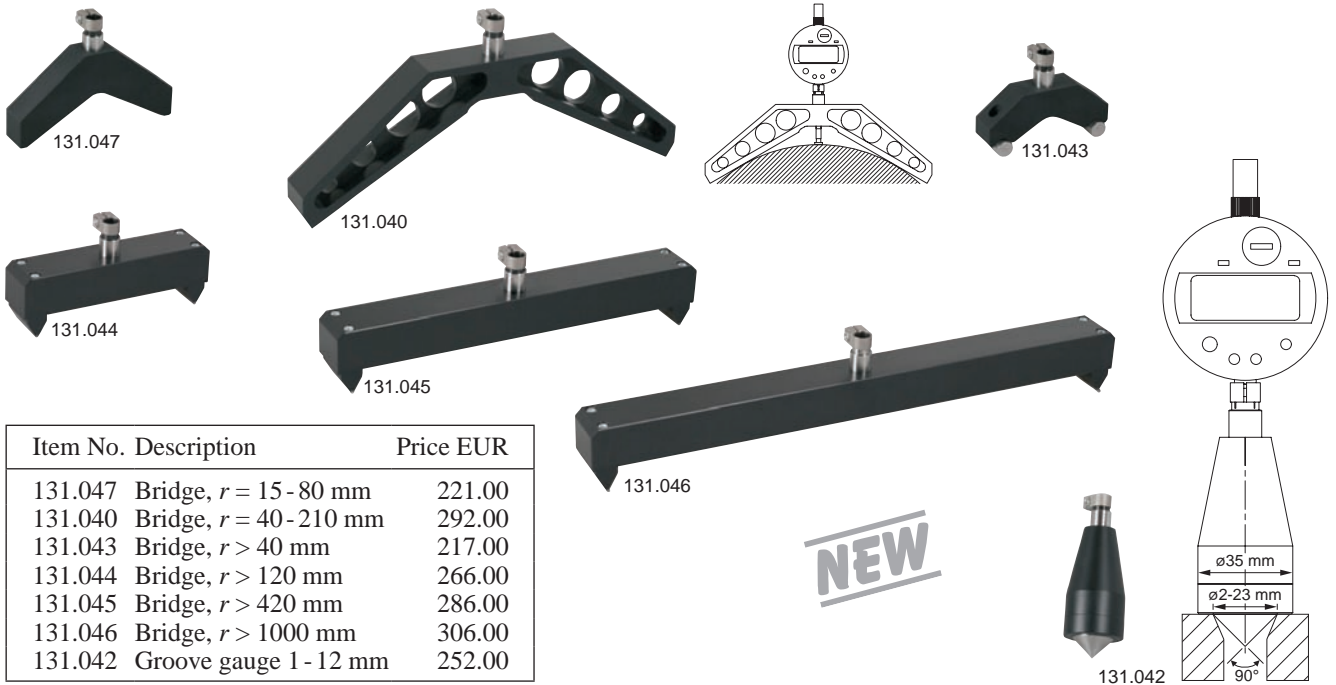

Item No.	Description	Price EUR
131.047	Bridge, $r = 15 - 80$ mm	221.00
131.040	Bridge, $r = 40 - 210$ mm	292.00
131.043	Bridge, $r > 40$ mm	217.00
131.044	Bridge, $r > 120$ mm	266.00
131.045	Bridge, $r > 420$ mm	286.00
131.046	Bridge, $r > 1000$ mm	306.00
131.042	Groove gauge 1 - 12 mm	252.00

### Center-accessory

Small magnetic dial indicator stand which, in combination with a lever, could also be used as center-accessory to align bores in workpieces. For use in combination with a machine center.

- Permanent magnet  $\varnothing 25$  mm.
- Universal pivot with dovetail clamp.
- Fine adjustment.
- Cylindrical support  $\varnothing 10$  mm for insert in the collet chuck of a machine center.



Item No.	Description	Price EUR
910.341	Center-accessory	22.30
960.490	Cylindrical support	16.50



**NEW**

## Wooden cases for straight edges

Wooden cases of high quality with foam inlay for straight edges and rulers up to 2.5 meters.



776.568

**NEW**

Item No.	Inside dimensions <i>l x w x h</i> /mm	Price EUR
776.568	525 x 70 x 35	47.00
776.263	765 x 70 x 30	63.00
776.468	1025 x 80 x 35	70.00
776.561	1525 x 90 x 35	96.00
776.562	2025 x 95 x 30	135.00
776.469	2520 x 115 x 35	264.00

## Laser alignment tool

With this alignment tool you can precisely, quickly and easily project vertical, horizontal and crossed laserlines. Within a range of  $\pm 4^\circ$  minor inclination errors are automatically compensated by means of the integrated spirit level, to level the projected horizontal line.

- Range: up to 30 m (dependent on the lighting conditions).
- Self-levelling range:  $4^\circ$ .
- Horizontal and vertical accuracy:  $\pm 0.3$  mm/m.
- Laser: 510 - 530 nm, class 2 conform to IEC 60825-1.
- Lock function for projecting at an angle and transport protection.
- On/off switch.
- Dimensions: 74x64x75 mm.
- Weight: 270 g.
- Protection: IP54.
- Delivered in a soft case.
- Power supply: 2 batteries type AA.



*Filetta*

**NEW**



Item No.	Description	Price EUR
910.369	Alignment tool	66.00
<b>Option:</b>		
495.111	Spare battery (2 needed)	0.60

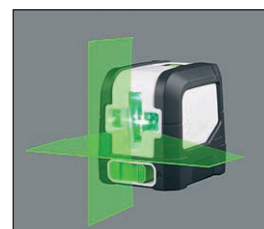
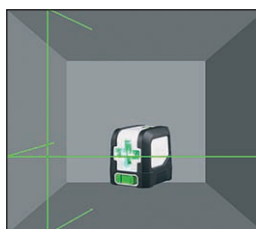

**NEW**

### Plastic cases for gauge blocks

Plastic cases with removeable foam inserts to store gauge blocks safely. Available in 3 sizes.



Item No.	Gauge blocks size/mm	Price EUR
906.998	0.50- 13.00	2.50
906.999	13.50- 50.00	2.80
908.808	60.00-100.00	5.60



### Wooden cases for gauge block sets

Wooden cases with cutouts and size indications for gauge block sets.



**NEW**

PRICE

Item No.	Price EUR	Size mm	Increment mm	Pieces
<b>M32:</b> 910.361	32.40	1.005	–	1
		1.01 - 1.09	0.01	9
		1.1 - 1.9	0.1	9
		1 - 9	1	9
		10 - 30	10	3
<b>M47:</b> 910.362	32.40	1.005	–	1
		1.01 - 1.09	0.01	9
		1.1 - 1.9	0.1	9
		1 - 24	1	24
		25 - 100	25	4
<b>M87:</b> 910.363	45.00	1.001 - 1.009	0.001	9
		1.01 - 1.49	0.01	49
		0.5 - 9.5	0.5	19
		10 - 100	10	10
<b>M88:</b> 910.364	45.00	1.0005	–	1
		1.001 - 1.009	0.001	9
		1.01 - 1.49	0.01	49
		0.5 - 9.5	0.5	19
<b>M103:</b> 910.365	51.00	1.005	–	1
		1.01 - 1.49	0.01	49
		0.5 - 24.5	0.5	49
		25 - 100	25	4
<b>M112:</b> 910.366	51.00	1.0005	–	1
		1.001 - 1.009	0.001	9
		1.01 - 1.49	0.01	49
		0.5 - 24.5	0.5	49
		25 - 100	25	4



**NEW**

## Pin gauges in sets

Hardened steel pin gauges in sets with favourable price-performance ratio, very well suited for workshop use. Delivery in plastic case with a declaration of conformity and holder for Go/NoGo determination.

- Hardened steel.
- Diameter range: 0.20 - 20.00 mm.
- Increment: 0.1 mm.
- Accuracy:  $\pm 0.003$  mm.
- Without handle.
- Pin gauges  $> \varnothing 1.5$  mm with size indication.
- Length: 50 mm.
- Delivered in a plastic carrying case with a declaration of conformity with pin gauges in separate plastic tubes with size indication.
- Delivered with holder with Go/NoGo indication.



*Filetta*



**NEW**

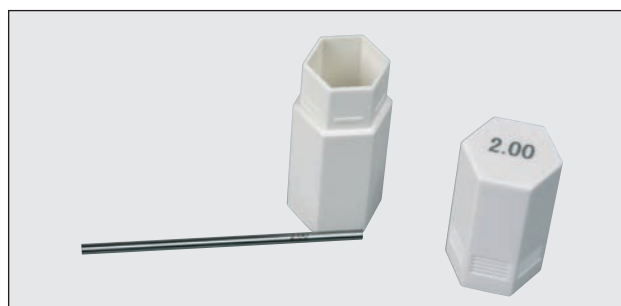

Item No.	Diameter mm	Increment mm	Number per set	Price EUR
910.367	0.20 - 10.00	0.1	99	194.00
910.368	10.00 - 20.00	0.1	101	335.00
<b>Holders for Go/NoGo determination:</b>				
910.378	0.20 - 1.50			16.30
910.379	1.20 - 6.50			20.20
910.380	5.00 - 14.00			25.10
910.381	12.00 - 16.50			30.00
910.382	14.00 - 19.50			35.40
910.383	18.00 - 22.00			39.80

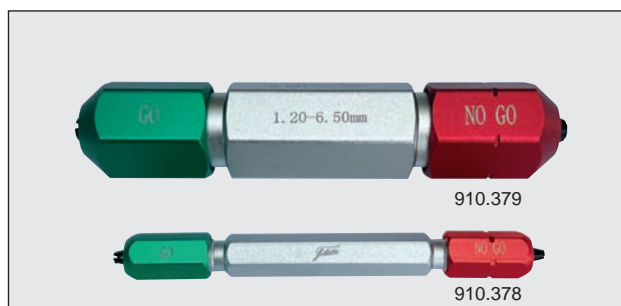



**NEW**

## Steel measuring balls

Steel measuring balls for measuring e.g. internal tapers.

- Material: chrome alloy steel.
- Hardness: 63 HRC.
- Nominal dimension tolerance: <math>< 2.5 \mu\text{m}</math>.
- Roundness: <math>< 0.6 \mu\text{m}</math>.
- Surface roughness: <math>< 0.05 \mu\text{m}</math>.
- Two balls of each size.
- Delivered with a declaration of conformity.
- Set 909.647: Delivered in a plastic case.

*Filetta*



909.647

**NEW**

Item No.	Size mm	Number per size	Price EUR
910.224	1	2	4.30
910.225	2	2	4.30
910.226	3	2	4.30
910.227	4	2	4.30
910.228	5	2	5.30
910.229	6	2	5.30
910.230	7	2	5.30
910.231	8	2	5.30
910.232	9	2	5.30
910.233	10	2	6.00
910.234	11	2	6.00
910.235	12	2	6.40
910.237	13	2	6.40
910.238	14	2	6.70
910.239	15	2	6.70
910.240	16	2	7.30
910.241	17	2	7.30
910.242	18	2	7.30
910.243	19	2	8.40
910.244	20	2	9.50
910.245	21	2	9.50
910.246	22	2	10.60
910.247	23	2	10.60
910.248	24	2	11.70
910.249	25	2	11.70

### Set steel measuring balls

Item No.	Size mm	Incr. mm	Number per size	Total number	Price EUR
909.647	1 - 25	1	2	50	136.00

PRICE



**NEW**

## Plug gauges

Manufactured according DIN 7162 and 7164. Available from 1 to 100 mm; up to 50 mm with Go and NoGo on one handle, over 50 mm in two parts.

- DIN 7162 and 7164.
- H7 fit size in hardened steel.
- Available from 1 to 100 mm; up to 50 mm with Go and NoGo on one handle, over 50 mm in two parts.
- With serial number.
- Delivered with a manufacturer measuring report.
- Individual plug gauges delivered in a plastic tube. Set delivered in a plastic case.
- Including wear allowance at the Go end.

### Wear allowance

New gauges are supplemented with a wear allowance on the Go end: z (plus) for plug gauges. Accordingly, the size indicated on the handle is not similar to the measured value of the new Go end.



**NEW**

**PRICE**

*Filetta*

Item No.	Size H7 mm	Price EUR	Item No.	Size H7 mm	Price EUR	Item No.	Size H7 mm	Price EUR
911.000	1	30.70	911.023	19	17.90	911.047	47	45.00
911.001	1.5	27.60	911.024	20	19.70	911.048	48	45.00
911.002	2	15.80	911.025	21	19.70	911.049	50	45.00
911.003	2.5	14.70	911.026	22	19.70	911.050	52	52.00
911.004	3	14.70	911.027	23	19.80	911.051	55	52.00
911.005	3.5	14.70	911.028	24	19.80	911.052	58	56.00
911.006	4	14.70	911.029	25	19.80	911.053	60	56.00
911.007	4.5	14.70	911.030	26	22.50	911.054	62	56.00
911.008	5	14.70	911.031	27	22.50	911.055	65	70.00
911.009	5.5	14.70	911.032	28	22.50	911.056	68	70.00
911.010	6	11.80	911.033	30	25.00	911.057	70	74.00
911.011	7	13.20	911.034	32	25.00	911.058	72	74.00
911.012	8	13.20	911.035	33	26.80	911.059	75	81.00
911.013	9	13.20	911.036	34	27.60	911.060	78	82.00
911.014	10	13.20	911.037	35	29.10	911.061	80	86.00
911.015	11	14.20	911.038	36	29.10	911.062	82	102.00
911.016	12	14.20	911.039	37	29.10	911.063	85	102.00
911.017	13	14.20	911.040	38	29.10	911.064	88	102.00
911.018	14	14.20	911.041	40	29.10	911.065	90	109.00
911.019	15	15.50	911.042	42	35.40	911.066	92	111.00
911.020	16	16.30	911.043	44	39.70	911.067	95	115.00
911.021	17	16.30	911.044	45	45.00	911.068	98	123.00
911.022	18	16.30	911.045	46	45.00	911.069	100	127.00

### Set plug gauges

Item No.	Description	Price EUR
911.157	Plug gauges (Go + NoGo) H7: 3, 4, 5, 6, 8, 10, 12 mm	100.00

**NEW**

## Plug gauges

Manufactured according DIN 7162. Available from 1 to 20 mm; with Go and NoGo on one handle.

- DIN 7162.
- G7 fit size in hardened steel.
- Available from 1 to 20 mm; with Go and NoGo on one handle.
- With serial number.
- Delivered in a plastic tube with a manufacturer measuring report.
- Including wear allowance at the Go end.

### Wear allowance

New gauges are supplemented with a wear allowance on the Go end: z (plus) for plug gauges. Accordingly, the size indicated on the handle is not similar to the measured value of the new Go end.



*Filetta*



Item No.	Size G7 mm	Price EUR
911.158	1	38.70
911.159	1.5	34.70
911.160	2	19.90
911.161	2.5	18.50
911.162	3	18.50
911.163	3.5	18.50
911.164	4	18.50
911.165	4.5	18.50
911.166	5	18.50
911.167	5.5	18.50
911.168	6	14.90
911.169	7	16.70
911.170	8	16.70
911.171	9	16.70
911.172	10	16.70
911.173	11	17.90
911.174	12	17.90
911.175	13	17.90
911.176	14	17.90
911.177	15	19.50
911.178	16	20.50
911.179	17	20.50
911.180	18	20.50
911.181	19	22.50
911.182	20	24.90



**NEW**



**NEW**

## Setting rings

Manufactured according DIN 2250 form C. Available from 3 to 200 mm.

- DIN 2250 form C.
- Material: hardened steel.
- The size is indicated on the setting rings to three decimal places.
- With serial number.
- Delivered with a manufacturer measuring report.
- Individual setting rings from 3 - 32 mm: delivered in a plastic case, individual setting rings from 33 - 200 mm: delivered in a cardboard case.



Item No.	Size mm	Price EUR	Item No.	Size mm	Price EUR	Item No.	Size mm	Price EUR
911.070	3	23.00	911.099	33	30.90	911.131	88	107.00
911.071	4	23.00	911.100	34	30.90	911.132	90	107.00
911.072	5	23.00	911.101	35	30.90	911.133	92	107.00
911.073	6	20.50	911.102	36	32.70	911.134	95	115.00
911.074	7	20.50	911.103	37	32.70	911.135	98	132.00
911.075	8	20.50	911.104	38	32.70	911.136	100	132.00
911.076	9	20.50	911.105	40	32.70	911.137	105	149.00
911.077	10	20.50	911.106	42	37.40	911.138	110	156.00
911.079	11	22.30	911.107	44	37.40	911.139	115	169.00
911.080	12	22.30	911.108	45	37.40	911.140	120	186.00
911.081	13	22.30	911.109	46	45.00	911.141	125	201.00
911.082	14	22.30	911.110	47	45.00	911.142	130	211.00
911.083	15	22.30	911.114	48	45.00	911.143	135	225.00
911.084	16	24.10	911.115	50	45.00	911.144	140	247.00
911.085	17	24.10	911.116	52	50.00	911.145	145	270.00
911.086	18	24.10	911.117	55	50.00	911.146	150	275.00
911.087	19	24.10	911.118	58	55.00	911.147	155	297.00
911.088	20	24.10	911.120	60	55.00	911.148	160	314.00
911.089	21	27.30	911.121	62	68.00	911.149	165	346.00
911.090	22	27.30	911.122	65	68.00	911.150	170	370.00
911.091	23	27.30	911.123	68	76.00	911.151	175	395.00
911.092	24	27.30	911.124	70	76.00	911.152	180	444.00
911.093	25	27.30	911.125	72	82.00	911.153	185	491.00
911.094	26	27.30	911.126	75	82.00	911.154	190	530.00
911.095	27	27.30	911.127	78	82.00	911.155	195	580.00
911.096	28	27.30	911.128	80	82.00	911.156	200	614.00
911.097	30	27.30	911.129	82	98.00			
911.098	32	30.90	911.130	85	98.00			

*Filetta*

**NEW**

## Adjustable snap gauges

Snap gauges with adjustable anvil. Especially suitable for Go/NoGo determination and batch measurements.

- Tungsten carbide measuring faces.
- Flatness of anvil: 1.5 µm.
- Parallelism between anvils: 0 - 32 mm: 3 µm / 32 - 89 mm: 4 µm / 89 - 152 mm: 5 µm.
- To set for example with gauge blocks.
- Conforms to factory standard.
- Delivered with a manufacturer measuring report.

**NEW***Filetta*

860.016



Item No.	Measuring range/mm	Price EUR
860.012	0- 6	37.40
860.013	6- 13	37.40
860.014	13- 19	39.90
860.015	19- 25	39.90
860.016	25- 32	50.00
860.017	32- 38	50.00
860.018	38- 44	55.00
860.019	44- 51	55.00
860.020	51- 57	60.00
860.021	57- 63	60.00
860.022	63- 70	65.00
860.023	70- 76	65.00
860.024	76- 82	67.00
860.025	82- 89	67.00
860.026	89- 95	72.00
860.027	95-101	72.00
860.028	101-108	82.00
860.029	108-114	82.00
860.030	114-120	95.00
860.031	120-127	95.00
860.032	127-133	105.00
860.033	133-139	105.00
860.034	139-146	127.00
860.035	146-152	127.00



**NEW**

## Robust Stand magnifier 5x with LED illumination

Robust stand magnifier with aluminum housing, LED illumination and a very large field of view.

- Field of view:  $\varnothing$  85 mm.
- Lens diameter:  $\varnothing$  70 mm.
- Illumination: 3 LEDs with 3 luminous intensity settings.
- Aluminum housing.
- Dimensions:  $\varnothing$  94 x 52 mm.
- Weight: 194 g.
- Delivery in a soft case with a micro fiber cleaning cloth and micro USB cable.
- Power supply: rechargeable battery with micro USB cable.

*Filetta*



**NEW**



Item No.	Magnification	Price EUR
910.254	5x	33.00

## Scale magnifier 10x with LED illumination

All-purpose scale magnifier with LED illumination and a large field of view.

- Field of view:  $\varnothing$  30 mm.
- Measuring range standard scale: 30 mm.
- Graduation: 0.1 mm.
- Illumination: 8 LEDs.
- Dimensions:  $\varnothing$  45 x 51 mm.
- Weight: 106 g.
- For optional scales: see "Peak scales  $\varnothing$  35 mm".
- Power supply: 4 batteries (V394).



*Filetta*

**NEW**



Item No.	Description	Price EUR
910.319	Magnifier with standard scale in a case (for scales of $\varnothing$ 35 mm)	44.00
<b>Option:</b>		
420.248	Spare battery (4 needed)	1.30

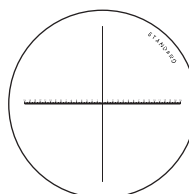

**NEW**

## Magnifying glass 2 - 20x with LED illumination

Handy magnifying glass with LED illumination. This magnifying glass has two lenses. One big lens and a small lens in the handle.

- Magnification: 2x (108x63 mm) and 20x (ø 21 mm).
- Illumination: 2 COB-LED strips (big lens) and 1 LED (small lens).
- Two luminous intensity settings.
- Dimensions: 136x96 mm, handle 115 mm.
- Weight (without batteries): 206 g.
- Delivery with a micro fiber cleaning cloth.
- Power supply: 3 batteries 1.5 V (AAA).

**NEW**

Item No.	Description	Price EUR
910.317	Magnifying glass 2-20x	8.30
<b>Option:</b>		
497.914	Spare battery (3 needed)	0.70



## Magnifying glass 2 - 6x with LED and UV illumination

Handy magnifying glass with LED and UV illumination. This model of the classic magnifying glass has a lens-in-lens construction. In the big lens a smaller lens has been integrated which offers extra strong magnification.

- Magnification: 2x (ø 85 mm) and 6x (ø 21 mm).
- Illumination: switch between 3 LEDs and 1 UV LED.
- Weight (without batteries): 116 g.
- Dimensions: ø 99 x 230 mm.
- Power supply: 3 batteries 1.5 V (AA).

*Filetta*

Item No.	Description	Price EUR
910.318	Magnifying glass 2-6x	4.90
<b>Option:</b>		
495.111	Spare battery (3 needed)	0.60

**NEW**



**NEW**

## Precision scale magnifiers 6x ... 12x

Precision scale magnifiers with parallax-free reading and black anodized aluminum open housing. The eyepiece can be removed to be used as a stand-alone magnifier.

- Precision aplanatic glass lenses.
- Adjustable for individual focus.
- Removable eyepiece.
- Scale accuracy  $\pm (0.01 + L/1000)$  mm.
- Delivered in a plastic tube.

**NEW**



903.201

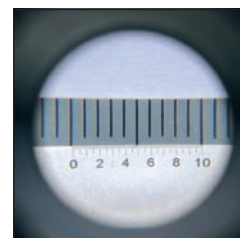

Item No.	Magnification	Scale length mm	Graduation mm	Graduation thickness/mm	Price EUR
903.200	6x	20	0.1	0.02	90.00
903.201	8x	10	0.1	0.02	84.00
903.202	10x	10	0.1	0.02	88.00
903.203	12x	6	0.05	0.01	101.00
<b>Options:</b>					
498.823	Battery (3 needed)				1.30
903.204	LED illumination				44.00



903.204

## Scales with guided magnifying glass

Stainless steel scales of up to 400 mm for precise measurement on different surfaces. Delivered with one black anodized aluminum 10x magnifier with parallax-free reading. An optional second sliding magnifier can be added to the scale. The optional LED illumination can be used on these magnifiers as well.

- Measuring range: 0 - 400 mm.
- Graduation: 0.1 mm.
- Graduation thickness: 0.02 mm.
- Accuracy:  $\pm 0.02$  mm.
- Delivered in a plastic case.

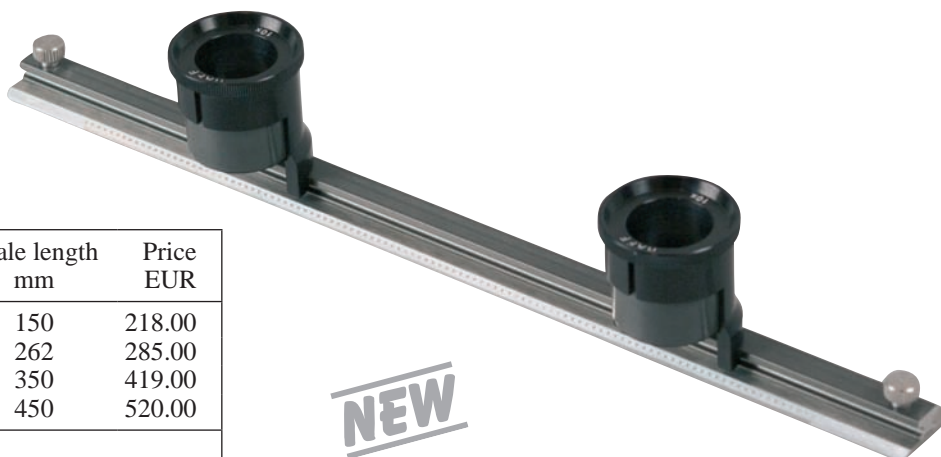

**NEW**

Item No.	Measuring range/mm	Scale length mm	Price EUR
903.205	100	150	218.00
903.206	212	262	285.00
903.207	300	350	419.00
903.208	400	450	520.00
<b>Options:</b>			
903.209	Second magnifier with slider		59.00
903.204	LED illumination		44.00

903.205 + 903.209



**NEW**

**Glass rulers L = 50 ... 300 mm**

Very accurate glass rulers, made from clear glass with a 0.1 or 0.5 mm graduation. Ideal for checking the magnification accuracy of profile projectors and microscopes, as well as the table feed accuracy of measuring equipment.

- Graduation: 0.1 or 0.5 mm.
- Accuracy:  $(1.5 + 2L/1000) \mu\text{m}$ ;  
L = measuring length in mm.
- Material: sodium glass.
- Expansion coefficient:  $8.6 \cdot 10^{-6}/^{\circ}\text{C}$ .
- Thickness: 5 mm.
- Width: 30 mm.
- With serial number.
- Delivered in an aluminum carrying case with a manufacturer measuring report.



*Filetta*

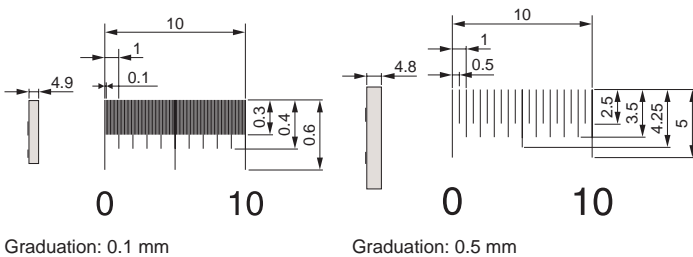

**NEW**

**PRICE**

Item No.	Measuring range/mm	Graduation mm	Line thickness graduation/mm	Total length mm	Weight g	Price EUR
910.321	0- 50	0.1	0.01	80	29	200.00
910.322	0- 50	0.5	0.1	80	29	200.00
910.255	0-100	0.1	0.01	130	47	267.00
910.521	0-100	0.5	0.1	130	47	267.00
910.256	0-200	0.1	0.01	230	83	381.00
910.522	0-200	0.5	0.1	230	83	381.00
910.257	0-300	0.1	0.01	330	119	576.00
910.523	0-300	0.5	0.1	330	119	576.00
<b>Option:</b>						
905.114	Hand magnifier M = 15x					18.00



905.114



**NEW**

## Aluminum rulers

- Measuring range: 0 - 1000 mm.
- Graduation: 1 mm.
- Material: anodized aluminum.
- Zero coincides with left end.
- With hanger hole.

**NEW**

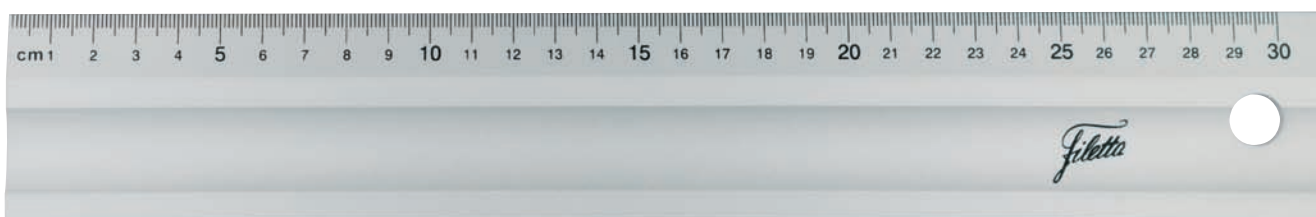

906.615

*Filetta*

**PRICE**

Item No.	Dimensions l x w x t/mm	Price EUR
906.615	300 x 50 x 5	4.20
906.616	600 x 50 x 5	6.20
906.617	1000 x 50 x 5	9.50

## Stainless steel rulers

- Measuring range: 0 - 1000 mm.
- Graduation: 1 mm on the front side on the upper and lower edges, 0.5 mm on the back side on the upper and lower edges.
- Matt chrome-plated stainless steel surface.
- EC class II.
- Etched graduation.

*Filetta*

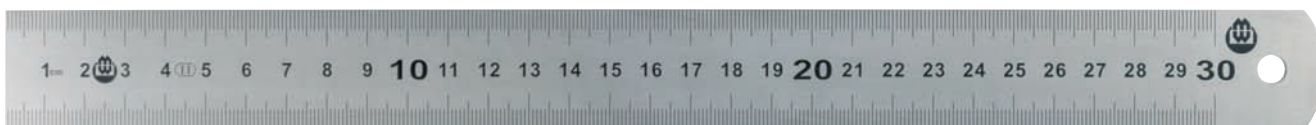

910.323

**NEW**

**PRICE**

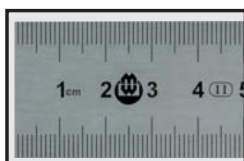
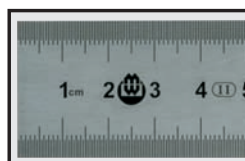

Item No.	Dimensions l x w x t/mm	Price EUR
910.323	300 x 30 x 1	4.30
910.324	500 x 30 x 1	5.20
910.325	1000 x 30 x 1	11.50

**NEW**

### Circumference tapes

- Separate graduations for circumference and diameter in mm.
- Vernier: 0.1 mm.
- Tape width: 13 mm.
- Stainless steel with yellow plastic coating for easy reading.
- Accuracy according EC class II.

**NEW**



841.468

Item No.	Diameter mm	Circumference mm	Price EUR
841.468	20- 300	60- 950	86.00
841.469	20- 1200	60- 3780	121.00
841.470	20- 2400	60- 7540	160.00
841.471	20- 3600	60- 11310	239.00

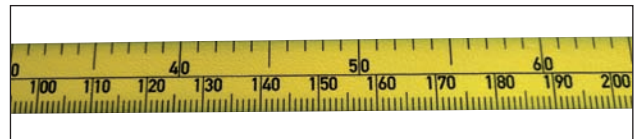

### Digital spring scale

- Measuring range: 0 - 50 kg.
- Resolution:
  - 0.005 kg (measuring range 0 - 10 kg),
  - 0.01 kg (measuring range 10 - 50 kg).
- Kg/lbs conversion.
- Illuminated LCD display.
- Automatic switch-off.
- Reset.
- Automatic hold function.
- Dimensions: 110x65x30 mm.
- Weight: 170 g.
- Power supply: 2 batteries type AAA.

**NEW**



**PRICE**

Item No.	Measuring range/kg	Price EUR
910.359	0 - 50	27.00
<b>Option:</b> 497.914	Spare battery (2 needed)	0.70

*Filetta*



**NEW**

## DiMag converter

The DiMag is an interface for direct data collection from measuring instruments with a Digimatic data output, for example Mitutoyo. The USB connection provides a RS232C interface (according Magnescale U-series dial indicators). Data can also be requested through the built-in data button or foot switch. The interface is powered from the data connection, the USB version emulates a COM port.

**NEW**



348.052

Item No.	Type/description	Price EUR
348.052	DiMag converter USB	139.00
348.058	DiMag converter RS232C	139.00
<b>Options:</b>		
348.186	D/RS foot switch Economic	44.00
348.190	D/RS foot switch Herga	73.00
348.189	D/RS foot switch Industrial	105.00



**ZIBTRPRO**  
tehnologija obdelave · vpenjalni sistemi