

# DOMX<sup>®</sup>

The revolution on HRSA Turning



DOMX

NEW

PHH  
NEW  
GRADE

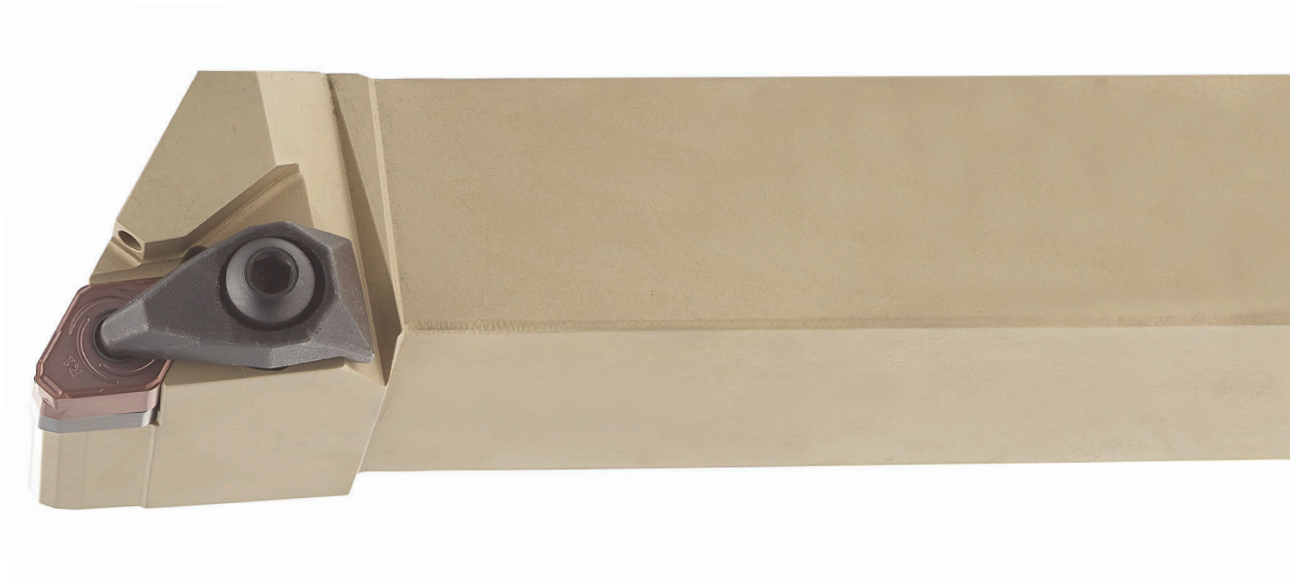

# DOMX<sup>®</sup>

SINCE 1916

# DOMX - THE REVOLUTION IN HRSA MEDIUM TO ROUGH TURNING

NEW

A revolução em torneamento de materiais termorresistentes | La revolución en el torneado de materiales exóticos

Designed especially for HRSA, the new DOMX combined with the latest PHH technology, offers exceptional performance in exotic materials machining. When your material has high Ni or Co content DOMX is the choice!

- 🔗 First choice for **HRSA** medium to rough turning;
- 🔗 **4 positive cutting edges on double sided insert.**

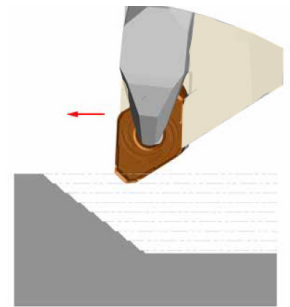

- 🔗 Machine at 45° with a 93° holder;
- 🔗 **Up to +140% tool life improvement.**

## PHH GRADE | Grau PHH | Grado PHH

Product of the latest coating technology, the new PHH coating comes to revolutionize the turning of HRSA. PHH is a stable PVD coating that merges both high hardness and unmatched heat resistance.



First choice for HRSA.



Solution for general turning of HRSA.



	1	5	10	15	20	25	30	
<b>S</b> HEAT RESISTANT / TITANIUM ALLOYS			PHH910	PHH910	PHH910	PHH910	PHH910	PVD
				PHH920	PHH920	PHH920	PHH920	PVD



Inserts Pastilhas Plaquetas	(1) Geometry code	ISO Reference	S		Dimensions (mm) Dimensões (mm) Dimensiones (mm)				Cutting Conditions Condições de Corte Condiciones de Corte					Technical drawing Desenho técnico Dibujo técnico	
			PVD		D	S	Re	d1	ap (mm)	Min	Max	fn (mm/rev)	Min		Max
			(2) Grade code	X6											
	1124595	DOMX 1506R1-GS	PHH910	PHH920	12,70	6,35	0,80	5,16	1,50	0,20	2,00	0,30	0,20	0,50	
	1124493	DOMX 1506L1-GS	PHH910	PHH920	12,70	6,35	0,80	5,16	1,50	0,20	2,00	0,30	0,20	0,50	

⊗ First choice | 1ª Escolha | 1ª Opción   ⊗ Stock Items | Itens de stock   ○ Available under request | Disponível sob consulta | Disponible bajo consulta

Insert Order Code: (1) Geometry code + (2) Grade code

## A = DDJN-DX1 45° | TOOLHOLDERS

### (D) DIMPLE LOCK TOOLHOLDERS

Roughing to Heavy Roughing	Roughing to Heavy Roughing
DOMX (L1)	DOMX (R1)
	
(15)	(15)

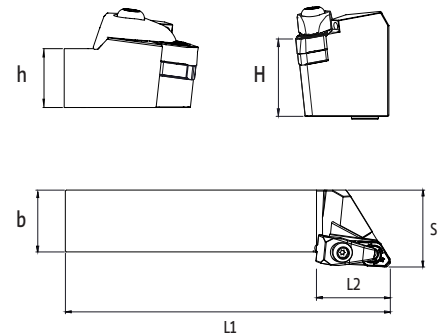



Order Code		Reference	Dimensions (mm)					Insert	Kg	Stock	
R	L		H=h	b	L1	L2	S			R	L
182000900	182001200	DDJN R/L 2020 K15-A-DX1	20	20	125	42	25	DOMX 1506..	0,40	⊗	⊗
182001000	182001300	DDJN R/L 2525 M15-A-DX1	25	25	150	42	32	DOMX 1506..	0,75	⊗	⊗
182001100	182001400	DDJN R/L 3232 P15-A-DX1	32	32	170	42	40	DOMX 1506..	1,30	⊗	⊗

⊗ Stock item | Produto de stock | Itens de stock

○ Available under request | Disponível sobre consulta  
Disponível bajo consulta







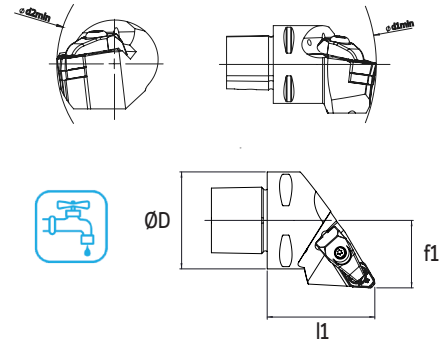
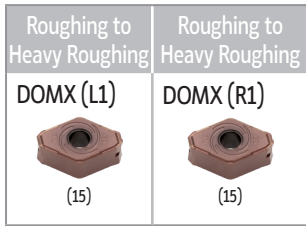

Insert order code = (1) Geometry Code + (2) Grade Code

## SPARE PARTS | Complementos | Repuestos

Cutter Reference	Shim R	Shim L	Spring	Clamp	Clamp Screw	Wrench	Screw 1	Screw 2	Screw Allen
DDJN R/L 2020 K15-A-DX1									
DDJN R/L 2020 K15-A-DX1	CD150503	CD150502	M09513	GA07002	D0602900	SS40	H0600475	H1000875	T1000875
DDJN R/L 2525 M15-A-DX1	CD150503	CD150502	M09513	GA07002	D0602900	SS40	H0600475	H1000875	T1000875
DDJN R/L 3232 P15-A-DX1	CD150503	CD150502	M09513	GA07002	D0602900	SS40	-	H1000875	-

## (D) DIMPLE LOCK TOOLHOLDERS









Order Code		Reference	Dimensions (mm)					Insert	Kg	Stock	
R	L		ØD	Ød1 min	Ød2 min	f1	l1			R	L
182000100	182000500	PSC40-DDJNR/L27055-15-DX1	40	110	145	27	55	DOMX 1506..	0,42		
182000200	182000600	PSC50-DDJNR/L35060-15-DX1	50	110	165	35	60	DOMX 1506..	0,80		
182000300	182000700	PSC63-DDJNR/L45065-15-DX1	63	110	190	45	65	DOMX 1506..	1,10		
182000400	182000800	PSC80-DDJNR/L55080-15-DX1	80	110	250	55	80	DOMX 1506..	2,74		

 Stock item | Produto de stock | Itens de stock

 Available under request | Disponível sobre consulta  
Disponível bajo consulta

Insert order code = (1) Geometry Code + (2) Grade Code

## SPARE PARTS || Complementos | Repuestos

Cutter Reference	Shim R	Shim L	Shim Screw	Spring	Clamp	Clamp Screw	Wrench
PSC40-DDJNR/L27055-15-DX1							
PSC50-DDJNR/L35060-15-DX1	CD150503	CD150502	T06010000	M09513	GA07002	D0602900	SS40
PSC63-DDJNR/L45065-15-DX1	CD150503	CD150502	T06010000	M09513	GA07002	D0602900	SS40
PSC80-DDJNR/L55080-15-DX1	CD150503	CD150502	T06010000	M09513	GA07002	D0602900	SS40

Note: It is possible to adapt your standard toolholder | É possível adaptar um suporte convencional | Puede adaptar un soporte convencio-

### HEADQUARTERS

PALBIT. S.A.

P.O.Box 4 - Palhal

3854-908 - Branca ALB - Portugal

T (+351) 234 540 300 | F (+351) 234 540 301

palbit@palbit.pt | www.palbit.pt

