

# *P92-2 and P92-90* *Face grooving tools*

*for the range  $\emptyset$  25 mm -  $\infty$  mm*

- ▶ *Cartridge-system*
- ▶ *Monoblock-system*
- ▶ *P92 2 TMS Blade*

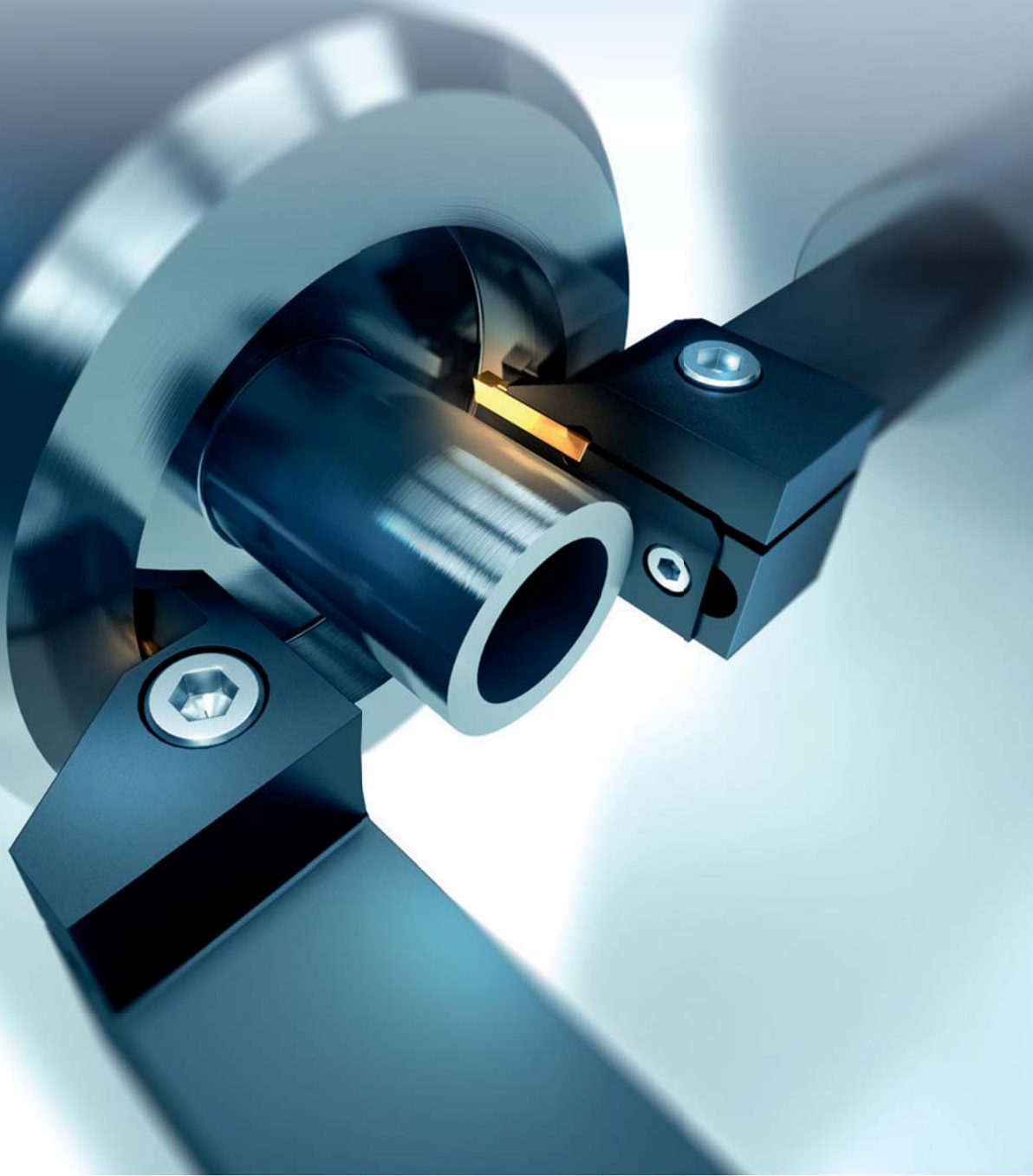
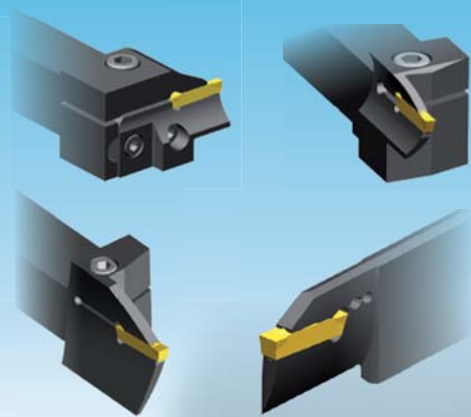

# P92-2 and P92-90 Face grooving tools

## Modular Cartridge System

Turning to the center or to the outside diameter is possible provided the 1st cut has been positioned inside the range  $\varnothing$  min -  $\varnothing$  max.

**Face grooving:** Cartridge choice

Each cartridge is designed for a certain diameter range. This range is marked as  $\varnothing$  min -  $\varnothing$  max.

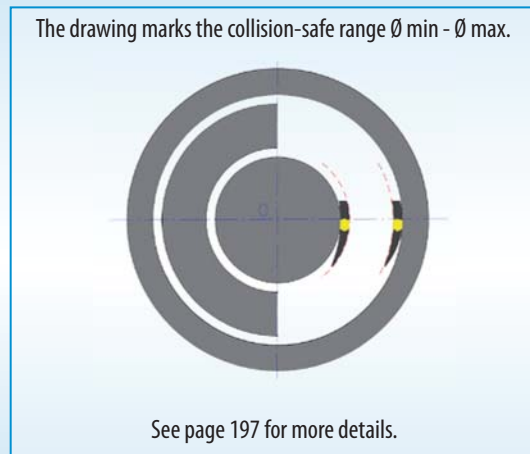
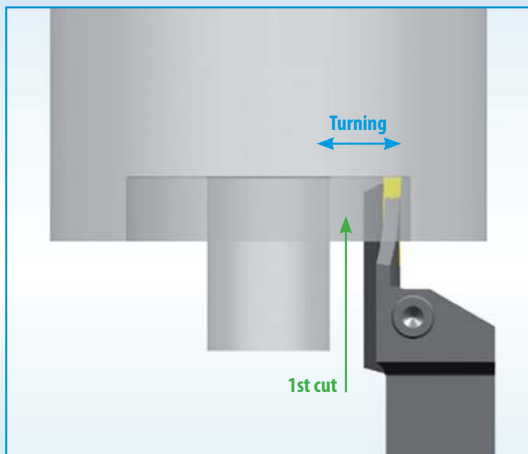

### Damage caused when the 1st cut has been positioned incorrectly.

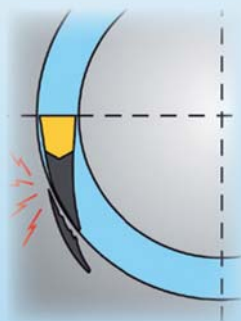

Shows the damage caused when the 1st cut is positioned within a smaller dimension than  $\varnothing$  min. **The outer face** of the cartridge collides with the component.

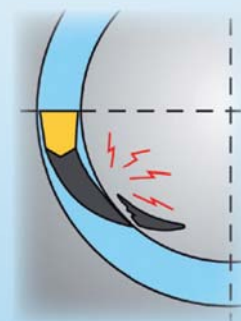

Shows the damage caused when the 1st cut is positioned outside  $\varnothing$  max, to the outer diameter. **The inner face** of the cartridge collides with the component.

# P92-2 and P92-90 Face grooving tools

## MONOBLOCK face grooving

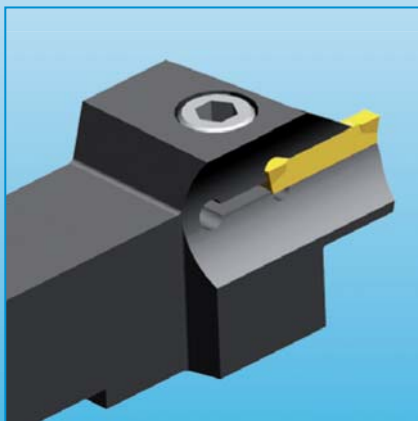
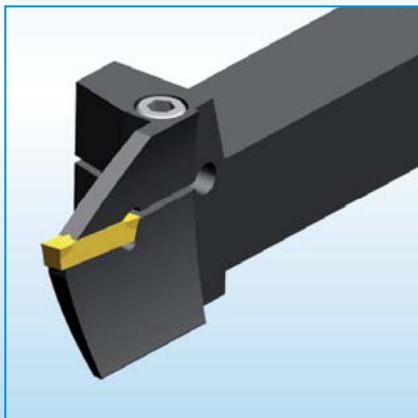
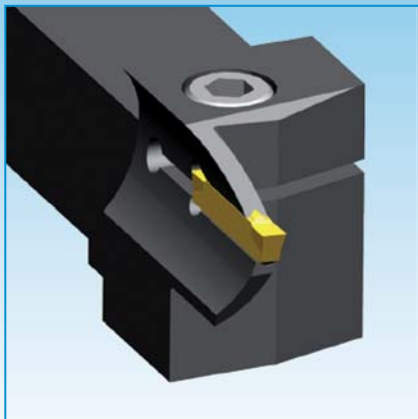

### Characteristics

- ✓ The strong and rigid tool holder construction, provides for vibration free run and grants production reliability.
- ✓ All GripLock P92 inserts fit in the MONOBLOCK face grooving tool holders.
- ✓ In case of problems you can just select the most effective chip breaker from the assortment of applicable inserts.
- ✓ 40 right hand and 40 left hand different tool holders with shank dimensions 20 mm x 20 mm and 25 mm x 25 mm.

### Technical specifications

#### Available width of inserts:

3 mm, 4 mm and 5 mm

#### Range of diameters:

25 mm - 450 mm

#### Depth of cut:

15 mm - 45 mm

#### Available chip breaker:

16



BTNG p. 46



BTNX p. 46



MTNS p. 47

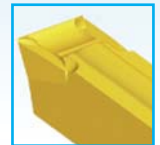

CTDS p. 47



MTNZ p. 48

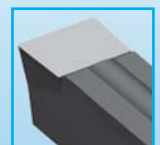

OTXS p. 49



STNZ p. 49

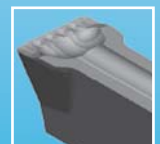

GTNS p. 50

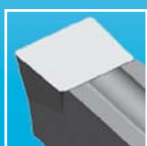

OTX p. 180



CTD/R/L p. 56



CTD/R/L-ALU p. 56



BTNN p. 53 + 55



RTNX p. 52



RTNG p. 52

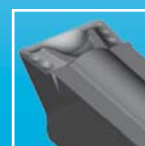

XTNS p. 51



VTNS p. 50

**Designation Code for face grooving cartridges**

**C92 LD 25 30 30**

Tool family	Cutting width S = 3 mm
CW Rotation	Ø max (30 mm) biggest safe diameter
Ø min (25 mm) smallest safe diameter	

**Designation Code for face grooving holders**

**P92 2 CXCRD 2020 K 30**

Tool family	Cutting width S = 3 mm
Face grooving	ISO tool length
Face grooving tool CW / CCW for cartridges	Shank dimensions

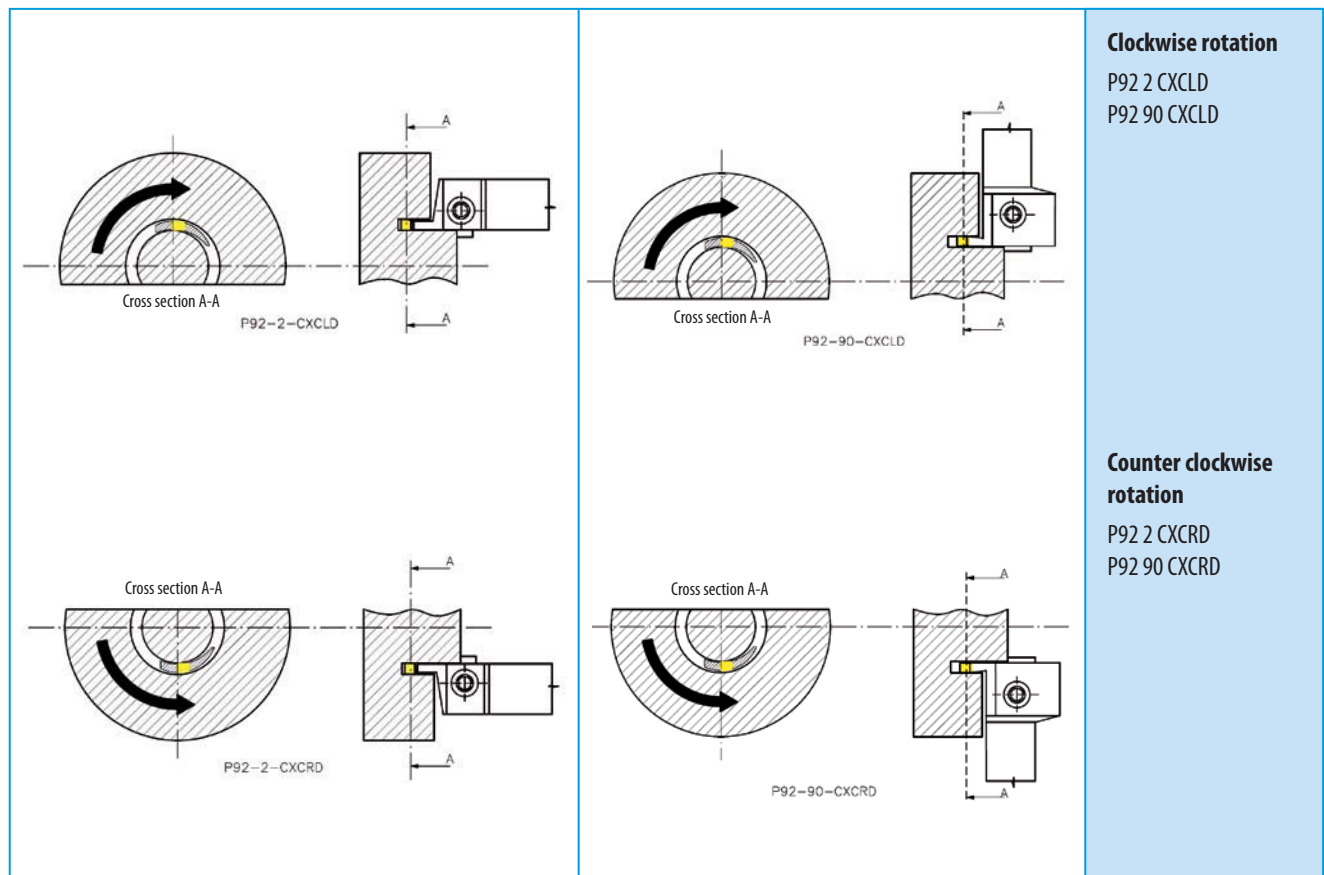

Tool holders with cartridges for face grooving



**P92 2 CXCLD**  
System P92-2

LH holder

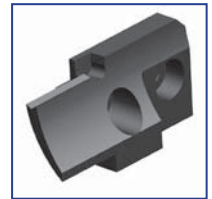
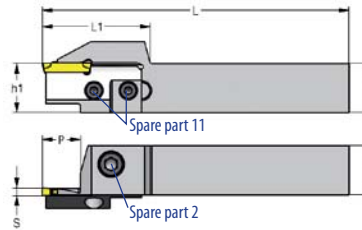

LH Cartridge

WG385 CARTRIDGE-HOLDER Ref.	ID-Nr.	( )	h	h1	b	P	L	L1	
P92 2 CXCLD 2020 K 30	10119	L	20	20	20	15	125	44	11+2
P92 2 CXCLD 2525 M 30	10121	L	25	25	25	15	150	44	11+2

WG385 CARTRIDGE Ref.	ID-Nr.	S	Ø min	Ø max
C92 LD 2530 30	10371	3	25	30
C92 LD 3035 30	10372	3	30	35
C92 LD 3542 30	10373	3	35	42
C92 LD 4250 30	10374	3	42	50
C92 LD 5058 30	10376	3	50	58
C92 LD 5866 30	10378	3	58	66
C92 LD 6675 30	10379	3	66	75
C92 LD 75100 30	10381	3	75	100
C92 LD 100200 30	10369	3	100	200
C92 LD 200300 30	43835	3	200	300

WG385 CARTRIDGE-HOLDER Ref.	ID-Nr.	( )	h	h1	b	P	L	L1	
P92 2 CXCLD 2020 K 40	10120	L	20	20	20	15	125	44	11+2
P92 2 CXCLD 2525 M 40	10122	L	25	25	25	15	150	44	11+2

WG385 CARTRIDGE Ref.	ID-Nr.	S	Ø min	Ø max
C92 LD 4254 40	10375	4	42	54
C92 LD 5466 40	10377	4	54	66
C92 LD 6680 40	10380	4	66	80
C92 LD 80100 40	10382	4	80	100
C92 LD 100200 40	10370	4	100	200
C92 LD 200300 40	37200	4	200	300

**Remark**

Holder and cartridges fit together provided the final two figures of the Reference-Nr. are identical.

Cartridges and inserts with the same "S" dimension fit together.

**Example:**

P92 2 CXCLD 2020 K **30** and C92 LD 3035 **30**  
P92 2 CXCLD 2525 M **40** and C92 LD 6680 **40**

**Fitting inserts**



p. 46



p. 52

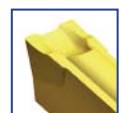

p. 53

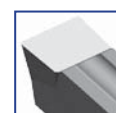

p. 180



Torque  
p.205-206,216

**Tool holders with cartridges for face grooving**

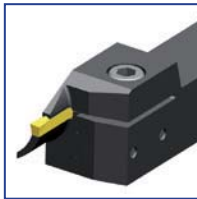

**P92 2 CXCRD**  
System P92-2

RH holder

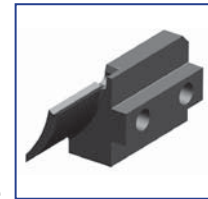
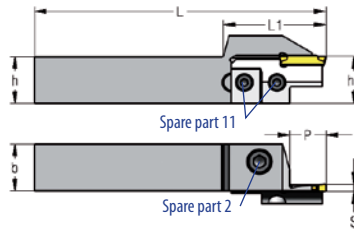

RH Cartridge

WG385 CARTRIDGE-HOLDER Ref.	ID-Nr.	( )	h	h1	b	P	L	L1	
P92 2 CXCRD 2020 K 30	10123	R	20	20	20	15	125	44	11+2
P92 2 CXCRD 2525 M 30	10125	R	25	25	25	15	150	44	11+2

WG385 CARTRIDGE Ref.	ID-Nr.	S	Ø min	Ø max
C92 RD 2530 30	10385	3	25	30
C92 RD 3035 30	10386	3	30	35
C92 RD 3542 30	10387	3	35	42
C92 RD 4250 30	10388	3	42	50
C92 RD 5058 30	10390	3	50	58
C92 RD 5866 30	10392	3	58	66
C92 RD 6675 30	10393	3	66	75
C92 RD 75100 30	10395	3	75	100
C92 RD 100200 30	10383	3	100	200
C92 RD 200300 30	18356	3	200	300

WG385 CARTRIDGE-HOLDER Ref.	ID-Nr.	( )	h	h1	b	P	L	L1	
P92 2 CXCRD 2020 K 40	10124	R	20	20	20	15	125	44	11+2
P92 2 CXCRD 2525 M 40	10126	R	25	25	25	15	150	44	11+2

WG385 CARTRIDGE Ref.	ID-Nr.	S	Ø min	Ø max
C92 RD 4254 40	10389	4	42	54
C92 RD 5466 40	10391	4	54	66
C92 RD 6680 40	10394	4	66	80
C92 RD 80100 40	10396	4	80	100
C92 RD 100200 40	10384	4	100	200
C92 RD 200300 40	21371	4	200	300

**Remark**

Holder and cartridges fit together provided the final two figures of the Reference-Nr. are identical.

**Example:**

P92 2 CXCRD 2020 K **30** and C92 RD 3035 **30**  
P92 2 CXCRD 2525 M **40** and C92 RD 6680 **40**

**Fitting inserts**



p. 46



p. 52

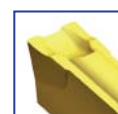

p. 53

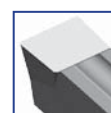

p. 180



p.205-206,216

Cartridges and inserts with the same "S" dimension fit together.

**Tool holders with cartridges for face grooving**

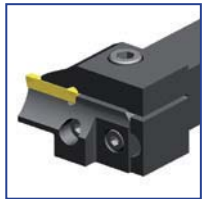

**P92 90 CXCLD**  
System P92-90

LH holder

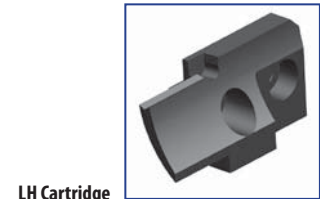
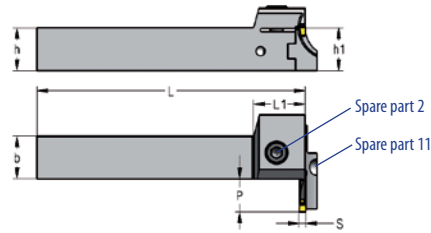

LH Cartridge

WG385 CARTRIDGE-HOLDER Ref.	ID-Nr.	(C)	h	h1	b	P	L	L1	
P92 90 CXCLD 2020 K 30	10127	L	20	20	20	15	125	24	11+2
P92 90 CXCLD 2525 M 30	10129	L	25	25	25	15	150	24	11+2

WG385 CARTRIDGE Ref.	ID-Nr.	S	Ø min	Ø max
C92 LD 2530 30	10371	3	25	30
C92 LD 3035 30	10372	3	30	35
C92 LD 3542 30	10373	3	35	42
C92 LD 4250 30	10374	3	42	50
C92 LD 5058 30	10376	3	50	58
C92 LD 5866 30	10378	3	58	66
C92 LD 6675 30	10379	3	66	75
C92 LD 75100 30	10381	3	75	100
C92 LD 100200 30	10369	3	100	200
C92 LD 200300 30	43835	3	200	300

WG385 CARTRIDGE-HOLDER Ref.	ID-Nr.	(C)	h	h1	b	P	L	L1	
P92 90 CXCLD 2020 K 40	10128	L	20	20	20	15	125	24	11+2
P92 90 CXCLD 2525 M 40	10130	L	25	25	25	15	150	24	11+2

WG385 CARTRIDGE Ref.	ID-Nr.	S	Ø min	Ø max
C92 LD 4254 40	10375	4	42	54
C92 LD 5466 40	10377	4	54	66
C92 LD 6680 40	10380	4	66	80
C92 LD 80100 40	10382	4	80	100
C92 LD 100200 40	10370	4	100	200
C92 LD 200300 40	37200	4	200	300

**Remark**

Holder and cartridges fit together provided the final two figures of the Reference-Nr. are identical.

**Example:**

P92 90 CXCLD 2020 K **30** and C92 LD 3035 **30**  
P92 90 CXCLD 2525 M **40** and C92 LD 6680 **40**

Cartridges and inserts with the same "S" dimension fit together.

**Fitting inserts**



p. 46

p. 52

p. 53



p. 180

p.205-206,216

**Tool holders with cartridges for face grooving**



**P92 90 CXCRD**  
System P92-90

RH holder

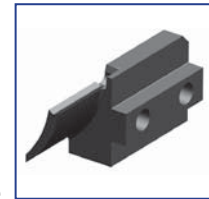
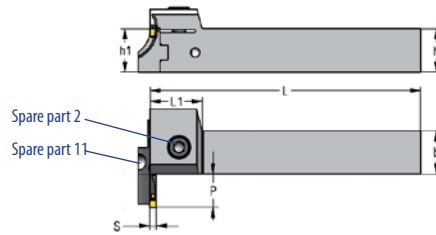

RH Cartridge

WG385 CARTRIDGE-HOLDER Ref.	ID-Nr.	( )	h	h1	b	P	L	L1	
P92 90 CXCRD 2020 K 30	10131	R	20	20	20	15	125	24	11+2
P92 90 CXCRD 2525 M 30	10133	R	25	25	25	15	150	24	11+2

WG385 CARTRIDGE Ref.	ID-Nr.	S	Ø min	Ø max
C92 RD 2530 30	10385	3	25	30
C92 RD 3035 30	10386	3	30	35
C92 RD 3542 30	10387	3	35	42
C92 RD 4250 30	10388	3	42	50
C92 RD 5058 30	10390	3	50	58
C92 RD 5866 30	10392	3	58	66
C92 RD 6675 30	10393	3	66	75
C92 RD 75100 30	10395	3	75	100
C92 RD 100200 30	10383	3	100	200
C92 RD 200300 30	18356	3	200	300

WG385 CARTRIDGE-HOLDER Ref.	ID-Nr.	( )	h	h1	b	P	L	L1	
P92 90 CXCRD 2020 K 40	10132	R	20	20	20	15	125	24	11+2
P92 90 CXCRD 2525 M 40	10134	R	25	25	25	15	150	24	11+2

WG385 CARTRIDGE Ref.	ID-Nr.	S	Ø min	Ø max
C92 RD 4254 40	10389	4	42	54
C92 RD 5466 40	10391	4	54	66
C92 RD 6680 40	10394	4	66	80
C92 RD 80100 40	10396	4	80	100
C92 RD 100200 40	10384	4	100	200
C92 RD 200300 40	21371	4	200	300

**Remark**

Holder and cartridges fit together provided the final two figures of the Reference-Nr. are identical.

Cartridges and inserts with the same "S" dimension fit together.

**Example:**

P92 90 CXCRD 2020 K **30** and C92 RD 3035 **30**  
P92 90 CXCRD 2525 M **40** and C92 RD 6680 **40**

**Fitting inserts**



p. 46



p. 52

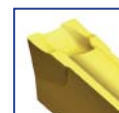

p. 53

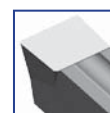

p. 180



p.205-206,216



**Designation Code for MONOBLOCK face grooving tools**

**P92 2 CXC B R 2020 K 30 30 A**

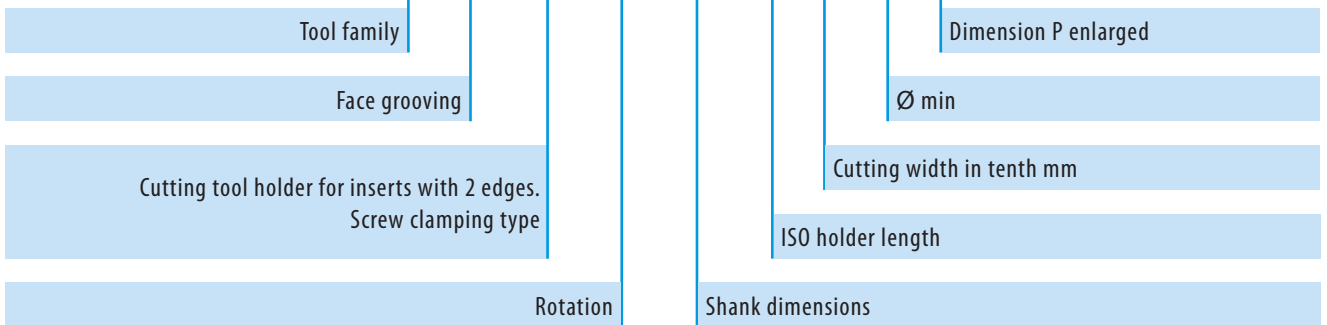

5

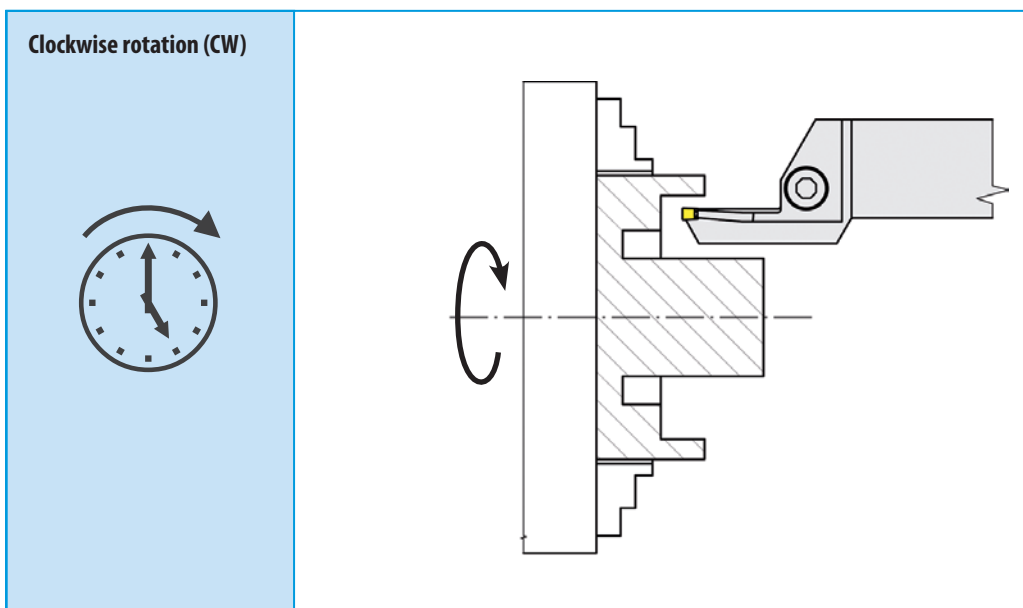
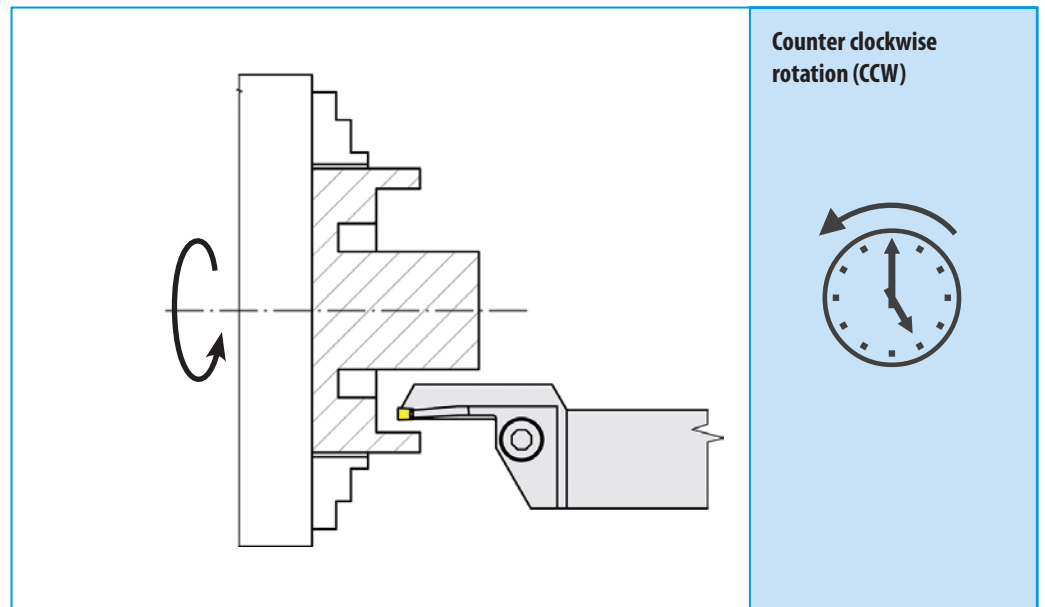

**MONOBLOCK Face grooving tool holders for cutting width 3 mm**



**P92 2 CXCBL**  
System P92-2

LH holder

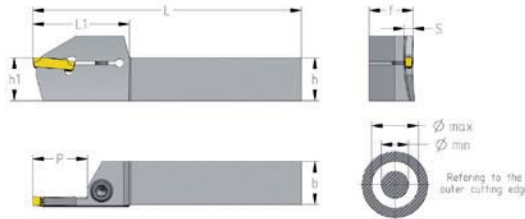

**P92 2 CXCBR**  
System P92-2

RH holder

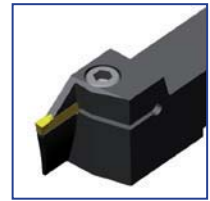

WG388 Ref.	ID-Nr.	(L)	Ø min	Ø max	h	h1	b	f	P	S	L	L1	
P92 2 CXCBL 2020 K 30 25	30164	L	25	30	20	20	20	20,5	15	3	125	35	2
P92 2 CXCBL 2020 K 30 30	30167	L	30	38	20	20	20	20,5	15	3	125	35	2
P92 2 CXCBL 2020 K 30 38	30169	L	38	48	20	20	20	20,5	15	3	125	35	2
P92 2 CXCBL 2020 K 30 48	30170	L	48	60	20	20	20	20,5	15	3	125	35	2
P92 2 CXCBL 2020 K 30 60	30171	L	60	75	20	20	20	20,5	22	3	125	43	2
P92 2 CXCBL 2020 K 30 75	30172	L	75	100	20	20	20	20,5	25	3	125	45	2
P92 2 CXCBL 2020 K 30 100	30173	L	100	200	20	20	20	20,5	25	3	125	45	2
P92 2 CXCBL 2525 M 30 25	30174	L	25	30	25	25	25	25,5	15	3	150	35	2
P92 2 CXCBL 2525 M 30 30	30175	L	30	38	25	25	25	25,5	15	3	150	35	2
P92 2 CXCBL 2525 M 30 38	30179	L	38	48	25	25	25	25,5	15	3	150	35	2
P92 2 CXCBL 2525 M 30 48	30181	L	48	60	25	25	25	25,5	15	3	150	35	2
P92 2 CXCBL 2525 M 30 60	30182	L	60	75	25	25	25	25,5	22	3	150	43	2
P92 2 CXCBL 2525 M 30 75	30184	L	75	100	25	25	25	25,5	25	3	150	45	2
P92 2 CXCBL 2525 M 30 100	30185	L	100	200	25	25	25	25,5	25	3	150	45	2
P92 2 CXCBR 2020 K 30 25	29786	R	25	30	20	20	20	20,5	15	3	125	35	2
P92 2 CXCBR 2020 K 30 30	29787	R	30	38	20	20	20	20,5	15	3	125	35	2
P92 2 CXCBR 2020 K 30 38	29788	R	38	48	20	20	20	20,5	15	3	125	35	2
P92 2 CXCBR 2020 K 30 48	29789	R	48	60	20	20	20	20,5	15	3	125	35	2
P92 2 CXCBR 2020 K 30 60	29790	R	60	75	20	20	20	20,5	22	3	125	43	2
P92 2 CXCBR 2020 K 30 75	29791	R	75	100	20	20	20	20,5	25	3	125	45	2
P92 2 CXCBR 2020 K 30 100	29792	R	100	200	20	20	20	20,5	25	3	125	45	2
P92 2 CXCBR 2525 M 30 25	29793	R	25	30	25	25	25	25,5	15	3	150	35	2
P92 2 CXCBR 2525 M 30 30	29794	R	30	38	25	25	25	25,5	15	3	150	35	2
P92 2 CXCBR 2525 M 30 38	29795	R	38	48	25	25	25	25,5	15	3	150	35	2
P92 2 CXCBR 2525 M 30 48	29796	R	48	60	25	25	25	25,5	15	3	150	35	2
P92 2 CXCBR 2525 M 30 60	29797	R	60	75	25	25	25	25,5	22	3	150	43	2
P92 2 CXCBR 2525 M 30 75	29798	R	75	100	25	25	25	25,5	25	3	150	45	2
P92 2 CXCBR 2525 M 30 100	29799	R	100	200	25	25	25	25,5	25	3	150	45	2

**Remark**

Holder and inserts with the same "S" dimension fit together.

**Fitting inserts**



Torque  
p.205-206,216



p. 46



p. 52

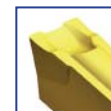

p. 53

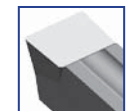

p. 180

**MONOBLOCK Face grooving tool holders for cutting width 4 mm**

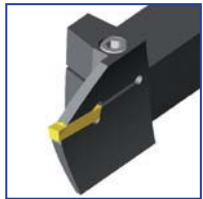

**P92 2 CXCB L**  
System P92-2

LH holder

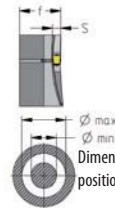
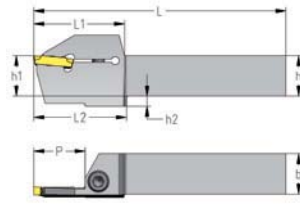

Dimensions refer to the outer position of the cutting edge

**P92 2 CXCB R**  
System P92-2

RH holder

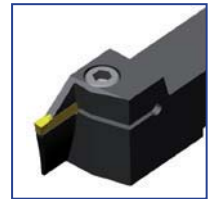

WG388 Ref.	ID-Nr.	( )	Ø min	Ø max	h	h1	h2	b	f	P	S	L	L1	L2	
P92 2 CXCB L 2020 K 40 34	30186	L	34	40	20	20		20	20,5	20	4	125	41		2
P92 2 CXCB L 2020 K 40 40	30187	L	40	48	20	20		20	20,5	25	4	125	45		2
P92 2 CXCB L 2020 K 40 48	30188	L	48	60	20	20		20	20,5	25	4	125	45		2
P92 2 CXCB L 2020 K 40 60	30189	L	60	75	20	20		20	20,5	25	4	125	45		2
P92 2 CXCB L 2020 K 40 75	30190	L	75	150	20	20		20	20,5	25	4	125	45		2
P92 2 CXCB L 2020 K 40 150	29718	L	150	450	20	20	5	20	20,5	25	4	125	45	46	2
P92 2 CXCB L 2525 M 40 34	30192	L	34	40	25	25		25	25,5	20	4	150	41		2
P92 2 CXCB L 2525 M 40 40	30193	L	40	48	25	25		25	25,5	25	4	150	45		2
P92 2 CXCB L 2525 M 40 48	30194	L	48	60	25	25		25	25,5	25	4	150	45		2
P92 2 CXCB L 2525 M 40 60	30195	L	60	75	25	25		25	25,5	25	4	150	45		2
P92 2 CXCB L 2525 M 40 75	30196	L	75	150	25	25		25	25,5	25	4	150	45		2
P92 2 CXCB L 2525 M 40 150	30197	L	150	450	25	25		25	25,5	25	4	150	45		2
P92 2 CXCB L 2525 M 40 450	30198	L	450	∞	25	25	5	25	25,5	25	4	150	45	46	2
P92 2 CXCB R 2020 K 40 34	29742	R	34	40	20	20		20	20,5	20	4	125	41		2
P92 2 CXCB R 2020 K 40 40	29743	R	40	48	20	20		20	20,5	25	4	125	45		2
P92 2 CXCB R 2020 K 40 48	29744	R	48	60	20	20		20	20,5	25	4	125	45		2
P92 2 CXCB R 2020 K 40 60	29745	R	60	75	20	20		20	20,5	25	4	125	45		2
P92 2 CXCB R 2020 K 40 75	29746	R	75	150	20	20		20	20,5	25	4	125	45		2
P92 2 CXCB R 2020 K 40 150	29717	R	150	450	20	20	5	20	20,5	25	4	125	45	46	2
P92 2 CXCB R 2525 M 40 34	29747	R	34	40	25	25		25	25,5	20	4	150	41		2
P92 2 CXCB R 2525 M 40 40	29748	R	40	48	25	25		25	25,5	25	4	150	45		2
P92 2 CXCB R 2525 M 40 48	29749	R	48	60	25	25		25	25,5	25	4	150	45		2
P92 2 CXCB R 2525 M 40 60	29750	R	60	75	25	25		25	25,5	25	4	150	45		2
P92 2 CXCB R 2525 M 40 75	29751	R	75	150	25	25		25	25,5	25	4	150	45		2
P92 2 CXCB R 2525 M 40 150	29719	R	150	450	25	25		25	25,5	25	4	150	45		2
P92 2 CXCB R 2525 M 40 450	29721	R	450	∞	25	25	5	25	25,5	25	4	150	45	46	2

**Remark**

Holder and inserts with the same "S" dimension fit together.

**Fitting inserts**



p.205-206,216



p. 46



p. 52



p. 53

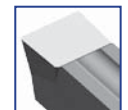

p. 180

**MONOBLOCK Face grooving tool holders for cutting width 5 mm**



**P92 2 CXCBL**  
System P92-2

LH holder

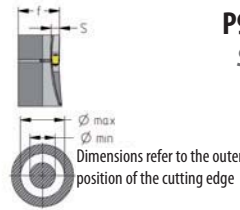
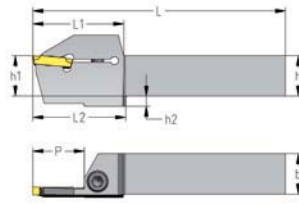

**P92 2 CXCBR**  
System P92-2

RH holder

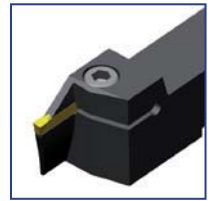

Dimensions refer to the outer position of the cutting edge

WG388 Ref.	ID-Nr.	(C)	Ø min	Ø max	h	h1	h2	b	f	P	S	L	L1	L2	
P92 2 CXCBL 2020 K 50 42	28296	L	42	55	20	20		20	20,5	25	5	125	45		2
P92 2 CXCBL 2020 K 50 55	30199	L	55	75	20	20		20	20,5	25	5	125	45		2
P92 2 CXCBL 2020 K 50 75	29714	L	75	130	20	20	3	20	20,5	28	5	125	48	49	2
P92 2 CXCBL 2525 M 50 42	28298	L	42	55	25	25		25	25,5	25	5	150	45		2
P92 2 CXCBL 2525 M 50 55	30201	L	55	75	25	25		25	25,5	25	5	150	45		2
P92 2 CXCBL 2525 M 50 75	30202	L	75	130	25	25		25	25,5	32	5	150	52		2
P92 2 CXCBL 2525 M 50 75A	30203	L	75	130	25	25		25	25,5	40	5	150	60		2
P92 2 CXCBL 2525 M 50 130	30204	L	130	200	25	25	5	25	25,5	32	5	150	52	53	2
P92 2 CXCBL 2525 M 50 130A	30205	L	130	200	25	25	5	25	25,5	40	5	150	60	61	2
P92 2 CXCBL 2525 M 50 200	30207	L	200	450	25	25	5	25	25,5	32	5	150	52	53	2
P92 2 CXCBL 2525 M 50 200A	30208	L	200	450	25	25	5	25	25,5	45	5	150	65	66	2
P92 2 CXCBL 2525 M 50 450	30210	L	450	∞	25	25	5	25	25,5	32	5	150	52	53	2
P92 2 CXCBL 2525 M 50 450A	30209	L	450	∞	25	25	5	25	25,5	45	5	150	65	66	2
P92 2 CXCBR 2020 K 50 42	28295	R	42	55	20	20		20	20,5	25	5	125	45		2
P92 2 CXCBR 2020 K 50 55	29774	R	55	75	20	20		20	20,5	25	5	125	45		2
P92 2 CXCBR 2020 K 50 75	29713	R	75	130	20	20	3	20	20,5	28	5	125	48	49	2
P92 2 CXCBR 2525 M 50 42	28297	R	42	55	25	25		25	25,5	25	5	150	45		2
P92 2 CXCBR 2525 M 50 55	29775	R	55	75	25	25		25	25,5	25	5	150	45		2
P92 2 CXCBR 2525 M 50 75	29776	R	75	130	25	25		25	25,5	32	5	150	52		2
P92 2 CXCBR 2525 M 50 75A	29777	R	75	130	25	25		25	25,5	40	5	150	60		2
P92 2 CXCBR 2525 M 50 130	29780	R	130	200	25	25	5	25	25,5	32	5	150	52	53	2
P92 2 CXCBR 2525 M 50 130A	29781	R	130	200	25	25	5	25	25,5	40	5	150	60	61	2
P92 2 CXCBR 2525 M 50 200	29782	R	200	450	25	25	5	25	25,5	32	5	150	52	53	2
P92 2 CXCBR 2525 M 50 200A	29784	R	200	450	25	25	5	25	25,5	45	5	150	65	66	2
P92 2 CXCBR 2525 M 50 450	29715	R	450	∞	25	25	5	25	25,5	32	5	150	52	53	2
P92 2 CXCBR 2525 M 50 450A	29785	R	450	∞	25	25	5	25	25,5	45	5	150	65	66	2

**Remark**

Holder and inserts with the same "S" dimension fit together.



p.205-206,216

**Fitting inserts**



p. 46



p. 52



p. 56

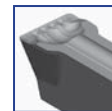

p. 71

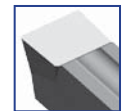

p. 180

**How to write an order:**

1 St. P92 2 CXCBR 2020 K 50 42

or:

**1 St. ID-Nr. 28295**

**recommended**

10 St. RTNX 525 KM TILOX

or:

**10 St. ID-Nr. 13414**

Blades for face grooving

new



**P92 2 TMS**  
System P92-2

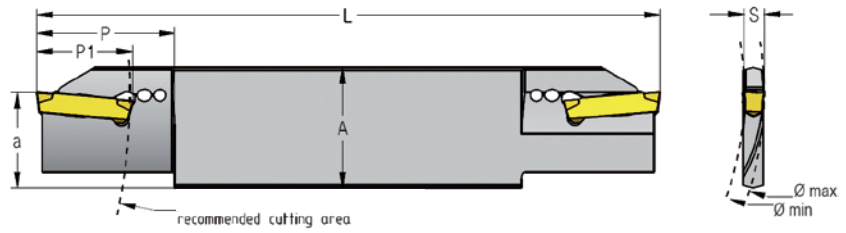

WG311 Ref.	ID-Nr.	( )	Ømin	Ømax	A	a	P	P1	S	L	
P92 2 TMS 32 4 85 R	44531	R	85	160	32	25,0	32	18,5	4,0	160	28
P92 2 TMS 32 4 140 R	44542	R	140	260	32	25,0	32	18,5	4,0	160	28
P92 2 TMS 32 4 240 R	44543	R	240	~	32	25,0	32	18,5	4,0	160	28
P92 2 TMS 32 5 85 R	44538	R	85	160	32	25,0	35	23,5	5,0	160	28
P92 2 TMS 32 5 140 R	44540	R	140	260	32	25,0	35	23,5	5,0	160	28
P92 2 TMS 32 5 240 R	44541	R	240	~	32	25,0	35	23,5	5,0	160	28

Blades and tool blocks with the same "A" dimension fit together.  
Holder and inserts with the same "S" dimension fit together.

Fitting inserts



p.205-206,216



p. 46



p. 52

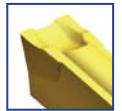

p. 53

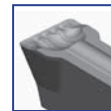

p. 71



p. 143

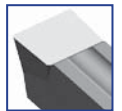

p. 180

Application

P92 2 TMS 32

