





THE FUTURE OF PRECISION MACHINING





# DR-LX

Oil Feed Deep Hole Twist Drill



LONG DRILL					
	EDP No.	Design		Page	Stock
	W05	SB Oil Feed Twist Drills - 135° Point Angle 12 x D, 15 x D, 20 x D, 25 x D, 30 x D		5	○

MICRO LONG DRILL					
	EDP No.	Design		Page	Stock
	H03	Oil Feed Miniature Twist Drills - 135° Point Angle 5 x D, 8 x D, 12 x D, 15 x D, 20 x D, 25 x D 30 x D		14	○

INFO					
		Long Drill Technical Info (Application)		22	

The DR-LX Line with an all-new geometry design and tip coating technology, combined to push wider ranges of cutting speeds and machining conditions whilst extending overall tool life. A package of features and benefits tested with durability, and speed flexibility.

## Suitable for industries :



Automotive

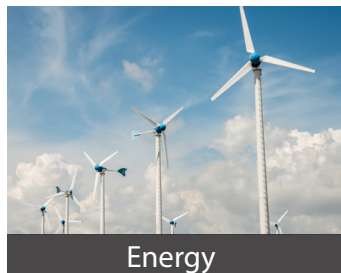

Energy



General Engineering



Mould & Die

## Product Range Graph :

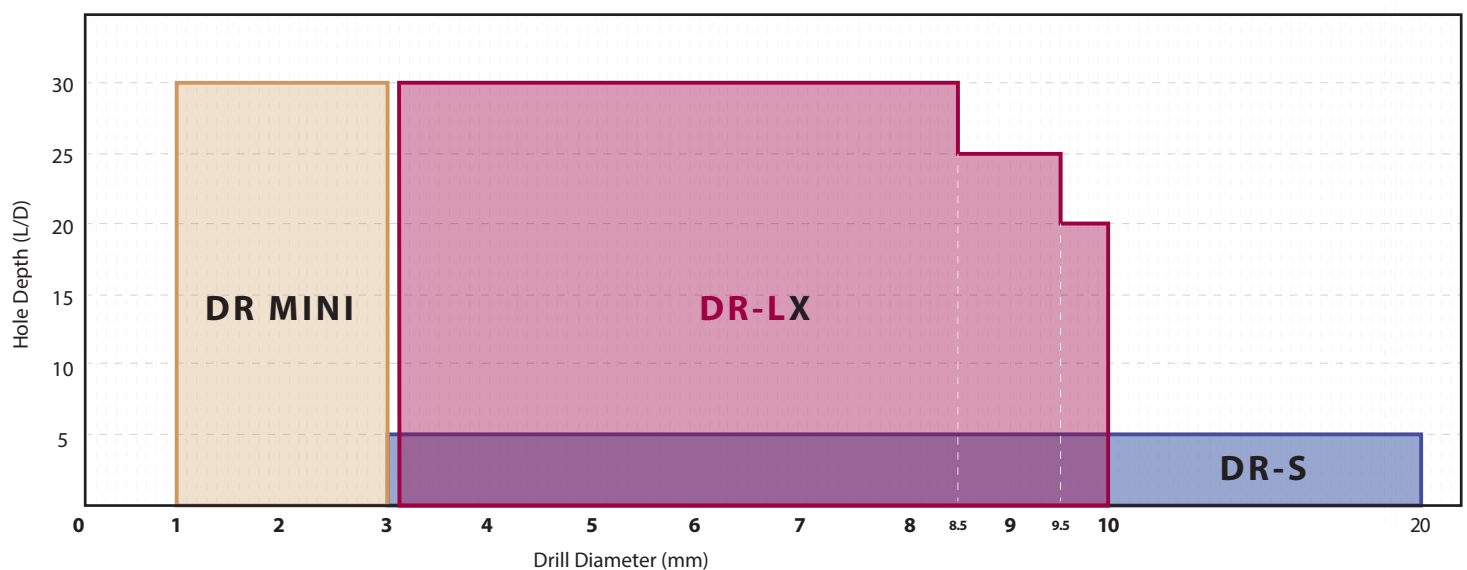

# LONG DRILL



## W05 SB Oil Feed Twist Drill - 135° Point Angle

01

### Polished Flute

- Smoother chips evacuation and less built-up edge

02

### Versatile Machining Condition

- Able to drill reliably with various coolant pressure and cutting data



03

### Flexible Drilling

- Able to drill reliably in continuous and peck drilling

04

### T8090 Coating

- Low friction, high wear resistance

05

### State-of-the-Art Geometry

- For prolonged durability and excellent quality

#### Wider Flute Shape

- Better chip evacuation

#### Tougher Core Diameter

- Ensure chip can evacuate smooth yet rigid

#### GG Point Geometry

- Protect & Reduce Chipping



06

### Suitable for 5 Material Groups



W05\*

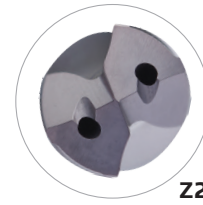

Z2

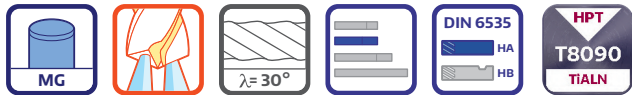

EDP No. / EDV-Nr / CODE usine / Codice EDP	Dimension (mm)								W05 *
	Hole Depth l2/D	D (h7)	l1	l2 (Max. Drilling Depth)	l3	l4	L	d2 (h6)	Normal
0310 12	12 x D	3.1	15.5	45	50	32	85	4	○
0310 15	15 x D		15.5	50	55	32	90	4	○
0310 20	20 x D		15.5	64	69	32	105	4	○
0310 25	25 x D		15.5	79	83	32	120	4	○
0310 30	30 x D	3.2	15.5	94	99	32	135	4	○
0320 12	12 x D		16.0	45	50	32	85	4	○
0330 12	12 x D		16.5	45	50	32	85	4	○
0340 12	12 x D		17.0	48	54	32	90	4	○
0350 12	12 x D	3.5	17.5	48	54	32	90	4	●
0350 15	15 x D		17.5	55	60	32	95	4	●
0350 20	20 x D		17.5	72	77	32	110	4	●
0350 25	25 x D		17.5	89	94	32	130	4	○
0350 30	30 x D	3.6	17.5	106	111	32	145	4	○
0360 12	12 x D		18.0	48	54	32	90	4	○
0370 12	12 x D		18.5	48	54	32	90	4	○
0380 12	12 x D		3.8	19.0	57	64	32	100	4
0380 25	25 x D	19.0		96	102	32	135	4	○
0380 30	30 x D	19.0		115	121	32	155	4	○
0390 12	12 x D	3.9	19.5	57	64	32	100	4	○
0400 12	12 x D	4.0	20.0	57	64	32	100	4	●
0400 15	15 x D		20.0	62	68	32	105	4	●
0400 20	20 x D		20.0	82	88	32	125	4	●
0400 25	25 x D		20.0	101	107	32	140	4	●
0400 30	30 x D		20.0	121	127	32	160	4	○
0410 12	12 x D	4.1	20.5	57	64	34	100	5	○
0410 15	15 x D		20.5	64	70	34	105	5	○

cont'd ►

Material Group | Material-Gruppe | Groupe Matiere | Gruppo Materiali | 材质主类

Cutting Parameter

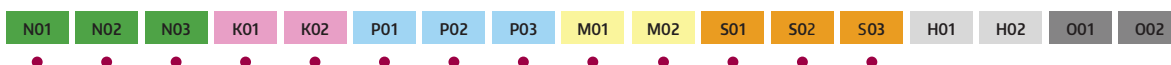

11 - 12

### W05\*

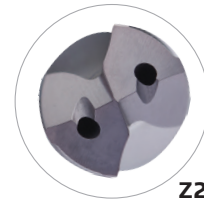
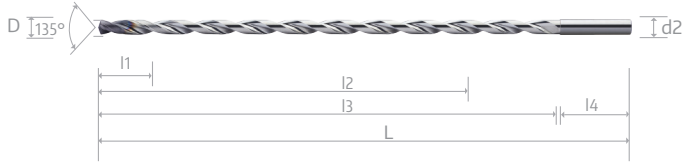

Z2

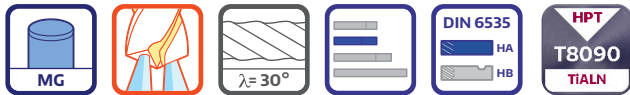

EDP No. / EDV-Nr / CODE usine / Codice EDP	Dimension (mm)								W05 *
	Hole Depth l2/D	D (h7)	l1	l2 (Max. Drilling Depth)	l3	l4	L	d2 (h6)	Normal
0420 12	12 x D		21.0	57	64	34	100	5	○
0420 25	25 x D	4.2	21.0	106	112	34	150	5	○
0420 30	30 x D		21.0	127	133	34	170	5	○
0430 12	12 x D	4.3	21.5	57	64	34	100	5	○
0440 12	12 x D	4.4	22.0	57	64	34	100	5	○
0450 12	12 x D	4.5	22.5	57	64	34	100	5	●
0450 15	15 x D		22.5	70	76	34	115	5	●
0450 20	20 x D		22.5	92	99	34	135	5	●
0450 25	25 x D		22.5	114	120	34	155	5	○
0450 30	30 x D		22.5	136	143	34	180	5	○
0460 12	12 x D	4.6	23.0	57	64	34	100	5	○
0470 12	12 x D	4.7	23.5	57	64	34	100	5	○
0480 12	12 x D	4.8	24.0	67	74	34	110	5	○
0490 12	12 x D	4.9	24.5	72	81	34	120	5	○
0500 12	12 x D	5.0	25.0	72	81	34	120	5	●
0500 15	15 x D		25.0	77	85	34	120	5	●
0500 20	20 x D		25.0	102	110	34	145	5	●
0500 25	25 x D		25.0	126	134	34	170	5	●
0500 30	30 x D		25.0	151	159	34	195	5	●
0510 12	12 x D	5.1	25.5	72	81	36	120	6	○
0510 15	15 x D		25.5	79	86	36	125	6	○
0510 25	25 x D		25.5	129	136	36	175	6	○
0510 30	30 x D		25.5	154	162	36	200	6	○
0520 12	12 x D	5.2	26.0	72	81	36	120	6	○
0530 12	12 x D	5.3	26.5	72	81	36	120	6	○
0540 12	12 x D	5.4	27.0	72	81	36	120	6	○

cont'd ►

Material Group | Material-Gruppe | Groupe Matière | Gruppo Materiali | 材质主类

Cutting Parameter

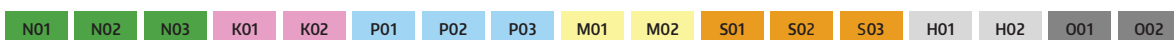

11 - 12

### W05\*

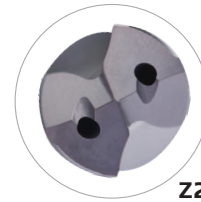

Z2

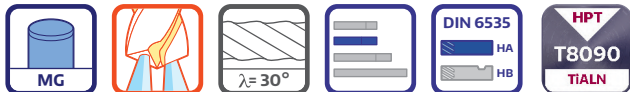

EDP No. / EDV-Nr / CODE usine / Codice EDP	Dimension (mm)								W05 *
	Hole Depth l2/D	D (h7)	l1	l2 (Max. Drilling Depth)	l3	l4	L	d2 (h6)	Normal
0550 12	12 x D		27.5	72	81	36	120	6	•
0550 15	15 x D		27.5	85	93	36	130	6	•
0550 20	20 x D	5.5	27.5	112	120	36	160	6	•
0550 25	25 x D		27.5	139	147	36	185	6	○
0550 30	30 x D		27.5	166	174	36	215	6	○
0560 12	12 x D	5.6	28.0	72	81	36	120	6	○
0570 12	12 x D	5.7	28.5	72	81	36	120	6	○
0580 12	12 x D	5.8	29.0	72	81	36	120	6	○
0590 12	12 x D	5.9	29.5	72	81	36	120	6	○
0600 12	12 x D	6.0	30.0	72	81	36	120	6	•
0600 15	15 x D		30.0	92	101	36	140	6	•
0600 20	20 x D		30.0	122	131	36	170	6	•
0600 25	25 x D		30.0	151	160	36	200	6	○
0600 30	30 x D		30.0	181	190	36	230	6	•
0610 12	12 x D	6.1	30.5	88	97	36	135	8	○
0620 12	12 x D	6.2	31.0	88	97	36	135	8	○
0630 12	12 x D	6.3	31.5	88	97	36	135	8	○
0640 12	12 x D	6.4	32.0	96	108	36	145	8	○
0650 12	12 x D	6.5	32.5	96	108	36	145	8	○
0650 15	15 x D		32.5	100	110	36	150	8	○
0650 20	20 x D		32.5	132	142	36	180	8	○
0650 25	25 x D		32.5	164	173	36	210	8	○
0650 30	30 x D		32.5	196	206	36	245	8	○
0660 12	12 x D	6.6	33.0	96	108	36	145	8	○
0670 12	12 x D	6.7	33.5	96	108	36	145	8	○
0680 12	12 x D	6.8	34.0	96	108	36	145	8	•

cont'd ►

Material Group | Material-Gruppe | Groupe Matière | Gruppo Materiali | 材质主类

Cutting Parameter



11 - 12

### W05\*

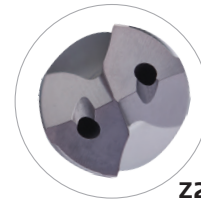

Z2

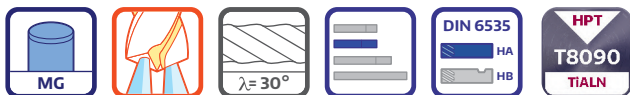

EDP No. / EDV-Nr / CODE usine / Codice EDP	Dimension (mm)								W05 *
	Hole Depth l2/D	D (h7)	l1	l2 (Max. Drilling Depth)	l3	l4	L	d2 (h6)	Normal
0690 12	12 x D	6.9	34.5	96	108	36	145	8	○
0700 12	12 x D	7.0	35.0	96	108	36	145	8	●
0700 15	15 x D		35.0	107	118	38	160	8	●
0700 20	20 x D		35.0	142	153	38	195	8	●
0700 25	25 x D		35.0	176	187	38	230	8	○
0700 30	30 x D		35.0	211	222	38	265	8	●
0710 12	12 x D		7.1	35.5	96	108	36	145	8
0720 12	12 x D	7.2	36.0	96	108	36	145	8	○
0730 12	12 x D	7.3	36.5	96	108	36	145	8	○
0740 12	12 x D	7.4	37.0	96	108	36	145	8	○
0750 12	12 x D	7.5	37.5	96	108	36	145	8	○
0750 15	15 x D		37.5	115	126	38	165	8	○
0750 20	20 x D		37.5	152	163	38	205	8	○
0750 25	25 x D		37.5	189	200	38	240	8	○
0750 30	30 x D		37.5	226	237	38	280	8	○
0760 12	12 x D		7.6	38.0	96	108	36	145	8
0770 12	12 x D	7.7	38.5	96	108	36	145	8	○
0780 12	12 x D	7.8	39.0	96	108	36	145	8	○
0790 12	12 x D	7.9	39.5	96	108	36	145	8	○
0800 12	12 x D	8.0	40.0	96	108	36	145	8	●
0800 15	15 x D		40.0	122	134	40	175	8	●
0800 20	20 x D		40.0	162	174	40	215	8	●
0800 25	25 x D		40.0	201	213	40	255	8	○
0800 30	30 x D		40.0	241	253	40	295	8	○
0810 12	12 x D		8.1	40.5	115	127	40	170	10
0820 12	12 x D	8.2	41.0	120	135	40	180	10	○

cont'd ►

Material Group | Material-Gruppe | Groupe Matiere | Gruppo Materiali | 材质主类

Cutting Parameter

N01	N02	N03	K01	K02	P01	P02	P03	M01	M02	S01	S02	S03	H01	H02	O01	O02	11 - 12
-----	-----	-----	-----	-----	-----	-----	-----	-----	-----	-----	-----	-----	-----	-----	-----	-----	---------



### W05\*

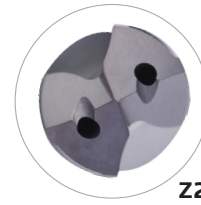
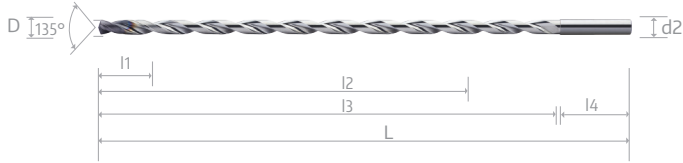

Z2



EDP No. / EDV-Nr / CODE usine / Codice EDP	Dimension (mm)								W05 *
	Hole Depth l2/D	D (h7)	l1	l2 (Max. Drilling Depth)	l3	l4	L	d2 (h6)	Normal
0830 12	12 x D	8.3	41.5	120	135	40	180	10	○
0840 12	12 x D	8.4	42.0	120	135	40	180	10	○
0850 12	12 x D		42.5	120	135	40	180	10	○
0850 15	15 x D		42.5	130	142	40	185	10	○
0850 20	20 x D	8.5	42.5	172	185	40	230	10	○
0850 25	25 x D		42.5	214	226	40	270	10	○
0850 30	30 x D		42.5	258	272	40	315	10	○
0860 12	12 x D	8.6	43.0	120	135	40	180	10	○
0870 12	12 x D	8.7	43.5	120	135	40	180	10	○
0880 12	12 x D	8.8	44.0	120	135	40	180	10	○
0890 12	12 x D	8.9	44.5	120	135	40	180	10	○
0900 12	12 x D	9.0	45.0	120	135	40	180	10	●
0900 15	15 x D		45.0	137	151	40	195	10	●
0900 20	20 x D		45.0	182	196	40	240	10	●
0900 25	25 x D		45.0	226	240	40	285	10	○
0910 12	12 x D		9.1	45.5	120	135	40	180	10
0920 12	12 x D	9.2	46.0	120	135	40	180	10	○
0930 12	12 x D	9.3	46.5	120	135	40	180	10	○
0940 12	12 x D	9.4	47.0	120	135	40	180	10	○
0950 12	12 x D	9.5	47.5	120	135	40	180	10	○
0950 15	15 x D		47.5	145	159	40	200	10	○
0950 20	20 x D		47.5	192	206	40	250	10	○
0960 12	12 x D	9.6	48.0	120	135	40	180	10	○
0970 12	12 x D	9.7	48.5	120	135	40	180	10	○
0980 12	12 x D	9.8	49.0	120	135	40	180	10	○
0980 15	15 x D		49.0	149	164	40	205	10	○

cont'd ►

Material Group | Material-Gruppe | Groupe Matière | Gruppo Materiali | 材质主类

Cutting Parameter



11 - 12

### W05\*

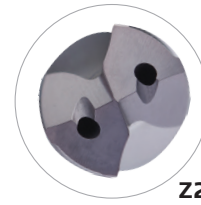

EDP No. / EDV-Nr / CODE usine / Codice EDP	Dimension (mm)								W05 *
	Hole Depth l2/D	D (h7)	l1	l2 (Max. Drilling Depth)	l3	l4	L	d2 (h6)	Normal
0990 12	12 x D	9.9	49.5	120	135	40	180	10	○
1000 12	12 x D	10.0	50.0	120	135	40	180	10	●
1000 15	15 x D		50.0	152	167	40	210	10	●
1000 20	20 x D		50.0	202	217	40	260	10	●



Oil Feed Twist Drills - Point Angle 135°, 12 × Ø - W05

Drilling	P01	P02	P03	M01	M02	K01	K02	N01	N02	N03	S01	S02
Working Material	Carbon Steel	Alloy Steel	Prehardened Steel	Stainless Steel		Grey Cast iron	Ductile Cast Iron	Wrought Aluminium	Cast Aluminium	Copper Alloy	Titanium Alloy	Nickel Alloy
Properties	-	520 < Rm < 1200	35 ≤ HRC < 45	High Machinability		Low Machinability		Si < 9%	Si ≥ 9%	-	-	-
D (mm)	Vc (m/min) fn (mm/rev)	Vc (m/min) fn (mm/rev)	Vc (m/min) fn (mm/rev)	Vc (m/min) fn (mm/rev)	Vc (m/min) fn (mm/rev)	Vc (m/min) fn (mm/rev)	Vc (m/min) fn (mm/rev)	Vc (m/min) fn (mm/rev)	Vc (m/min) fn (mm/rev)	Vc (m/min) fn (mm/rev)	Vc (m/min) fn (mm/rev)	Vc (m/min) fn (mm/rev)
3	0.065	0.058	0.057	0.057	0.052	0.063	0.060	0.080	0.078	0.076	0.052	0.040
4	0.086	0.077	0.076	0.076	0.069	0.084	0.080	0.107	0.104	0.102	0.070	0.052
5	0.108	0.096	0.095	0.094	0.085	0.105	0.099	0.133	0.129	0.126	0.085	0.065
6	95 0.128	85 0.115	70 0.112	65 0.112	45 0.103	90 0.126	70 0.116	150 0.160	130 0.155	120 0.152	35 0.105	30 0.080
7	0.150	0.135	0.133	0.132	0.115	0.147	0.140	0.187	0.181	0.175	0.125	0.091
8	0.173	0.155	0.152	0.152	0.135	0.168	0.160	0.214	0.208	0.203	0.140	0.105
9	0.192	0.170	0.170	0.170	0.155	0.190	0.180	0.240	0.232	0.230	0.150	0.115
10	0.212	0.188	0.186	0.188	0.165	0.208	0.195	0.265	0.255	0.250	0.160	0.130



Oil Feed Twist Drills - Point Angle 135°, 15 × Ø, 20 × Ø - W05

Drilling	P01	P02	P03	M01	M02	K01	K02	N01	N02	N03	S01	S02
Working Material	Carbon Steel	Alloy Steel	Prehardened Steel	Stainless Steel		Grey Cast iron	Ductile Cast Iron	Wrought Aluminium	Cast Aluminium	Copper Alloy	Titanium Alloy	Nickel Alloy
Properties	-	520 < Rm < 1200	35 ≤ HRC < 45	High Machinability		Low Machinability		Si < 9%	Si ≥ 9%	-	-	-
D (mm)	Vc (m/min) fn (mm/rev)	Vc (m/min) fn (mm/rev)	Vc (m/min) fn (mm/rev)	Vc (m/min) fn (mm/rev)	Vc (m/min) fn (mm/rev)	Vc (m/min) fn (mm/rev)	Vc (m/min) fn (mm/rev)	Vc (m/min) fn (mm/rev)	Vc (m/min) fn (mm/rev)	Vc (m/min) fn (mm/rev)	Vc (m/min) fn (mm/rev)	Vc (m/min) fn (mm/rev)
3	0.063	0.058	0.058	0.055	0.042	0.063	0.062	0.080	0.078	0.076	0.052	0.032
4	0.084	0.078	0.078	0.074	0.056	0.085	0.082	0.107	0.104	0.102	0.070	0.045
5	0.105	0.096	0.096	0.090	0.070	0.105	0.102	0.133	0.129	0.126	0.085	0.055
6	90 0.126	70 0.115	60 0.118	55 0.110	45 0.085	85 0.126	60 0.122	140 0.160	120 0.155	110 0.152	35 0.105	30 0.065
7	0.147	0.135	0.133	0.126	0.096	0.147	0.140	0.187	0.181	0.175	0.125	0.075
8	0.168	0.156	0.156	0.150	0.116	0.170	0.163	0.214	0.208	0.203	0.140	0.090
9	0.188	0.175	0.172	0.163	0.128	0.186	0.180	0.240	0.232	0.230	0.150	0.100
10	0.210	0.191	0.190	0.180	0.140	0.204	0.197	0.265	0.255	0.250	0.160	0.110



Recommended Cutting Data

Note: These recommended cutting conditions indicate just references. It should be adjusted due to different cutting conditions.



### Oil Feed Twist Drills - Point Angle 135°, 25 × Ø, 30 × Ø - W05

Drilling	P01		P02		P03		M01		M02		K01		K02		N01		N02		N03		S01		S02	
Working Material	Carbon Steel		Alloy Steel		Prehardened Steel		Stainless Steel				Grey Cast iron		Ductile Cast Iron		Wrought Aluminium		Cast Aluminium		Copper Alloy		Titanium Alloy		Nickel Alloy	
Properties	-		520 < Rm < 1200		35 ≤ HRC < 45		High Machinability		Low Machinability		-		-		Si < 9%		Si ≥ 9%		-		-		-	
D (mm)	Vc (m/min)	fn (mm/rev)	Vc (m/min)	fn (mm/rev)	Vc (m/min)	fn (mm/rev)	Vc (m/min)	fn (mm/rev)	Vc (m/min)	fn (mm/rev)	Vc (m/min)	fn (mm/rev)	Vc (m/min)	fn (mm/rev)	Vc (m/min)	fn (mm/rev)	Vc (m/min)	fn (mm/rev)	Vc (m/min)	fn (mm/rev)	Vc (m/min)	fn (mm/rev)	Vc (m/min)	fn (mm/rev)
3		0.060		0.057		0.057		0.049		0.046		0.061		0.060		0.080		0.078		0.076		0.048		0.030
4		0.080		0.076		0.076		0.066		0.060		0.080		0.080		0.107		0.104		0.102		0.065		0.040
5		0.100		0.094		0.092		0.083		0.075		0.101		0.099		0.133		0.129		0.126		0.080		0.050
6	85	0.118	65	0.113	55	0.112	50	0.100	40	0.090	80	0.120	55	0.118	130	0.160	110	0.155	100	0.152	35	0.100	30	0.060
7		0.140		0.132		0.130		0.115		0.105		0.140		0.135		0.187		0.181		0.175		0.115		0.070
8		0.160		0.151		0.152		0.135		0.120		0.160		0.160		0.214		0.208		0.203		0.135		0.080
9		0.175		0.170		0.170		0.150		0.128		0.178		0.180		0.240		0.232		0.230		0.145		0.090
10		0.195		0.190		0.188		0.165		0.148		0.200		0.195		0.265		0.255		0.250		0.155		0.100



Recommended Cutting Data

Note: These recommended cutting conditions indicate just references. It should be adjusted due to different cutting conditions.

# MICRO LONG DRILL



**H03** Oil Feed Miniature  
Twist Drill - 135° Point Angle

01

## Split Point Design

- Provides self centering ability and reduced thrust

02

## X- Thinning

- Better self-centering on initial cutting

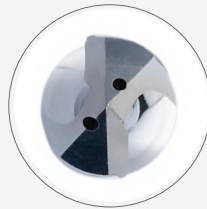

03

## Straight Edge Profile

- Shorter chip and reinforced cutting edge

04

## G6110 Coating

- Monolayer AlCrN coating
- Enhances Tool Life

05

## Polished Flute

- Smoother chips evacuation
- Less build up edge



06

Suitable for 5  
Material Groups

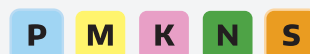

H03\*

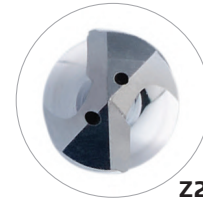

Z2



EDP No. / EDV-Nr / CODE usine / Codice EDP	Dimension (mm)						H03*
	Hole Depth l2/D	D (h7)	l1	l2	L	d2 (h6)	Normal
0100 5	5 x D	1.00	6.5	8.0	50	3	o
0100 8	8 x D		9.5	11.0	50	3	o
0100 12	12 x D		13.5	15.0	55	3	o
0100 20	20 x D		21.5	23.0	65	3	o
0100 25	25 x D		26.5	28.0	70	3	o
0100 30	30 x D	1.10	31.5	33.0	75	3	o
0110 5	5 x D		7.2	8.7	50	3	o
0110 8	8 x D		10.5	12.0	50	3	o
0110 12	12 x D		14.9	16.4	55	3	o
0110 20	20 x D		23.7	25.2	65	3	o
0110 25	25 x D	1.20	29.2	30.7	70	3	o
0110 30	30 x D		34.7	36.2	75	3	o
0120 5	5 x D		7.8	9.3	50	3	o
0120 8	8 x D		11.4	12.9	50	3	o
0120 12	12 x D		16.2	17.7	55	3	o
0120 20	20 x D	1.30	25.8	27.3	65	3	o
0120 25	25 x D		31.8	33.3	75	3	o
0120 30	30 x D		37.8	39.3	75	3	o
0130 5	5 x D		8.5	10.0	50	3	o
0130 8	8 x D		12.4	13.9	50	3	o
0130 12	12 x D	1.30	17.6	19.1	55	3	o
0130 20	20 x D		28.0	29.5	65	3	o
0130 25	25 x D		34.5	36.0	75	3	o
0130 30	30 x D		41.0	42.5	85	3	o

cont'd ►

Material Group | Material-Gruppe | Groupe Matiere | Gruppo Materiali | 材质主类

Cutting Parameter

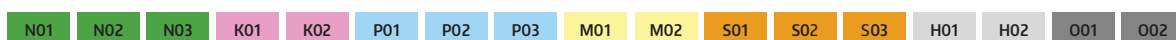

20 - 21

H03\*

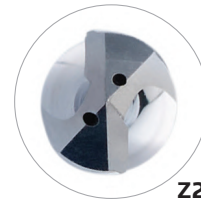

Z2



EDP No. / EDV-Nr / CODE usine / Codice EDP	Dimension ( mm )						H03 *
	Hole Depth l2/D	D (h7)	l1	l2	L	d2 (h6)	Normal
0140 5	5 x D	1.40	9.1	10.6	50	3	o
0140 8	8 x D		13.3	14.8	50	3	o
0140 12	12 x D		18.9	20.4	55	3	o
0140 20	20 x D		30.1	31.6	65	3	o
0140 25	25 x D		37.1	38.6	75	3	o
0140 30	30 x D		44.1	45.6	85	3	o
0150 5	5 x D	1.50	9.8	11.3	50	3	o
0150 8	8 x D		14.3	15.8	50	3	o
0150 12	12 x D		20.3	21.8	55	3	o
0150 20	20 x D		32.3	33.8	75	3	o
0150 25	25 x D		39.8	41.3	80	3	o
0150 30	30 x D		47.3	48.8	85	3	o
0160 5	5 x D	1.60	10.4	11.9	50	3	o
0160 8	8 x D		15.2	16.7	50	3	o
0160 12	12 x D		21.6	23.1	65	3	o
0160 20	20 x D		34.4	35.9	75	3	o
0160 25	25 x D		42.4	43.9	80	3	o
0160 30	30 x D		50.4	51.9	90	3	o
0170 5	5 x D	1.70	11.1	12.6	55	3	o
0170 8	8 x D		16.2	17.7	60	3	o
0170 12	12 x D		23.0	24.5	65	3	o
0170 20	20 x D		36.6	38.1	75	3	o
0170 25	25 x D		45.1	46.6	80	3	o
0170 30	30 x D		53.6	55.1	90	3	o

cont'd ►

Material Group | Material-Gruppe | Groupe Matiere | Gruppo Materiali | 材质主类

Cutting Parameter



20 - 21

H03\*

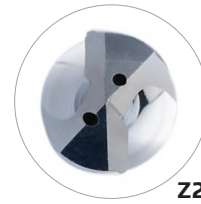

Z2



EDP No. / EDV-Nr / CODE usine / Codice EDP	Dimension (mm)						H03 *
	Hole Depth l2/D	D (h7)	l1	l2	L	d2 (h6)	Normal
0180 5	5 x D	1.80	11.7	13.2	55	3	o
0180 8	8 x D		17.1	18.6	60	3	o
0180 12	12 x D		24.3	25.8	65	3	o
0180 20	20 x D		38.7	40.2	75	3	o
0180 25	25 x D		47.7	49.2	90	3	o
0180 30	30 x D		56.7	58.2	100	3	o
0190 5	5 x D	1.90	12.4	13.9	55	3	o
0190 8	8 x D		18.1	19.6	60	3	o
0190 12	12 x D		25.7	27.2	65	3	o
0190 20	20 x D		40.9	42.4	75	3	o
0190 25	25 x D		50.4	51.9	90	3	o
0190 30	30 x D		59.9	61.4	100	3	o
0200 5	5 x D	2.00	13.0	16.0	55	3	o
0200 8	8 x D		19.0	22.0	60	3	o
0200 12	12 x D		27.0	30.0	65	3	o
0200 20	20 x D		43.0	46.0	82	3	o
0200 25	25 x D		53.0	56.0	90	3	o
0200 30	30 x D		63.0	66.0	100	3	o
0210 5	5 x D	2.10	13.7	16.9	55	3	o
0210 8	8 x D		20.0	23.2	60	3	o
0210 12	12 x D		28.4	31.6	65	3	o
0210 20	20 x D		45.2	48.4	82	3	o
0210 25	25 x D		55.7	58.8	100	3	o
0210 30	30 x D		66.2	69.3	110	3	o

cont'd ►

Material Group | Material-Gruppe | Groupe Matière | Gruppo Materiali | 材质主类

Cutting Parameter

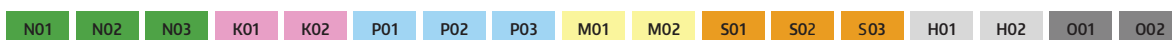

20 - 21



H03\*

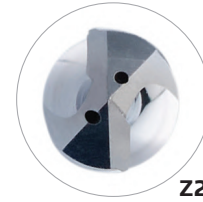

Z2



EDP No. / EDV-Nr / CODE usine / Codice EDP	Dimension ( mm )						H03 *
	Hole Depth l2/D	D (h7)	l1	l2	L	d2 (h6)	Normal
0220 5	5 x D	2.20	14.3	17.6	55	3	o
0220 8	8 x D		20.9	24.2	60	3	o
0220 12	12 x D		29.7	33.0	65	3	o
0220 20	20 x D		47.3	50.6	82	3	o
0220 25	25 x D		58.3	61.6	100	3	o
0220 30	30 x D		69.3	72.6	110	3	o
0230 5	5 x D	2.30	15.0	18.5	55	3	o
0230 8	8 x D		21.9	25.4	60	3	o
0230 12	12 x D		31.1	34.6	65	3	o
0230 20	20 x D		49.5	53.0	100	3	o
0230 25	25 x D		61.0	64.4	100	3	o
0230 30	30 x D		72.5	75.9	110	3	o
0240 5	5 x D	2.40	15.6	19.2	55	3	o
0240 8	8 x D		22.8	26.4	60	3	o
0240 12	12 x D		32.4	36.0	75	3	o
0240 20	20 x D		51.6	55.2	100	3	o
0240 25	25 x D		63.6	67.2	100	3	o
0240 30	30 x D		75.6	79.2	120	3	o
0250 5	5 x D	2.50	16.3	21.0	55	3	o
0250 8	8 x D		23.8	27.6	60	3	o
0250 12	12 x D		33.8	37.6	75	3	o
0250 20	20 x D		53.8	57.6	100	3	o
0250 25	25 x D		66.3	70.0	110	3	o
0250 30	30 x D		78.8	82.5	120	3	o

cont'd ►

Material Group | Material-Gruppe | Groupe Matiere | Gruppo Materiali | 材质主类

Cutting Parameter



20 - 21

H03\*

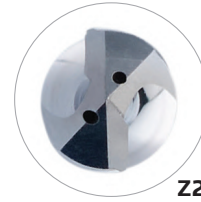

Z2

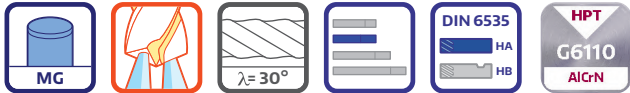

EDP No. / EDV-Nr / CODE usine / Codice EDP	Dimension ( mm )						H03 *
	Hole Depth l2/D	D (h7)	l1	l2	L	d2 (h6)	Normal
0260 5	5 x D	2.60	16.9	20.8	55	3	o
0260 8	8 x D		24.7	28.6	60	3	o
0260 12	12 x D		35.1	39.0	75	3	o
0260 20	20 x D		55.9	59.8	100	3	o
0260 25	25 x D		68.9	72.8	110	3	o
0260 30	30 x D	81.9	85.8	120	3	o	
0270 5	5 x D	2.70	17.6	21.7	55	3	o
0270 8	8 x D		25.7	29.8	60	3	o
0270 12	12 x D		36.5	40.6	75	3	o
0270 20	20 x D		58.1	62.2	100	3	o
0270 25	25 x D		71.6	75.6	110	3	o
0270 30	30 x D	85.1	89.1	130	3	o	
0280 5	5 x D	2.80	18.2	22.4	55	3	o
0280 8	8 x D		26.6	30.8	60	3	o
0280 12	12 x D		37.8	42.0	75	3	o
0280 20	20 x D		60.2	64.4	100	3	o
0280 25	25 x D		74.2	78.4	110	3	o
0280 30	30 x D	88.2	92.4	130	3	o	
0290 5	5 x D	2.90	18.9	23.3	55	3	o
0290 8	8 x D		27.6	32.0	60	3	o
0290 12	12 x D		39.2	43.6	75	3	o
0290 20	20 x D		61.4	65.8	100	3	o
0290 25	25 x D		76.9	81.2	120	3	o
0290 30	30 x D	91.4	95.7	130	3	o	

cont'd ►

Material Group | Material-Gruppe | Groupe Matiere | Gruppo Materiali | 材质主类

Cutting Parameter

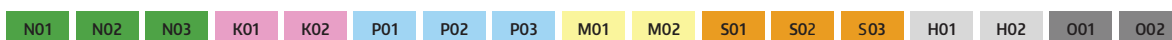

20 - 21

H03\*

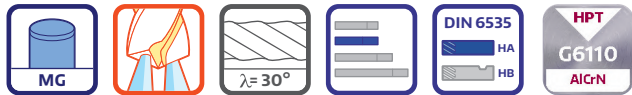
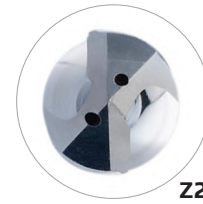

EDP No. / EDV-Nr / CODE usine / Codice EDP	Dimension ( mm )						H03 *
	Hole Depth l2/D	D (h7)	l1	l2	L	d2 (h6)	Normal
0300 5	5 x D	3.00	19.5	24.0	55	3	o
0300 8	8 x D		28.5	33.0	60	3	o
0300 12	12 x D		40.5	45.0	75	3	o
0300 20	20 x D		64.5	69.0	100	3	o
0300 25	25 x D		79.5	84.0	120	3	o
0300 30	30 x D		94.5	99.0	130	3	o

Material Group | Material-Gruppe | Groupe Matiere | Gruppo Materiali | 材质主类

Cutting Parameter



20 - 21



## Oil Feed Miniature Twist Drill - Point Angle 135°, 5 × Ø, 8 × Ø - H03

Drilling	P01	P02	P03	M01	M02	K01	K02	N01	N02	N03	S01	S02
Working Material	Carbon Steel	Alloy Steel	Prehardened Steel	Stainless Steel		Grey Cast iron	Ductile Cast Iron	Wrought Aluminium	Cast Aluminium	Copper Alloy	Titanium Alloy	Nickel Alloy
Properties	-	520 < Rm < 1200	35 ≤ HRC < 45	High Machinability		Low Machinability		Si < 9%	Si ≥ 9%	-	-	-
D (mm)	Vc (m/min) fn (mm/rev)	Vc (m/min) fn (mm/rev)	Vc (m/min) fn (mm/rev)	Vc (m/min) fn (mm/rev)	Vc (m/min) fn (mm/rev)	Vc (m/min) fn (mm/rev)	Vc (m/min) fn (mm/rev)	Vc (m/min) fn (mm/rev)	Vc (m/min) fn (mm/rev)	Vc (m/min) fn (mm/rev)	Vc (m/min) fn (mm/rev)	Vc (m/min) fn (mm/rev)
1	27 0.042	23 0.042	28 0.016	25 0.016	20 0.013	33 0.021	26 0.013	43 0.063	41 0.060	39 0.057	9 0.013	8 0.011
1.5	40 0.047	35 0.047	41 0.021	33 0.021	26 0.017	46 0.026	31 0.016	64 0.079	61 0.075	57 0.071	10 0.016	8 0.013
2	52 0.053	47 0.053	47 0.032	36 0.037	29 0.029	60 0.032	39 0.021	84 0.084	79 0.080	75 0.076	12 0.021	10 0.018
2.5	64 0.058	57 0.058	59 0.037	37 0.042	30 0.034	71 0.047	38 0.026	98 0.095	93 0.090	89 0.085	12 0.032	10 0.027
3	74 0.063	68 0.063	68 0.053	40 0.053	31 0.042	80 0.058	40 0.032	106 0.105	100 0.100	95 0.095	13 0.053	11 0.045



## Oil Feed Miniature Twist Drill - Point Angle 135°, 12 × Ø, 15 × Ø - H03

Drilling	P01	P02	P03	M01	M02	K01	K02	N01	N02	N03	S01	S02
Working Material	Carbon Steel	Alloy Steel	Prehardened Steel	Stainless Steel		Grey Cast iron	Ductile Cast Iron	Wrought Aluminium	Cast Aluminium	Copper Alloy	Titanium Alloy	Nickel Alloy
Properties	-	520 < Rm < 1200	35 ≤ HRC < 45	High Machinability		Low Machinability		Si < 9%	Si ≥ 9%	-	-	-
D (mm)	Vc (m/min) fn (mm/rev)	Vc (m/min) fn (mm/rev)	Vc (m/min) fn (mm/rev)	Vc (m/min) fn (mm/rev)	Vc (m/min) fn (mm/rev)	Vc (m/min) fn (mm/rev)	Vc (m/min) fn (mm/rev)	Vc (m/min) fn (mm/rev)	Vc (m/min) fn (mm/rev)	Vc (m/min) fn (mm/rev)	Vc (m/min) fn (mm/rev)	Vc (m/min) fn (mm/rev)
1	26 0.040	22 0.040	27 0.015	24 0.015	19 0.012	31 0.020	25 0.012	41 0.060	39 0.057	37 0.054	9 0.012	8 0.010
1.5	38 0.045	33 0.045	39 0.020	31 0.020	25 0.016	44 0.025	30 0.015	61 0.075	58 0.071	55 0.068	9 0.015	8 0.013
2	50 0.050	44 0.050	45 0.030	35 0.035	28 0.028	57 0.030	37 0.020	80 0.080	75 0.076	72 0.072	11 0.020	9 0.017
2.5	61 0.055	54 0.055	56 0.035	35 0.040	28 0.032	68 0.045	36 0.025	94 0.090	90 0.086	85 0.081	12 0.030	9 0.026
3	72 0.060	64 0.060	65 0.050	38 0.050	30 0.040	76 0.055	38 0.030	101 0.100	95 0.095	90 0.090	12 0.050	10 0.043



Recommended Cutting Data

Note: These recommended cutting conditions indicate just references. It should be adjusted due to different cutting conditions.



## Oil Feed Miniature Twist Drill - Point Angle 135°, 20 × Ø, 25 × Ø - H03

Drilling	P01	P02	P03	M01	M02	K01	K02	N01	N02	N03	S01	S02
Working Material	Carbon Steel	Alloy Steel	Prehardened Steel	Stainless Steel		Grey Cast iron	Ductile Cast Iron	Wrought Aluminium	Cast Aluminium	Copper Alloy	Titanium Alloy	Nickel Alloy
Properties	-	520 < Rm < 1200	35 ≤ HRC < 45	High Machinability		Low Machinability		Si < 9%	Si ≥ 9%	-	-	-
D (mm)	Vc (m/min) fn (mm/rev)	Vc (m/min) fn (mm/rev)	Vc (m/min) fn (mm/rev)	Vc (m/min) fn (mm/rev)	Vc (m/min) fn (mm/rev)	Vc (m/min) fn (mm/rev)	Vc (m/min) fn (mm/rev)	Vc (m/min) fn (mm/rev)	Vc (m/min) fn (mm/rev)	Vc (m/min) fn (mm/rev)	Vc (m/min) fn (mm/rev)	Vc (m/min) fn (mm/rev)
1	25 0.040	21 0.040	26 0.015	22 0.015	18 0.012	30 0.020	24 0.012	39 0.060	37 0.057	35 0.054	8 0.012	7 0.010
1.5	36 0.045	32 0.045	37 0.020	29 0.020	24 0.016	42 0.025	28 0.015	58 0.075	55 0.071	52 0.068	9 0.015	8 0.013
2	48 0.050	42 0.050	43 0.030	33 0.035	26 0.028	54 0.030	35 0.020	75 0.080	72 0.076	68 0.072	11 0.020	9 0.017
2.5	58 0.055	52 0.055	53 0.035	34 0.040	27 0.032	64 0.045	34 0.025	90 0.090	85 0.086	80 0.081	11 0.030	9 0.026
3	68 0.060	61 0.060	62 0.050	36 0.050	28 0.040	73 0.055	36 0.030	95 0.100	90 0.095	86 0.090	11 0.050	9 0.043



## Oil Feed Miniature Twist Drill - Point Angle 135°, 30 × Ø - H03

Drilling	P01	P02	P03	M01	M02	K01	K02	N01	N02	N03	S01	S02
Working Material	Carbon Steel	Alloy Steel	Prehardened Steel	Stainless Steel		Grey Cast iron	Ductile Cast Iron	Wrought Aluminium	Cast Aluminium	Copper Alloy	Titanium Alloy	Nickel Alloy
Properties	-	520 < Rm < 1200	35 ≤ HRC < 45	High Machinability		Low Machinability		Si < 9%	Si ≥ 9%	-	-	-
D (mm)	Vc (m/min) fn (mm/rev)	Vc (m/min) fn (mm/rev)	Vc (m/min) fn (mm/rev)	Vc (m/min) fn (mm/rev)	Vc (m/min) fn (mm/rev)	Vc (m/min) fn (mm/rev)	Vc (m/min) fn (mm/rev)	Vc (m/min) fn (mm/rev)	Vc (m/min) fn (mm/rev)	Vc (m/min) fn (mm/rev)	Vc (m/min) fn (mm/rev)	Vc (m/min) fn (mm/rev)
1	26 0.040	22 0.040	27 0.015	24 0.015	19 0.012	31 0.020	25 0.012	41 0.060	39 0.057	37 0.054	9 0.012	8 0.010
1.5	38 0.045	33 0.045	39 0.020	31 0.020	25 0.016	44 0.025	30 0.015	61 0.075	58 0.071	55 0.068	9 0.015	8 0.013
2	50 0.050	44 0.050	45 0.030	35 0.035	28 0.028	57 0.030	37 0.020	80 0.080	75 0.076	72 0.072	11 0.020	9 0.017
2.5	61 0.055	54 0.055	56 0.035	35 0.040	28 0.032	68 0.045	36 0.025	94 0.090	90 0.086	85 0.081	12 0.030	9 0.026
3	72 0.060	64 0.060	65 0.050	38 0.050	30 0.040	76 0.055	38 0.030	101 0.100	95 0.095	90 0.090	12 0.050	10 0.043



Recommended Cutting Data

Note: These recommended cutting conditions indicate just references. It should be adjusted due to different cutting conditions.

**Drilling on Standard Through Hole**

\* For references only.

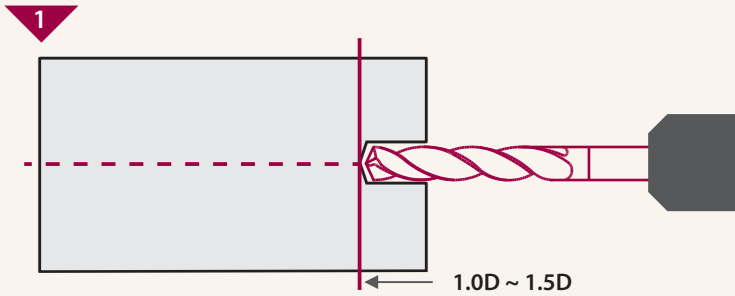

**Develop pilot bore**

- Using a 3xD pilot drill (DR45/DR-S) with point angle 140° and tolerance m7 (4 - 25 micron > Ø deep hole drill)
- Drilling pilot bore depth with minimum of 1 to 1.5D

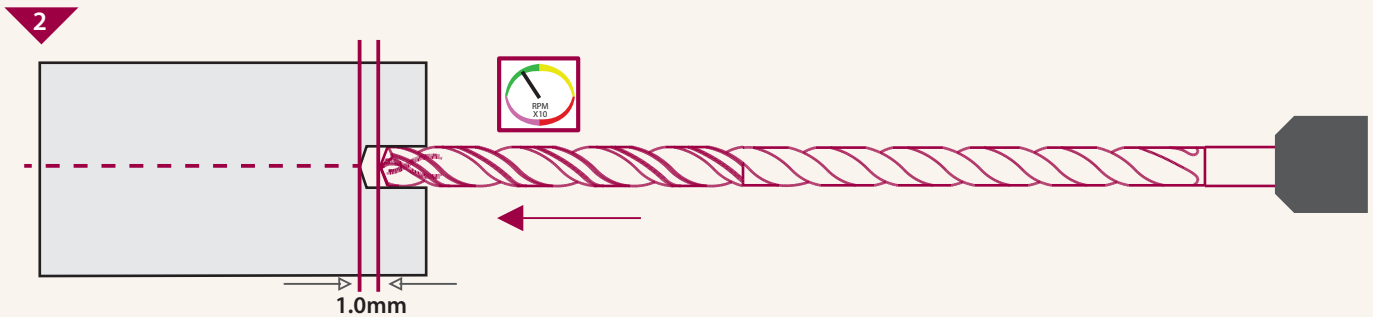

**Enter according to pilot bore**

- Enter without coolant be upon 1mm before the end of pilot bore
- Approximate 300 rpm and feedrate of 500 mm/min
- Then start high pressure coolant

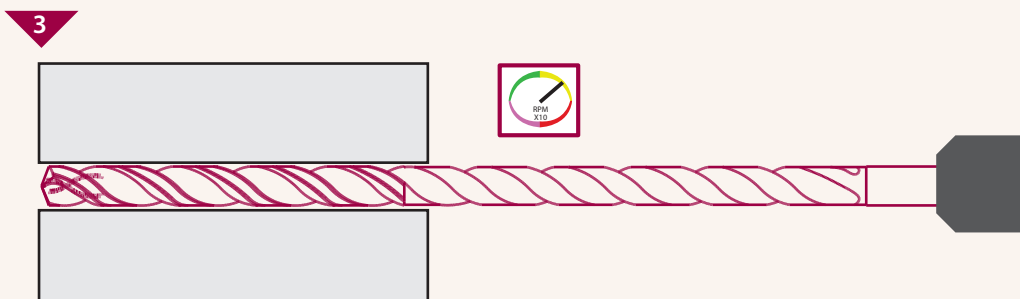

**Deep drilling process**

- Load higher spindle speed (Vc) and feedrate (f) as per recommended
- Continuous drilling upon complete hole depth without chip removal cycles/peck drilling cycles
- For through holes, reduce 30% of feedrate approximate 1mm before complete the hole depth

**Drilling on Standard Through Hole**

\* For references only.

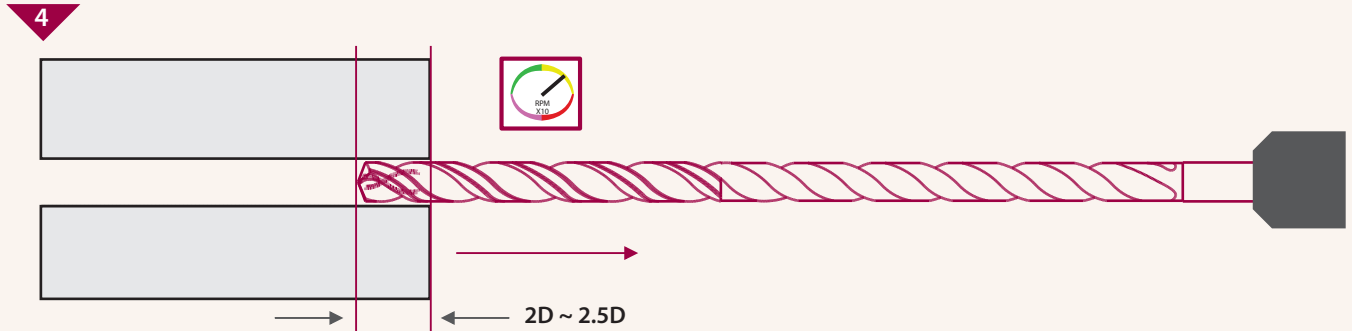

**Withdrawal**

- Switch off coolant supply
- Withdraw the long drills after completed drilling the hole depth
- Existing spindle speed (Vc) and double up the feedrate (f)
- Withdraw towards approximate 2 to 2.5D of the beginning part of pilot bore

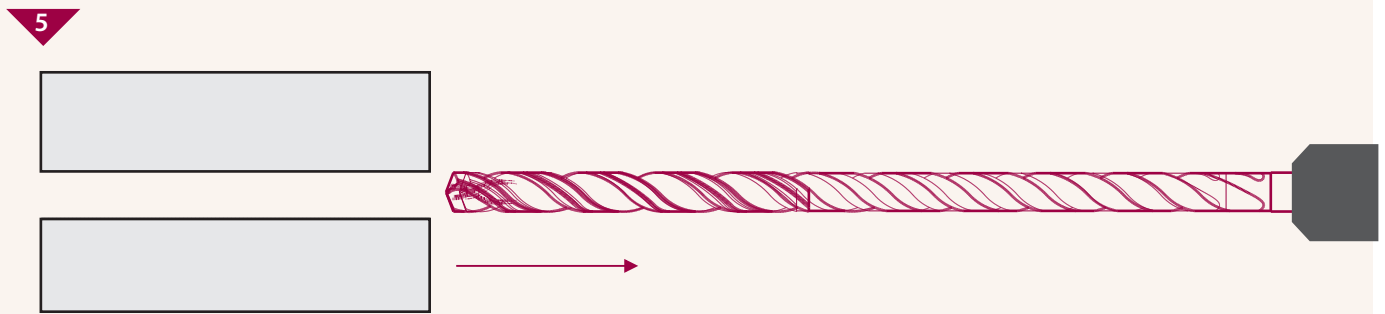

**Discharge from the bore**

- Discharge with lower and stationary speed from the remaining part

**Drilling on Standard Through Hole**

\* For references only.

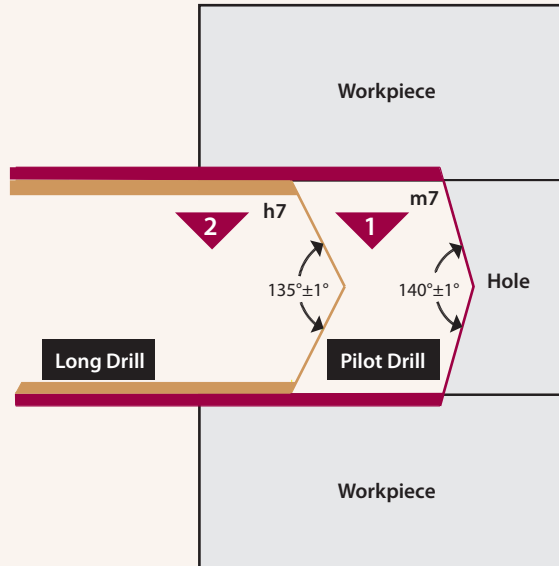

**1**

**Pilot Bore**

Please use the corresponding drill with internal coolant supply and the same nominal diameter for the pilot bore.  
Pilot Drill Series I **DR S (140° I D(m7))**

Tolerance consideration for m7 in  $\mu\text{m}$

Diameter	Tolerance, $\mu\text{m}$
$\leq \text{Ø}3$	+2 ~ +12
$\text{Ø}4 - \text{Ø}6$	+4 ~ +16
$\text{Ø}7 - \text{Ø}10$	+6 ~ +21

**2**

**Deep Hole Bore (12xD - 30xD)**

Please use the corresponding drill with internal coolant supply and the same nominal diameter for the deep hole bore.  
Long Drill Series I **DR-L (135° I D(h7))**

Tolerance consideration for h7 in  $\mu\text{m}$

Diameter	Tolerance, $\mu\text{m}$
$\leq \text{Ø}3$	0 ~ -10
$\text{Ø}4 - \text{Ø}6$	0 ~ -12
$\text{Ø}7 - \text{Ø}10$	0 ~ -15



Drilling On Irregular Faces or Angles

\* For references only.

1

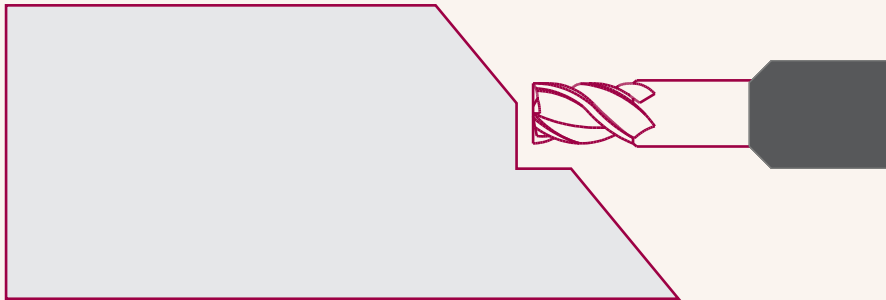

**Spot Facing**

- Make a flat surface by using an endmill (HPMT 918) with light slotting on the irregular faces/angles
- Machining the width and depth of spot face same size as the required deep hole diameter
- Endmill used required the capability of spot facing (ramping/plunging)

2

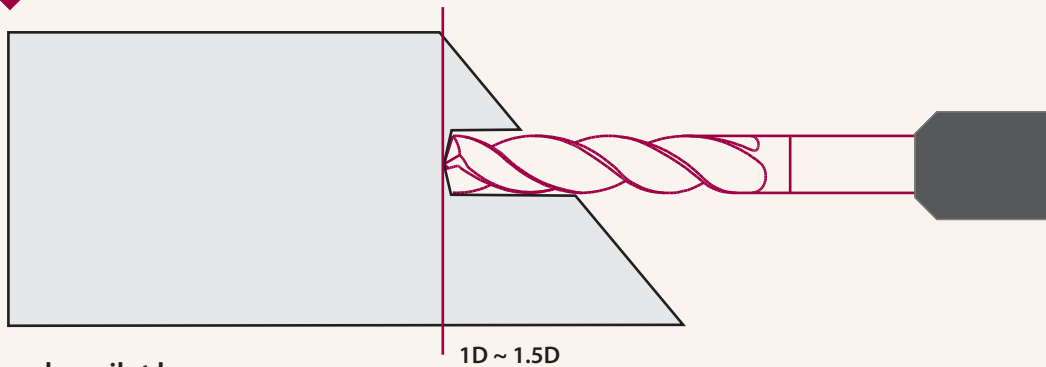

**Develop pilot bore**

- Using a 3xD pilot drill (DR-S) with point angle 140° & tolerance m7 ( 4 - 25 micron > Ø deep hole drill)
- Drilling pilot bore depth with minimum of 1 to 1.5D

3

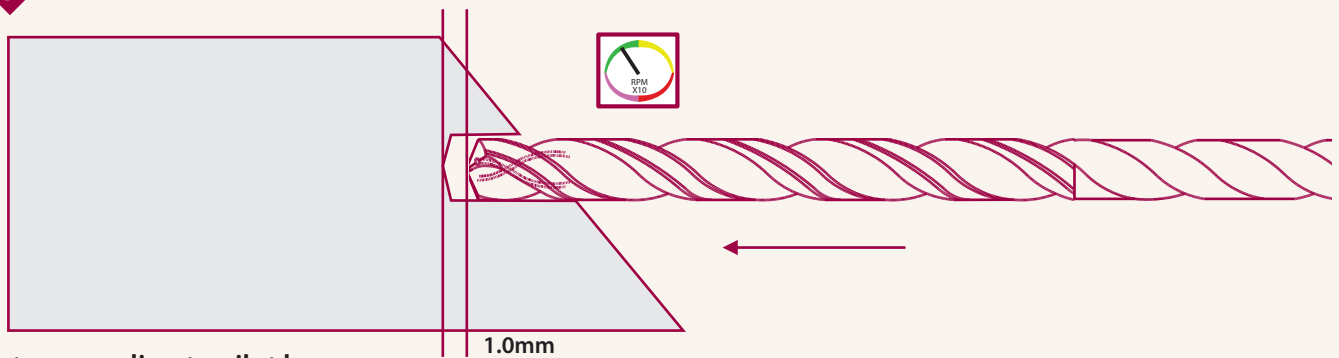

**Enter according to pilot bore**

- Enter without coolant be upon 1mm before the end of pilot bore
- Approximate 300 rpm and feedrate of 500 mm/min
- Then start high pressure coolant

Drilling On Irregular Faces or Angles

\* For references only.

4

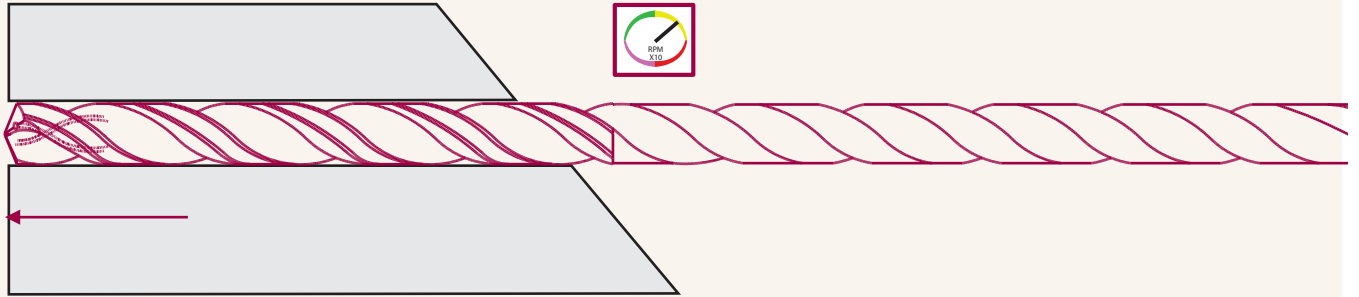

**Deep drilling process**

- Load higher spindle speed (Vc) and feedrate (f) as per recommended
- Continuous drilling upon complete hole depth without chip removal cycles/peck drilling cycles
- For through holes, reduce 30% of feedrate approximate 1mm before complete the hole depth

5

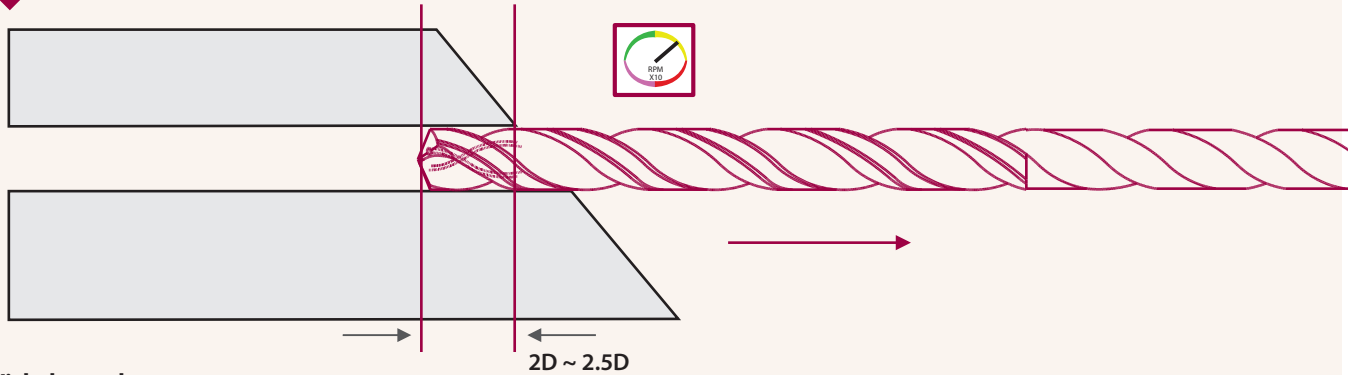

**Withdrawal**

- Switch off coolant supply
- Withdraw the long drills after completed drilling the hole depth
- Existing spindle speed (Vc) and double up the feedrate (f)
- Withdraw towards approximate 2 to 2.5D of the beginning part of pilot bore

6

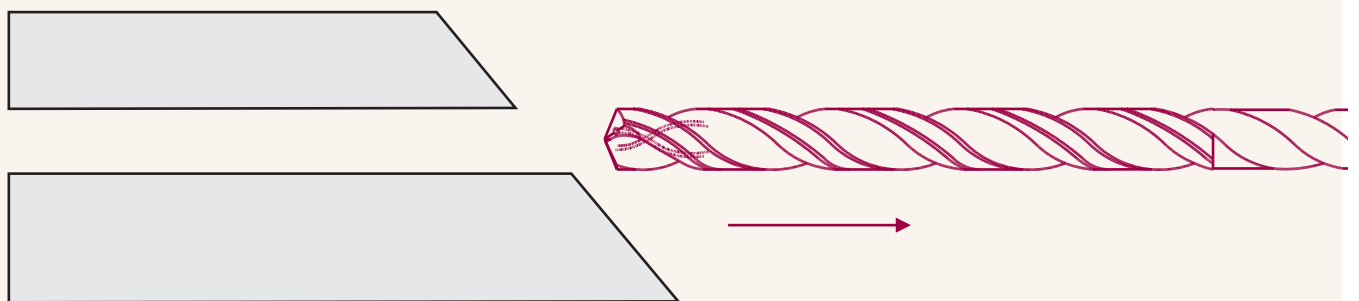

**Discharge from the bore**

- Discharge with lower and stationary speed from the remaining part

# Certificate

Standard **ISO 9001:2015**

Certificate Registr. No. **01 100 053515**

Certificate Holder:



**HPMT Industries Sdn. Bhd.**  
No. 5, Jalan Sungai Kayu Ara 32/39, Taman Berjaya,  
Seksyen 32, Shah Alam, Selangor Darul Ehsan, Malaysia

Scope:

Manufacturing of Standard and Custom-made Metal Removing  
Cutting Tools

Proof has been furnished by means of an audit that the  
requirements of ISO 9001:2015 are met.

Validity:

The certificate is valid from 2018-09-04 until 2021-08-14.

2018-09-14

A handwritten signature in blue ink, appearing to read 'K. Jiegler', is written over a horizontal line.

TÜV Rheinland Cert GmbH  
Am Grauen Stein · 51105 Köln



THE FUTURE OF PRECISION MACHINING

#### HPMT INDUSTRIES SDN BHD

5 Jalan Sungai Kayu Ara 32/39  
Taman Berjaya, Seksyen 32  
40460 Shah Alam,  
Selangor Darul Ehsan, Malaysia

**T** + 603 5740 2218  
**F** + 603 5740 2238  
**E** [info@hpmt-industries.com](mailto:info@hpmt-industries.com)  
**W** [www.hpmt-industries.com](http://www.hpmt-industries.com)

#### HERROZ SDN BHD

5 Jalan Sungai Kayu Ara 32/39  
Taman Berjaya, Seksyen 32  
40460 Shah Alam,  
Selangor Darul Ehsan, Malaysia

**T** + 603 5740 2838 (Selangor)  
+ 607 351 9910 (Johor)  
**F** + 603 5740 2822 (Selangor)  
+ 603 5740 2823 (Selangor)  
+ 607 355 2461 (Johor)  
**E** [info@herroz.com](mailto:info@herroz.com)  
**W** [www.herroz.com](http://www.herroz.com)

#### MTC TOOLING SYSTEMS LTD

204-5 Fook Hong Ind Bldg  
19 Shueng Yuet Road  
Kowloon Bay, Hong Kong

**T** 00852 2305 4838  
**F** 00852 2798 8789  
**E** [info@mtc-tools.com](mailto:info@mtc-tools.com)

#### HPMT (SHEN ZHEN) LTD

1223, Kerry Centre  
2008 Renminnan Road  
ShenZhen China

**T** 00755 2518 1722  
**F** 00755 2518 1728  
**E** [info@hpmt-industries.com.cn](mailto:info@hpmt-industries.com.cn)  
**W** [www.hpmt-industries.com.cn](http://www.hpmt-industries.com.cn)

#### HPMT DEUTSCHLAND GMBH

Vorkamp 6, D-23879 Mölln

**T** + 49 (0) 45 42 / 84 21 10  
**F** + 49 (0) 45 42 / 84 21 08  
**E** [info@hpmt-deutschland.de](mailto:info@hpmt-deutschland.de)  
**W** [www.hpmt-deutschland.de](http://www.hpmt-deutschland.de)



# ZIBTRPRO

tehnologija obdelave · vpenjalni sistemi