

DOMX

The revolution on HRSA Turning

TURNING
HRSA



WEBSITE



VIDEO



DOMX[®]

DOMX® - the revolution in HRSA medium to rough turning

Proprietary turning line

Designed especially for HRSA, the DOMX® combined with PHH technology, offers exceptional performance in exotic materials machining. When your material has high Ni or Co content DOMX® is the choice!

- 🔗 First choice for **HRSA** medium to rough turning;
- 🔗 **4 positive cutting edges on double sided negative insert.**

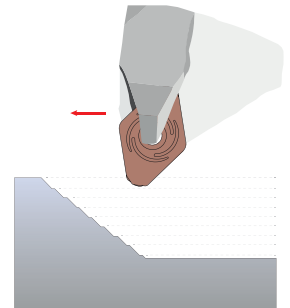

- 🔗 Machine at 45° with a 93° holder;
- 🔗 **Up to + 140% tool life improvement.**

PHH GRADE Grau PHH | Grado PHH

Product of the latest coating technology, the new PHH coating comes to revolutionize the turning of HRSA. PHH is a stable PVD coating that merges both high hardness and unmatched heat resistance.

PHH910

S05-S15





First choice for HRSA.

PHH920

S15-S30

Solution for general turning of HRSA.

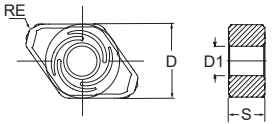
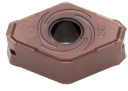
	1	5	10	15	20	25	30	
S HEAT RESISTANT / TITANIUM ALLOYS			PHH910					PVD
				PHH920				

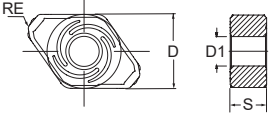

Inserts Pastilhas Plaquetas	⁽¹⁾ Geometry code	⁽²⁾ Grade code	S		Dimensions (mm) Dimensões (mm) Dimensiones (mm)				Cutting Conditions Condições de Corte Condiciones de Corte					Technical drawing Desenho técnico Dibujo técnico	
			PVD		D	S	RE	D1	AP (mm)	MIN	MAX	FN (mm/rev)	MIN		MAX
			X6	Y3											
	1124595	DOMX 1506R1-GS			12,70	6,35	0,80	5,16	1,50	0,30	1,50	0,30	0,20	0,50	
	1124493	DOMX 1506L1-GS			12,70	6,35	0,80	5,16	1,50	0,30	1,50	0,30	0,20	0,50	

 First choice | 1ª Escolha | 1ª Opción  Stock Items | Itens de stock

Insert Order Code: ⁽¹⁾ Geometry code + ⁽²⁾ Grade code

A - DDJN-DX1 45° Toolholders

(D) Dimple lock toolholders

Roughing to Heavy Roughing	Roughing to Heavy Roughing
DOMX (L1)	DOMX (R1)
	
(15)	(15)

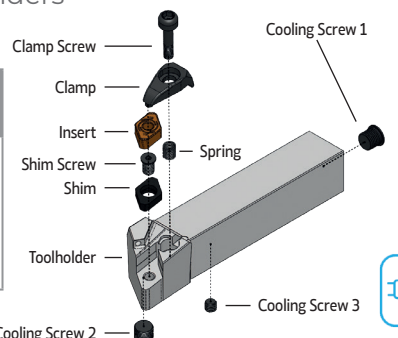

Labels: Clamp Screw, Clamp, Insert, Shim Screw, Shim, Toolholder, Spring, Cooling Screw 1, Cooling Screw 2, Cooling Screw 3

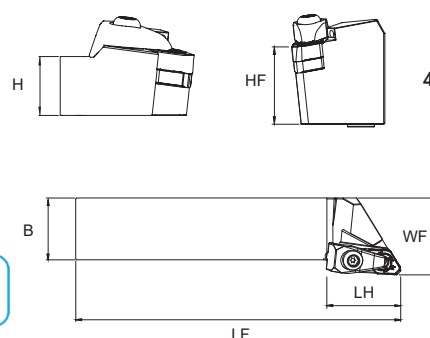



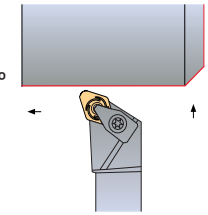



Labels: H, HF, B, LF, LH, WF



45°











Axial: -6,25°
Radial: -6,75°

Order Code		Reference Referência Referencia	Dimensions Dimensões Dimensiones (mm)					Insert Pastilha Inserto	WT	Stock	
R	L		HF = H	B	LF	LH	WF			R	L
182000900	182001200	DDJN R/L 2020 K15-A-DX1	20	20	125	42	25	DOMX 1506..	0,40		
182001000	182001300	DDJN R/L 2525 M15-A-DX1	25	25	150	42	32	DOMX 1506..	0,75		
182001100	182001400	DDJN R/L 3232 P15-A-DX1	32	32	170	42	40	DOMX 1506..	1,30		

 Stock item | Produto de stock | Itens de stock

 Available under request | Disponível sobre consulta | Disponible bajo consulta







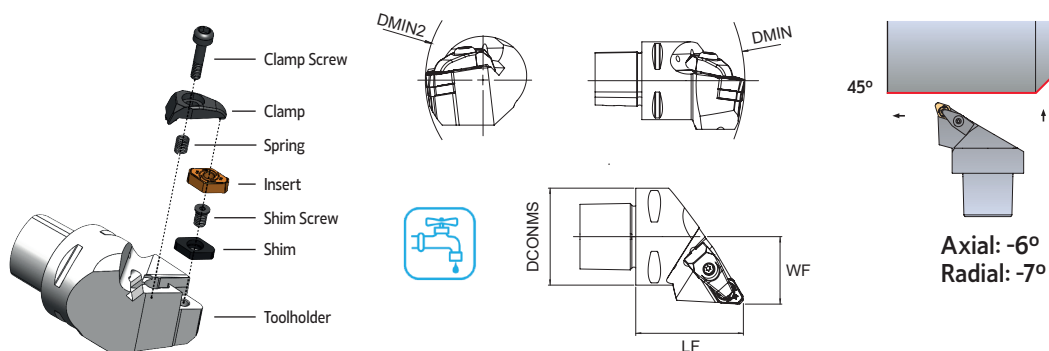
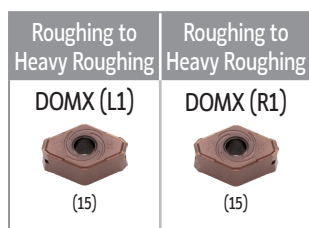

SPARE PARTS Acessórios | Repuestos

Cutter Reference	Shim R	Shim L	Shim Screw	Spring	Clamp	Clamp Screw	Wrench	Coolant Screw 1	Coolant Screw 2	Coolant Screw 3
DDJN R/L 2020 K15-A-DX1										
DDJN R/L 2525 M15-A-DX1	CD150503	CD150502	T06010000	M09513	GA07002	D0602900	SS40	H0600475	H1000875	T1000875
DDJN R/L 3232 P15-A-DX1	CD150503	CD150502	T06010000	M09513	GA07002	D0602900	SS40	-	H1000875	-

A - DDJN-DX1 45° Toolholders

(D) Dimple lock toolholders







Order Code		Reference Referência Referencia	Dimensions (mm)					Insert Pastilha Inserto	WT	Stock	
R	L		DCONMS	DMIN	DMIN2	WF	LF			R	L
182000100	182000500	PSC40-DDJNR/L27055-15-DX1	40	110	145	27	55	DOMX 1506..	0,42		
182000200	182000600	PSC50-DDJNR/L35060-15-DX1	50	110	165	35	60	DOMX 1506..	0,80		
182000300	182000700	PSC63-DDJNR/L45065-15-DX1	63	110	190	45	65	DOMX 1506..	1,10		
182000400	182000800	PSC80-DDJNR/L55080-15-DX1	80	110	250	55	80	DOMX 1506..	2,74		

 Stock item | Produto de stock | Itens de stock

 Available under request | Disponível sobre consulta | Disponible bajo consulta

SPARE PARTS Acessórios | Repuestos

Cutter Reference	Shim R	Shim L	Shim Screw	Spring	Clamp	Clamp Screw	Wrench
PSC40-DDJNR/L27055-15-DX1							
PSC50-DDJNR/L35060-15-DX1	CD150503	CD150502	T06010000	M09513	GA07002	D0602900	SS40
PSC63-DDJNR/L45065-15-DX1	CD150503	CD150502	T06010000	M09513	GA07002	D0602900	SS40
PSC80-DDJNR/L55080-15-DX1	CD150503	CD150502	T06010000	M09513	GA07002	D0602900	SS40



Note: It is possible to adapt your standard toolholder | É possível adaptar um suporte convencional | Puede adaptar un soporte convencional

HEADQUARTERS

PALBIT. S.A.

T (+351) 234 540 300 | F (+351) 234 540 301

palbit@palbit.pt | www.palbit.pt

Branch office

PALBIT México, S de RL de CV

T (+52) 5555 454 543 | F (+52) 5552 509 190

info@palbit.com.mx | www.palbit.pt/mx

Branch office

PALBIT Brasil

T (+55) 011 25 343 648

palbit@palbit.com.br | www.palbit.pt/br

