

Stružne navojne ploščice + držalo BREZPLAČNO

STRUŽENJE NAVOJEV PROMO

NAROČI **20** REZIL

IN PREJMI 1 JEKLENO

DRŽALO BREZPLAČNO

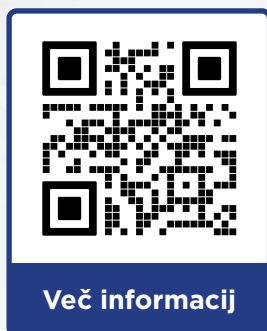
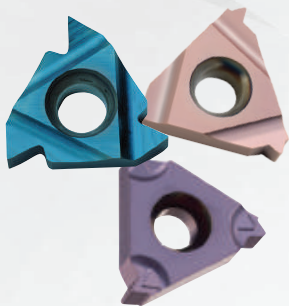

Promocijska ponudba velja v primeru nakupa 20kos enakih rezil ali 10 + 10kos ob pogoju, da so vsa rezila kompatibilna z brezplačnim držalom in velja za vsa standardna rezila velikosti 11 in 16 v oblikah navojev ISO/UN /W/TR razen rezila oblike K, V, Z, U in večzoba rezila. Promocijska ponudba velja za standardno zunanje jekleno držalo SER do 32x32mm, Standardno notranje jekleno držalo SIR do Ø32mm.

XQ ALU – Rezkarji za Aluminij PERFORMANCE Line DP/DH/DF

Za dinamično rezkanje Aluminija:

- Nepravilna geometrija (DP) preprečujejo vibracije in povečujejo produktivnost
- Različni koti vijačnic (DH) zagotavljajo odlično površinsko obdelavo
- Optimiziran premer jedra (DF) omogoča večje pomike
- Notranje hlajenje za visoko produktivnost in stabilno obdelavo
- Poliran rezalni rob in vijačnica
- Trohoidno rezkanje

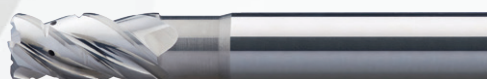

Engineered To Perfection

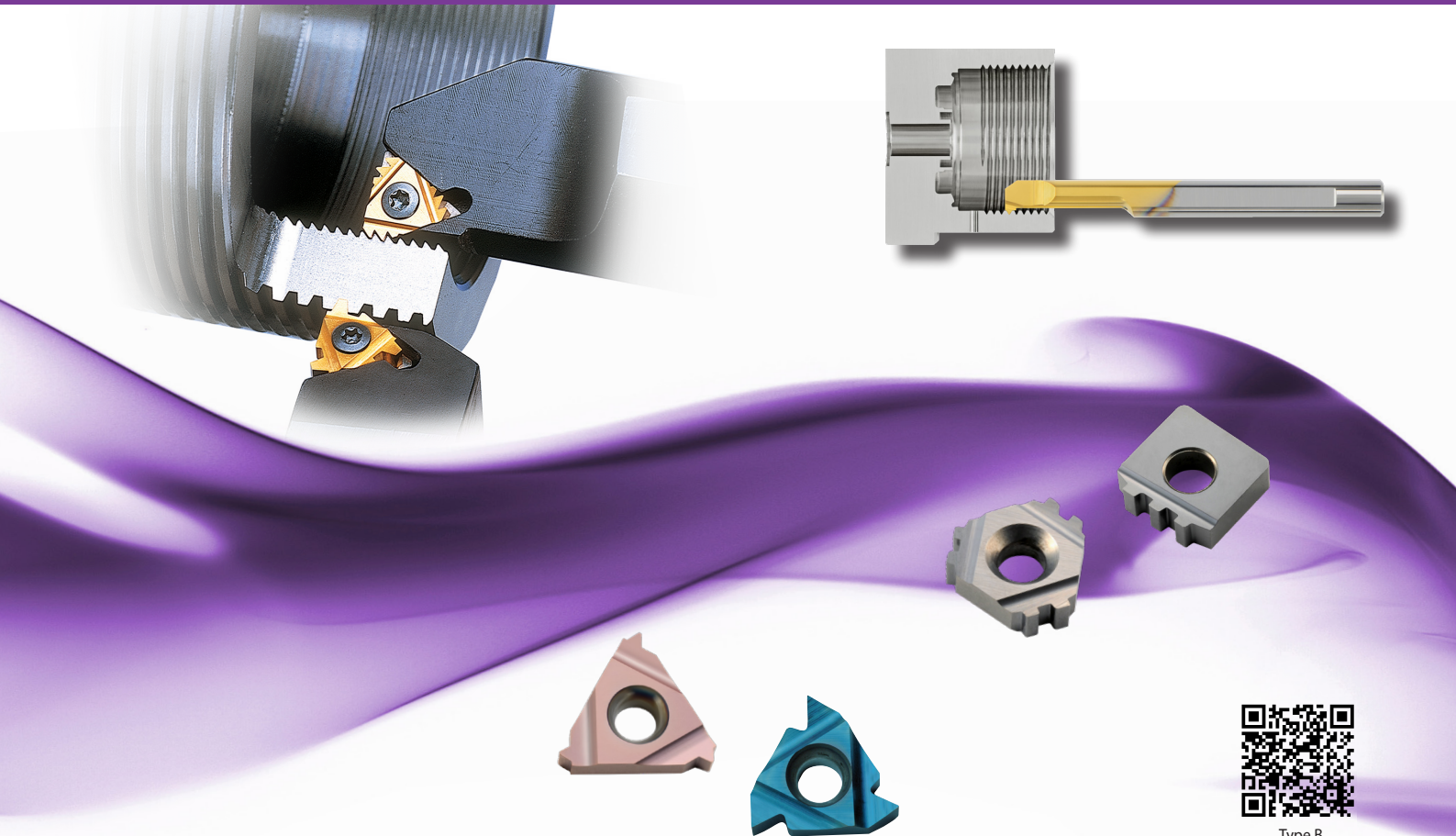

Type B
Demonstration

Contents:	Page:	Contents:	Page:
Product Identification	2	VAM	34
Partial Profile 60°	3-4	HUGHES	35
Partial Profile 55°	5-6	PAC	35
ISO - metric	7-9	NPS	36
UN - Unified	10-13	NPSM	36
Whitworth - 55°	14-17	Vertical API	37
NPT	18-19	Vertical API Buttress Casing	38
NPTF	20	Vertical API Round	39
BSPT	21-22	Chasers API Round	40
DIN 477	22	Chasers API Buttress Casing	41
Acme	23	Chasers OTTM Buttress Casing	41
Stub Acme	24	Chasers API Buttress Casing	42
Trapez - DIN 103	25	Chasers OTTM Buttress Casing	42
PG - DIN 40430	26	Chasers API Buttress Casing	43
Sagengewinde - DIN 513	26	Chasers OTTM Buttress Casing	43
Round - DIN 405	27	Chasers API Buttress Casing	44
Round - DIN 20400	27	Chasers OTTM Buttress Casing	44
UNJ	28-29	Large Profile Inserts and Toolholders	45-50
MJ - ISO 5855	30	Large Profile Inserts Trapez - DIN 103	45
American Buttress	31	External Holders	46
Threading Tools for the Oil & Gas Industries	32-44	Internal Holders	47
API Round	32	Large Profile Sagengewinde Inserts DIN 513	48
V-0.040	33	External Holders	49
V-0.038R	33	Internal Holders	50
V-0.050	33		
V-0.055	33		
Extreme - Line Casing	34		
Buttress Casing	34		

Product Identification

Thread Turning Inserts Ordering Codes

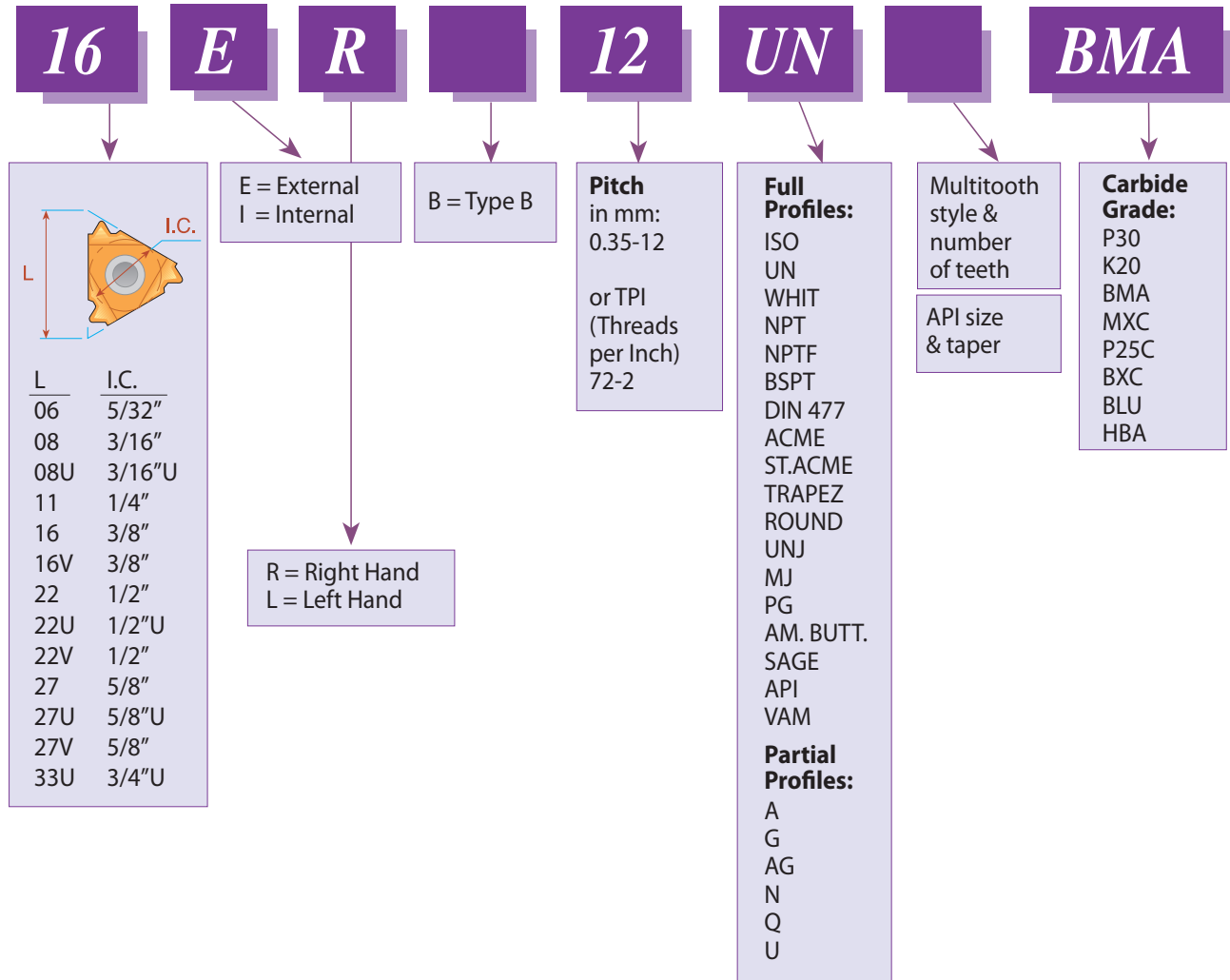

Partial Profile 60°

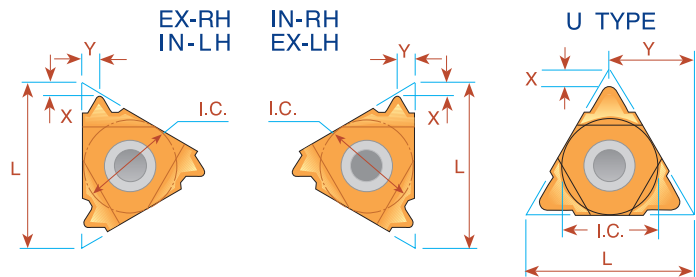
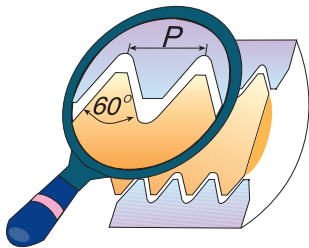

L	I.C. in	Pitch Range		EXTERNAL		INTERNAL		X	Y
		mm	TPI	Ordering Code Right Hand	Ordering Code Left Hand	Ordering Code Right Hand	Ordering Code Left Hand		
6	5/32	0.5 - 1.25	48 - 20	ULTRA MINIATURE →		*06 IR A60	*06 IL A60	0.6	0.6
8	3/16	0.5 - 1.5	48 - 16	MINIATURE →		*08 IR A60	*08 IL A60	0.6	0.7
8U	3/16U	1.75 - 2.0	14 - 11	"U" MINIATURE →		*08U IR/L U60		0.8	4.0
11	1/4	0.5 - 1.5	48 - 16	11 ER A60	11 EL A60	11 IR A60	11 IL A60	0.8	0.9
16	3/8	0.5 - 1.5	48 - 16	16 ER A60	16 EL A60	16 IR A60	16 IL A60	0.8	0.9
16	3/8	1.75 - 3.0	14 - 8	16 ER G60	16 EL G60	16 IR G60	16 IL G60	1.2	1.7
16	3/8	0.5 - 3.0	48 - 8	16 ER AG60	16 EL AG60	16 IR AG60	16 IL AG60	1.2	1.7
22	1/2	3.5 - 5.0	7 - 5	22 ER N60	22 EL N60	22 IR N60	22 IL N60	1.7	2.5
22U	1/2U	5.5 - 8.0	4.5 - 3.25	22U E/R/L U60				0.6	11.0
27	5/8	5.5 - 6.0	4.5 - 4	27 ER Q60	27 EL Q60	27 IR Q60	27 IL Q60	2.1	3.1
27U	5/8U	6.5 - 9.0	4 - 2.75	27U E/R/L U60				1.0	13.7

* Available only in BXC and BMA grades

Order example: 16 ER G60 MXC

For small bore threading see page A06-12

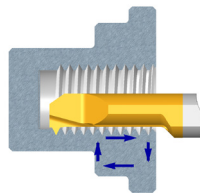

Type B

Ground profile with sintered chip-breaker

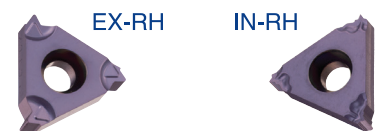

L	I.C. in	Pitch Range		EXTERNAL	INTERNAL	X	Y
		mm	TPI	Ordering Code Right Hand	Ordering Code Right Hand		
16	3/8	0.5 - 1.5	48 - 16	16 ER B A60	16 IR B A60	0.8	0.9
16	3/8	1.75 - 3.0	14 - 8	16 ER B G60	16 IR B G60	1.2	1.7
16	3/8	0.5 - 3.0	48 - 8	16 ER B AG60	16 IR B AG60	1.2	1.7

Order example: 16 ER B G60 BMA

For carbide grade and cutting speed see page A04-2 and 3

Partial Profile 60° Vertical

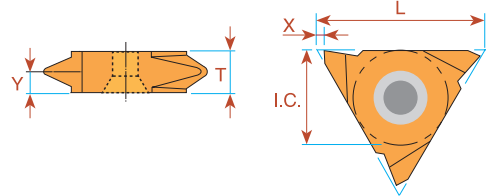

L	I.C. in	Pitch Range		EXTERNAL Ordering Code		INTERNAL Ordering Code		X	Y	T
		mm	TPI	Right Hand	Left Hand	Right Hand	Left Hand			
16	3/8	0.5 - 1.5	48 - 16	16V ER A60	16V EL A60			1.0	0.9	3.6
16	3/8	1.75 - 3.0	14 - 8	16V ER G60	16V EL G60			1.0	1.8	3.6
16	3/8	0.5 - 3.0	48 - 8	16V ER AG60	16V EL AG60			1.0	1.8	3.6
22	1/2	1.75 - 3.0	14 - 8	22V ER G60	22V EL G60			1.2	1.7	4.0
22	1/2	3.5 - 5.0	7 - 5	22V ER N60	22V EL N60			1.2	2.5	4.8
27	5/8	6.0 - 10.0	4 - 2.5	27V ER V60	27V EL V60	27V IR V60	27V IL V60	1.8	5.2	10.4

Order example: 16V ER G60 BMA

Partial Profile 55°

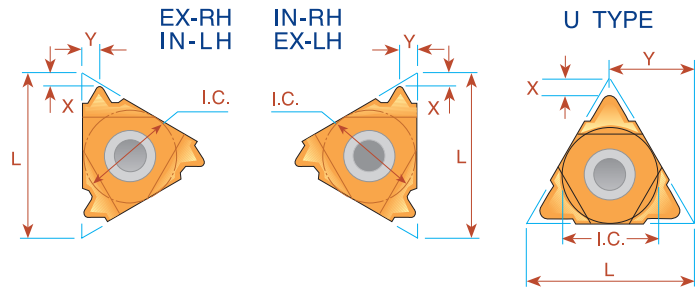
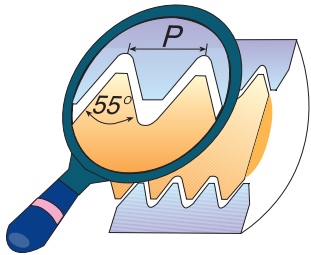

L	I.C. in	Pitch Range		EXTERNAL Ordering Code		INTERNAL Ordering Code		X	Y
		mm	TPI	Right Hand	Left Hand	Right Hand	Left Hand		
6	5/32	0.5 - 1.25	48 - 20	ULTRA MINIATURE →		*06 IR A55	*06 IL A55	0.5	0.6
8	3/16	0.5 - 1.5	48 - 16	MINIATURE →		*08 IR A55	*08 IL A55	0.6	0.7
8U	3/16U	1.75 - 2.0	14 - 11	"U" MINIATURE →		*08U IR/L U55		0.9	4.0
11	1/4	0.5 - 1.5	48 - 16	11 ER A55	11 EL A55	11 IR A55	11 IL A55	0.8	0.9
16	3/8	0.5 - 1.5	48 - 16	16 ER A55	16 EL A55	16 IR A55	16 IL A55	0.8	0.9
16	3/8	1.75 - 3.0	14 - 8	16 ER G55	16 EL G55	16 IR G55	16 IL G55	1.2	1.7
16	3/8	0.5 - 3.0	48 - 8	16 ER AG55	16 EL AG55	16 IR AG55	16 IL AG55	1.2	1.7
22	1/2	3.5 - 5.0	7 - 5	22 ER N55	22 EL N55	22 IR N55	22 IL N55	1.7	2.5
22U	1/2U	5.5 - 8.0	4.5 - 3.25	22U E/R/L U55				0.9	11.0
27	5/8	5.5 - 6.0	4.5 - 4	27 ER Q55	27 EL Q55	27 IR Q55	27 IL Q55	2.0	2.9
27U	5/8U	6.5 - 9.0	4 - 2.75	27U E/R/L U55				1.2	13.7

* Available only in BXC and BMA grades

Order example: 16 ER G55 MXC

For small bore threading see page A06-12

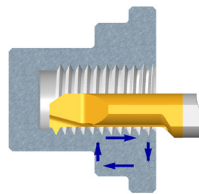

Type B

Ground profile with sintered chip-breaker



L	I.C. in	Pitch Range		EXTERNAL	INTERNAL	X	Y
		mm	TPI	Ordering Code Right Hand	Ordering Code Right Hand		
16	3/8	1.75 - 3.0	14 - 8	16 ER B G55	16 IR B G55	1.2	1.7
16	3/8	0.5 - 3.0	48 - 8	16 ER B AG55	16 IR B AG55	1.2	1.7

Order example: 16 ER B G55 BMA

For carbide grade and cutting speed see page A04-2 and 3

Partial Profile 55° Vertical

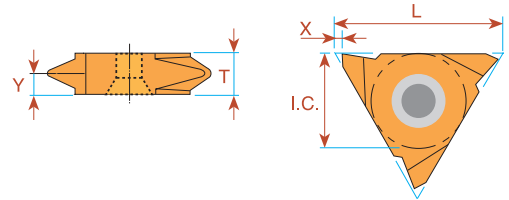

L	I.C. in	Pitch Range		EXTERNAL Ordering Code		INTERNAL Ordering Code		X	Y	T
		mm	TPI	Right Hand	Left Hand	Right Hand	Left Hand			
16	3/8	0.5 - 1.5	48 - 16	16V ER A55	16V EL A55			1.0	0.9	3.6
16	3/8	1.75 - 3.0	14 - 8	16V ER G55	16V EL G55			1.0	1.7	3.6
16	3/8	0.5 - 3.0	48 - 8	16V ER AG55	16V EL AG55			1.0	1.8	3.6
22	1/2	3.5 - 5.0	7 - 5	22V ER N55	22V EL N55			1.2	2.5	4.8
27	5/8	6.0 - 10.0	4 - 2.5	27V ER V55	27V EL V55	27V IR V55	27V IL V55	1.8	5.2	10.4

Order example: 22V ER N55 BMA

Thread Turning Inserts

ISO - metric

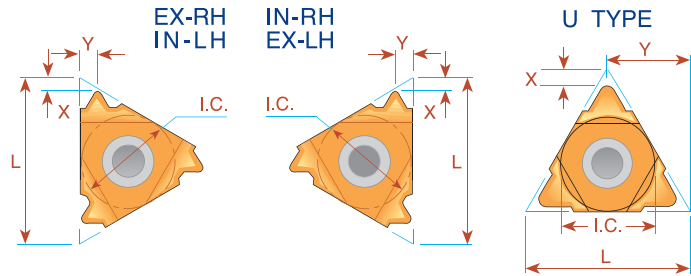
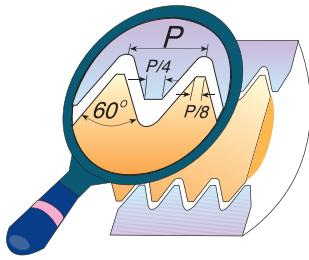

Pitch mm	L	I.C. in	EXTERNAL		X	Y	INTERNAL		X	Y
			Ordering Code Right Hand	Ordering Code Left Hand			Ordering Code Right Hand	Ordering Code Left Hand		
0.25	6	5/32					*06 IR 0.25 ISO	*06 IL 0.25 ISO	0.7	0.3
0.5	6	5/32					*06 IR 0.5 ISO	*06 IL 0.5 ISO	0.9	0.5
0.75	6	5/32	<i>ULTRA MINIATURE</i> →				*06 IR 0.75 ISO	*06 IL 0.75 ISO	0.8	0.5
1.0	6	5/32					*06 IR 1.0 ISO	*06 IL 1.0 ISO	0.7	0.6
1.25	6	5/32					*06 IR 1.25 ISO	*06 IL 1.25 ISO	0.6	0.6
0.25	8	3/16					*08 IR 0.25 ISO	*08 IL 0.25 ISO	0.7	0.3
0.5	8	3/16					*08 IR 0.5 ISO	*08 IL 0.5 ISO	0.6	0.5
0.75	8	3/16	<i>MINIATURE</i> →				*08 IR 0.75 ISO	*08 IL 0.75 ISO	0.6	0.5
1.0	8	3/16					*08 IR 1.0 ISO	*08 IL 1.0 ISO	0.6	0.6
1.25	8	3/16					*08 IR 1.25 ISO	*08 IL 1.25 ISO	0.6	0.7
1.5	8	3/16					*08 IR 1.5 ISO	*08 IL 1.5 ISO	0.6	0.7
1.75	8	3/16					*08 IR 1.75 ISO	*08 IL 1.75 ISO	0.6	0.8
2.0	8U	3/16U	<i>"U" MINIATURE</i> →				*08U IR/L 2.0 ISO		0.9	4.0
0.25	11	1/4	11 ER 0.25 ISO	11 EL 0.25 ISO	0.6	0.2				
0.3	11	1/4	11 ER 0.3 ISO	11 EL 0.3 ISO	0.8	0.3				
0.35	11	1/4	11 ER 0.35 ISO	11 EL 0.35 ISO	0.8	0.4	11 IR 0.35 ISO	11 IL 0.35 ISO	0.8	0.3
0.4	11	1/4	11 ER 0.4 ISO	11 EL 0.4 ISO	0.7	0.4	11 IR 0.4 ISO	11 IL 0.4 ISO	0.8	0.4
0.45	11	1/4	11 ER 0.45 ISO	11 EL 0.45 ISO	0.7	0.4	11 IR 0.45 ISO	11 IL 0.45 ISO	0.8	0.4
0.5	11	1/4	11 ER 0.5 ISO	11 EL 0.5 ISO	0.6	0.6	11 IR 0.5 ISO	11 IL 0.5 ISO	0.6	0.6
0.6	11	1/4	11 ER 0.6 ISO	11 EL 0.6 ISO	0.6	0.6	11 IR 0.6 ISO	11 IL 0.6 ISO	0.6	0.6
0.7	11	1/4	11 ER 0.7 ISO	11 EL 0.7 ISO	0.6	0.6	11 IR 0.7 ISO	11 IL 0.7 ISO	0.6	0.6
0.75	11	1/4	11 ER 0.75 ISO	11 EL 0.75 ISO	0.6	0.6	11 IR 0.75 ISO	11 IL 0.75 ISO	0.6	0.6
0.8	11	1/4	11 ER 0.8 ISO	11 EL 0.8 ISO	0.6	0.6	11 IR 0.8 ISO	11 IL 0.8 ISO	0.6	0.6
1.0	11	1/4	11 ER 1.0 ISO	11 EL 1.0 ISO	0.7	0.7	11 IR 1.0 ISO	11 IL 1.0 ISO	0.6	0.7
1.25	11	1/4	11 ER 1.25 ISO	11 EL 1.25 ISO	0.8	0.9	11 IR 1.25 ISO	11 IL 1.25 ISO	0.8	0.8
1.5	11	1/4	11 ER 1.5 ISO	11 EL 1.5 ISO	0.8	1.0	11 IR 1.5 ISO	11 IL 1.5 ISO	0.8	1.0
1.75	11	1/4	11 ER 1.75 ISO	11 EL 1.75 ISO	0.8	1.1	11 IR 1.75 ISO	11 IL 1.75 ISO	0.8	1.1
2.0	11	1/4	11 ER 2.0 ISO	11 EL 2.0 ISO	0.8	1.1	11 IR 2.0 ISO	11 IL 2.0 ISO	0.8	0.9
2.5	11	1/4					11 IR 2.5 ISO	11 IL 2.5 ISO	0.8	1.2
0.25	16	3/8	16 ER 0.25 ISO	16 EL 0.25 ISO	0.6	0.2				
0.3	16	3/8	16 ER 0.3 ISO	16 EL 0.3 ISO	0.8	0.3				
0.35	16	3/8	16 ER 0.35 ISO	16 EL 0.35 ISO	0.8	0.4	16 IR 0.35 ISO	16 IL 0.35 ISO	0.8	0.3
0.4	16	3/8	16 ER 0.4 ISO	16 EL 0.4 ISO	0.7	0.4	16 IR 0.4 ISO	16 IL 0.4 ISO	0.8	0.4
0.45	16	3/8	16 ER 0.45 ISO	16 EL 0.45 ISO	0.7	0.4	16 IR 0.45 ISO	16 IL 0.45 ISO	0.8	0.4
0.5	16	3/8	16 ER 0.5 ISO	16 EL 0.5 ISO	0.6	0.6	16 IR 0.5 ISO	16 IL 0.5 ISO	0.6	0.6
0.6	16	3/8	16 ER 0.6 ISO	16 EL 0.6 ISO	0.6	0.6	16 IR 0.6 ISO	16 IL 0.6 ISO	0.6	0.6
0.7	16	3/8	16 ER 0.7 ISO	16 EL 0.7 ISO	0.6	0.6	16 IR 0.7 ISO	16 IL 0.7 ISO	0.6	0.6
0.75	16	3/8	16 ER 0.75 ISO	16 EL 0.75 ISO	0.6	0.6	16 IR 0.75 ISO	16 IL 0.75 ISO	0.6	0.6
0.8	16	3/8	16 ER 0.8 ISO	16 EL 0.8 ISO	0.6	0.6	16 IR 0.8 ISO	16 IL 0.8 ISO	0.6	0.6
1.0	16	3/8	16 ER 1.0 ISO	16 EL 1.0 ISO	0.7	0.7	16 IR 1.0 ISO	16 IL 1.0 ISO	0.6	0.7
1.25	16	3/8	16 ER 1.25 ISO	16 EL 1.25 ISO	0.8	0.9	16 IR 1.25 ISO	16 IL 1.25 ISO	0.8	0.9
1.5	16	3/8	16 ER 1.5 ISO	16 EL 1.5 ISO	0.8	1.0	16 IR 1.5 ISO	16 IL 1.5 ISO	0.8	1.0
1.75	16	3/8	16 ER 1.75 ISO	16 EL 1.75 ISO	0.9	1.2	16 IR 1.75 ISO	16 IL 1.75 ISO	0.9	1.2
2.0	16	3/8	16 ER 2.0 ISO	16 EL 2.0 ISO	1.0	1.3	16 IR 2.0 ISO	16 IL 2.0 ISO	1.0	1.3
2.5	16	3/8	16 ER 2.5 ISO	16 EL 2.5 ISO	1.1	1.5	16 IR 2.5 ISO	16 IL 2.5 ISO	1.1	1.5
3.0	16	3/8	16 ER 3.0 ISO	16 EL 3.0 ISO	1.2	1.6	16 IR 3.0 ISO	16 IL 3.0 ISO	1.1	1.5
3.5	16	3/8	16 ER 3.5 ISO	16 EL 3.5 ISO	1.2	1.7	16 IR 3.5 ISO	16 IL 3.5 ISO	1.2	1.7

* Available only in BXC and BMA grades

ISO - metric

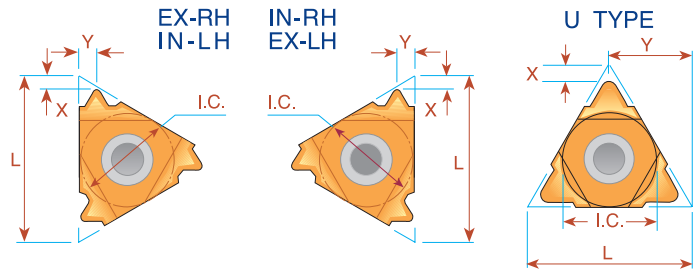
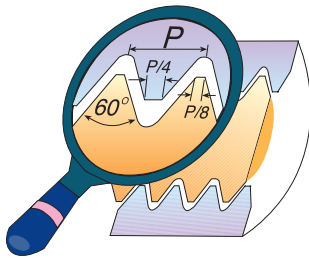

Pitch mm	L	I.C. in	EXTERNAL		X	Y	INTERNAL		X	Y
			Ordering Code Right Hand	Ordering Code Left Hand			Ordering Code Right Hand	Ordering Code Left Hand		
3.5	22	1/2	22 ER 3.5 ISO	22 EL 3.5 ISO	1.6	2.3	22 IR 3.5 ISO	22 IL 3.5 ISO	1.6	2.3
4.0	22	1/2	22 ER 4.0 ISO	22 EL 4.0 ISO	1.6	2.3	22 IR 4.0 ISO	22 IL 4.0 ISO	1.6	2.3
4.5	22	1/2	22 ER 4.5 ISO	22 EL 4.5 ISO	1.7	2.4	22 IR 4.5 ISO	22 IL 4.5 ISO	1.6	2.4
5.0	22	1/2	22 ER 5.0 ISO	22 EL 5.0 ISO	1.7	2.5	22 IR 5.0 ISO	22 IL 5.0 ISO	1.6	2.3
5.5	22	1/2	22 ER 5.5 ISO	22 EL 5.5 ISO	1.7	2.6	22 IR 5.5 ISO	22 IL 5.5 ISO	1.6	2.3
6.0	22	1/2	**22 ER 6.0 ISO	**22 EL 6.0 ISO	1.9	2.7	22 IR 6.0 ISO	22 IL 6.0 ISO	1.6	2.4
5.5	22U	1/2U	22U ER/L 5.5 ISO		2.3	11.0	22U IR/L 5.5 ISO		2.4	11.0
6.0	22U	1/2U	22U ER/L 6.0 ISO		2.6	11.0	22U IR/L 6.0 ISO		2.1	11.0
5.5	27	5/8	27 ER 5.5 ISO	27 EL 5.5 ISO	1.9	2.7	27 IR 5.5 ISO	27 IL 5.5 ISO	1.6	2.3
6.0	27	5/8	27 ER 6.0 ISO	27 EL 6.0 ISO	2.0	2.9	27 IR 6.0 ISO	27 IL 6.0 ISO	1.8	2.5
8.0	27U	5/8U	27U ER/L 8.0 ISO		2.4	13.7	27U IR/L 8.0 ISO		2.4	13.7
12.0	33U	3/4U	33U ER/L 12.0 ISO		2.5	16.5	33U IR/L 12.0 ISO		3.5	16.9

** Special holder required

Order example: 22 IR 3.5 ISO BMA

For small bore threading see page A06-13

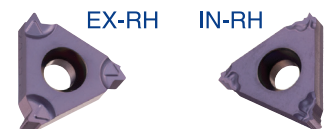
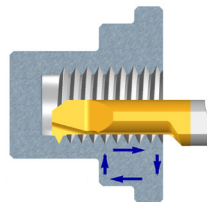

Type B

Ground profile with sintered chip-breaker

Pitch mm	L	I.C. in	EXTERNAL		X	Y	INTERNAL		X	Y
			Ordering Code Right Hand				Ordering Code Right Hand			
0.5	11	1/4					11 IR B 0.5 ISO		0.6	0.6
0.75	11	1/4					11 IR B 0.75 ISO		0.6	0.6
0.8	11	1/4					11 IR B 0.8 ISO		0.6	0.6
1.0	11	1/4					11 IR B 1.0 ISO		0.6	0.6
1.25	11	1/4					11 IR B 1.25 ISO		0.8	0.9
1.5	11	1/4					11 IR B 1.5 ISO		0.8	0.9
1.75	11	1/4					11 IR B 1.75 ISO		0.8	0.9
2.0	11	1/4					11 IR B 2.0 ISO		0.8	0.9
0.8	16	3/8	16 ER B 0.8 ISO		0.6	0.6				
1.0	16	3/8	16 ER B 1.0 ISO		0.7	0.7	16 IR B 1.0 ISO		0.6	0.7
1.25	16	3/8	16 ER B 1.25 ISO		0.8	0.9	16 IR B 1.25 ISO		0.8	0.9
1.5	16	3/8	16 ER B 1.5 ISO		0.8	1.0	16 IR B 1.5 ISO		0.8	1.0
1.75	16	3/8	16 ER B 1.75 ISO		0.9	1.2	16 IR B 1.75 ISO		0.9	1.2
2.0	16	3/8	16 ER B 2.0 ISO		1.0	1.3	16 IR B 2.0 ISO		1.0	1.3
2.5	16	3/8	16 ER B 2.5 ISO		1.1	1.5	16 IR B 2.5 ISO		1.1	1.5
3.0	16	3/8	16 ER B 3.0 ISO		1.2	1.6	16 IR B 3.0 ISO		1.1	1.5

Order example: 16 IR B 1.5 ISO BMA

For carbide grade and cutting speed see page A04-2 and 3

ISO - metric Vertical

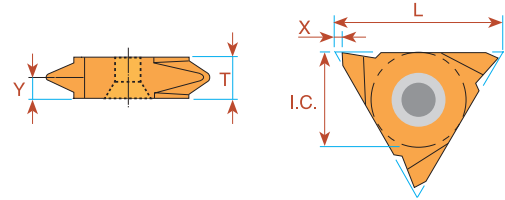

Pitch mm	L	I.C. in	EXTERNAL		INTERNAL		X	Y	T
			Right Hand	Left Hand	Right Hand	Left Hand			
0.5	16	3/8	16V ER 0.5 ISO	16V EL 0.5 ISO			1.0	0.6	3.6
0.75	16	3/8	16V ER 0.75 ISO	16V EL 0.75 ISO			1.0	0.6	3.6
0.8	16	3/8	16V ER 0.8 ISO	16V EL 0.8 ISO			1.0	0.6	3.6
1.0	16	3/8	16V ER 1.0 ISO	16V EL 1.0 ISO			1.0	0.7	3.6
1.25	16	3/8	16V ER 1.25 ISO	16V EL 1.25 ISO			1.0	0.9	3.6
1.5	16	3/8	16V ER 1.5 ISO	16V EL 1.5 ISO			1.0	0.9	3.6
1.75	16	3/8	16V ER 1.75 ISO	16V EL 1.75 ISO			1.0	1.2	3.6
2.0	16	3/8	16V ER 2.0 ISO	16V EL 2.0 ISO			1.0	1.3	3.6
2.5	16	3/8	16V ER 2.5 ISO	16V EL 2.5 ISO			1.0	1.5	3.6
3.0	16	3/8	16V ER 3.0 ISO	16V EL 3.0 ISO			1.0	1.7	3.6
* 8.0	27	5/8	27V ER 8.0 ISO	27V EL 8.0 ISO	27V IR 8.0 ISO	27V IL 8.0 ISO	1.8	5.2	10.4
** 10.0	27	5/8	27V ER 10.0 ISO	27V EL 10.0 ISO	27V IR 10.0 ISO	27V IL 10.0 ISO	1.8	5.2	10.4

Order example: 16V ER 1.5 ISO BMA

* Minimum bore: Ø60 mm

** Minimum bore: Ø72 mm

Multitooth

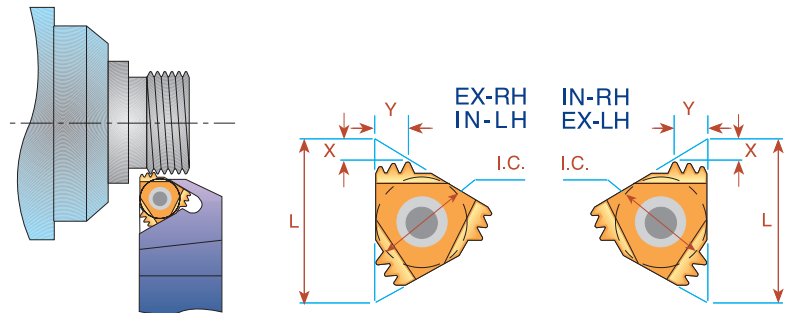

Pitch mm	L	I.C. in	Number of Teeth	EXTERNAL	Anvil	INTERNAL	Anvil	X	Y
				Ordering Code		Ordering Code			
1.0	16	3/8	3	16 ER 1.0 ISO 3M	AE16M	16 IR 1.0 ISO 3M	AI16M	1.7	2.5
1.5	16	3/8	2	16 ER 1.5 ISO 2M	AE16M	16 IR 1.5 ISO 2M	AI16M	1.5	2.3
2.0	16	3/8	2	16 ER 2.0 ISO 2M	AE16M	16 IR 2.0 ISO 2M	AI16M	2.0	3.0
1.5	22	1/2	3	22 ER 1.5 ISO 3M	AE22M	22 IR 1.5 ISO 3M	AI22M	2.3	3.7
2.0	22	1/2	2	22 ER 2.0 ISO 2M	AE22M	22 IR 2.0 ISO 2M	AI22M	2.0	3.0
2.0	22	1/2	3	22 ER 2.0 ISO 3M	AE22M	22 IR 2.0 ISO 3M	AI22M	3.1	5.0
2.5	22	1/2	2	22 ER 2.5 ISO 2M	AE22M	22 IR 2.5 ISO 2M	AI22M	2.4	3.7
2.5	22	1/2	3	22 ER 2.5 ISO 3M	AE22M	22 IR 2.5 ISO 3M	AI22M	3.8	6.2
3.0	27	5/8	2	27 ER 3.0 ISO 2M	AE27M	27 IR 3.0 ISO 2M	AI27M	2.9	4.6

Order example: 22 IR 2.0 ISO 2M BMA

For recommended number of passes see page A04-4

For carbide grade and cutting speed see page A04-2 and 3

UN - Unified UNC, UNF, UNEF, UNS

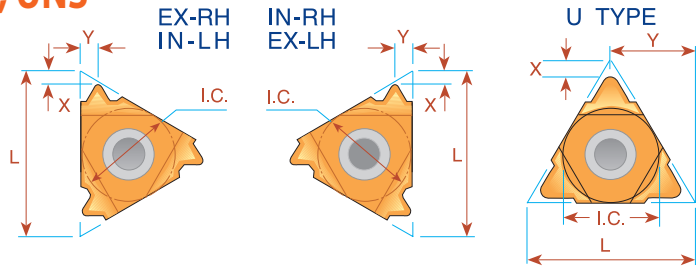
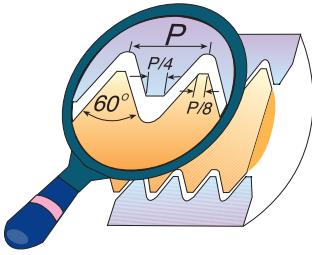

Pitch TPI	L	I.C. in	EXTERNAL		X	Y	INTERNAL		X	Y
			Ordering Code Right Hand	Ordering Code Left Hand			Ordering Code Right Hand	Ordering Code Left Hand		
32	6	5/32	<i>ULTRA MINIATURE</i> →				*06 IR 32 UN	*06 IL 32 UN	0.8	0.5
28	6	5/32					*06 IR 28 UN	*06 IL 28 UN	0.8	0.6
24	6	5/32					*06 IR 24 UN	*06 IL 24 UN	0.7	0.6
20	6	5/32					*06 IR 20 UN	*06 IL 20 UN	0.6	0.6
18	6	5/32					*06 IR 18 UN	*06 IL 18 UN	0.6	0.7
32	8	3/16	<i>MINIATURE</i> →				*08 IR 32 UN	*08 IL 32 UN	0.6	0.5
28	8	3/16					*08 IR 28 UN	*08 IL 28 UN	0.6	0.6
24	8	3/16					*08 IR 24 UN	*08 IL 24 UN	0.6	0.6
20	8	3/16					*08 IR 20 UN	*08 IL 20 UN	0.6	0.7
18	8	3/16					*08 IR 18 UN	*08 IL 18 UN	0.6	0.7
16	8	3/16					*08 IR 16 UN	*08 IL 16 UN	0.6	0.7
14	8	3/16				*08 IR 14 UN	*08 IL 14 UN	0.6	0.8	
13	8	3/16				**08 IR 13 UN		0.8	0.9	
13	8U	3/16U	<i>"U" MINIATURE</i> →				*08U IR/L 13 UN		1.0	4.0
12	8U	3/16U					*08U IR/L 12 UN		0.9	4.0
11	8U	3/16U					*08U IR/L 11 UN		0.9	4.0
80	11	1/4	11 ER 80 UN	11 EL 80 UN	0.8	0.4	11 IR 80 UN	11 IL 80 UN	0.8	0.4
72	11	1/4	11 ER 72 UN	11 EL 72 UN	0.8	0.4	11 IR 72 UN	11 IL 72 UN	0.8	0.3
64	11	1/4	11 ER 64 UN	11 EL 64 UN	0.8	0.4	11 IR 64 UN	11 IL 64 UN	0.8	0.4
56	11	1/4	11 ER 56 UN	11 EL 56 UN	0.7	0.4	11 IR 56 UN	11 IL 56 UN	0.7	0.4
48	11	1/4	11 ER 48 UN	11 EL 48 UN	0.6	0.6	11 IR 48 UN	11 IL 48 UN	0.6	0.6
44	11	1/4	11 ER 44 UN	11 EL 44 UN	0.6	0.6	11 IR 44 UN	11 IL 44 UN	0.6	0.6
40	11	1/4	11 ER 40 UN	11 EL 40 UN	0.6	0.6	11 IR 40 UN	11 IL 40 UN	0.6	0.6
36	11	1/4	11 ER 36 UN	11 EL 36 UN	0.6	0.6	11 IR 36 UN	11 IL 36 UN	0.6	0.6
32	11	1/4	11 ER 32 UN	11 EL 32 UN	0.6	0.6	11 IR 32 UN	11 IL 32 UN	0.6	0.6
28	11	1/4	11 ER 28 UN	11 EL 28 UN	0.6	0.7	11 IR 28 UN	11 IL 28 UN	0.6	0.7
27	11	1/4	11 ER 27 UN	11 EL 27 UN	0.7	0.8	11 IR 27 UN	11 IL 27 UN	0.7	0.8
24	11	1/4	11 ER 24 UN	11 EL 24 UN	0.7	0.8	11 IR 24 UN	11 IL 24 UN	0.7	0.8
20	11	1/4	11 ER 20 UN	11 EL 20 UN	0.8	0.9	11 IR 20 UN	11 IL 20 UN	0.8	0.9
18	11	1/4	11 ER 18 UN	11 EL 18 UN	0.8	1.0	11 IR 18 UN	11 IL 18 UN	0.8	1.0
16	11	1/4	11 ER 16 UN	11 EL 16 UN	0.9	1.1	11 IR 16 UN	11 IL 16 UN	0.9	1.1
14	11	1/4	11 ER 14 UN	11 EL 14 UN	0.9	1.1	11 IR 14 UN	11 IL 14 UN	0.9	1.1
13	11	1/4					11 IR 13 UN	11 IL 13 UN	0.8	1.0
12	11	1/4					11 IR 12 UN	11 IL 12 UN	0.9	1.1
11	11	1/4					11 IR 11 UN	11 IL 11 UN	0.8	1.1
80	16	3/8	16 ER 80 UN	16 EL 80 UN	0.8	0.4	16 IR 80 UN	16 IL 80 UN	0.8	0.4
72	16	3/8	16 ER 72 UN	16 EL 72 UN	0.8	0.4	16 IR 72 UN	16 IL 72 UN	0.8	0.3
64	16	3/8	16 ER 64 UN	16 EL 64 UN	0.8	0.4	16 IR 64 UN	16 IL 64 UN	0.8	0.4
56	16	3/8	16 ER 56 UN	16 EL 56 UN	0.7	0.4	16 IR 56 UN	16 IL 56 UN	0.7	0.4
48	16	3/8	16 ER 48 UN	16 EL 48 UN	0.6	0.6	16 IR 48 UN	16 IL 48 UN	0.6	0.6
44	16	3/8	16 ER 44 UN	16 EL 44 UN	0.6	0.6	16 IR 44 UN	16 IL 44 UN	0.6	0.6
40	16	3/8	16 ER 40 UN	16 EL 40 UN	0.6	0.6	16 IR 40 UN	16 IL 40 UN	0.6	0.6
36	16	3/8	16 ER 36 UN	16 EL 36 UN	0.6	0.6	16 IR 36 UN	16 IL 36 UN	0.6	0.6

* Available only in BXC and BMA grades

** To be used with Holder SIR 0009 K08 on page A02-10

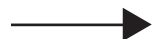

Thread Turning Inserts



UN - Unified **UNC, UNF, UNEF, UNS**

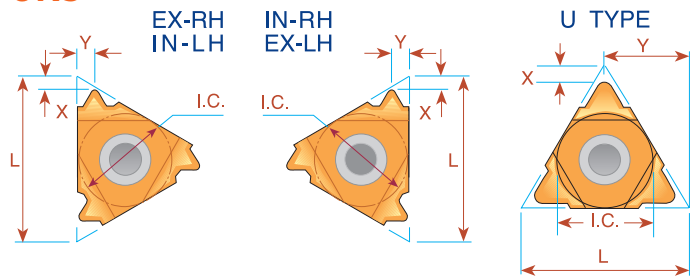
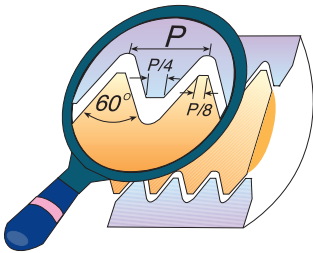

Pitch TPI	L	I.C. in	EXTERNAL				X	Y	INTERNAL				X	Y
			Ordering Code		Right Hand	Left Hand			Ordering Code		Right Hand	Left Hand		
			Right Hand	Left Hand					Right Hand	Left Hand				
32	16	3/8	16 ER 32 UN	16 EL 32 UN	0.6	0.6	16 IR 32 UN	16 IL 32 UN	0.6	0.6				
28	16	3/8	16 ER 28 UN	16 EL 28 UN	0.6	0.7	16 IR 28 UN	16 IL 28 UN	0.6	0.7				
27	16	3/8	16 ER 27 UN	16 EL 27 UN	0.7	0.8	16 IR 27 UN	16 IL 27 UN	0.7	0.8				
24	16	3/8	16 ER 24 UN	16 EL 24 UN	0.7	0.8	16 IR 24 UN	16 IL 24 UN	0.7	0.8				
20	16	3/8	16 ER 20 UN	16 EL 20 UN	0.8	0.9	16 IR 20 UN	16 IL 20 UN	0.8	0.9				
18	16	3/8	16 ER 18 UN	16 EL 18 UN	0.8	1.0	16 IR 18 UN	16 IL 18 UN	0.8	1.0				
16	16	3/8	16 ER 16 UN	16 EL 16 UN	0.9	1.1	16 IR 16 UN	16 IL 16 UN	0.9	1.1				
14	16	3/8	16 ER 14 UN	16 EL 14 UN	1.0	1.2	16 IR 14 UN	16 IL 14 UN	0.9	1.2				
13	16	3/8	16 ER 13 UN	16 EL 13 UN	1.0	1.3	16 IR 13 UN	16 IL 13 UN	1.0	1.3				
12	16	3/8	16 ER 12 UN	16 EL 12 UN	1.1	1.4	16 IR 12 UN	16 IL 12 UN	1.1	1.4				
11.5	16	3/8	16 ER 11.5 UN	16 EL 11.5 UN	1.1	1.5	16 IR 11.5 UN	16 IL 11.5 UN	1.1	1.5				
11	16	3/8	16 ER 11 UN	16 EL 11 UN	1.1	1.5	16 IR 11 UN	16 IL 11 UN	1.1	1.5				
10	16	3/8	16 ER 10 UN	16 EL 10 UN	1.1	1.5	16 IR 10 UN	16 IL 10 UN	1.1	1.5				
9	16	3/8	16 ER 9 UN	16 EL 9 UN	1.2	1.7	16 IR 9 UN	16 IL 9 UN	1.2	1.7				
8	16	3/8	16 ER 8 UN	16 EL 8 UN	1.2	1.6	16 IR 8 UN	16 IL 8 UN	1.1	1.5				
7	22	1/2	22 ER 7 UN	22 EL 7 UN	1.6	2.3	22 IR 7 UN	22 IL 7 UN	1.6	2.3				
6	22	1/2	22 ER 6 UN	22 EL 6 UN	1.6	2.3	22 IR 6 UN	22 IL 6 UN	1.6	2.3				
5	22	1/2	22 ER 5 UN	22 EL 5 UN	1.7	2.5	22 IR 5 UN	22 IL 5 UN	1.6	2.3				
4.5	22U	1/2U	22U ER/L 4.5 UN		2.0	11.0	22U IR/L 4.5 UN		2.4	11.0				
4	22U	1/2U	22U ER/L 4 UN		2.0	11.0	22U IR/L 4 UN		2.4	11.0				
4.5	27	5/8	27 ER 4.5 UN	27 EL 4.5 UN	1.9	2.7	27 IR 4.5 UN	27 IL 4.5 UN	1.7	2.4				
4	27	5/8	27 ER 4 UN	27 EL 4 UN	2.1	3.0	27 IR 4 UN	27 IL 4 UN	1.8	2.7				
3	27U	5/8U	27U ER/L 3 UN		2.5	13.7	27U IR/L 3 UN		2.7	13.7				
2	33U	3/4U	33U ER/L 2 UN		2.8	16.5	33U IR/L 2 UN		3.6	16.9				

Order example: 22 ER 7 UN BMA

For small bore threading see page A06-13

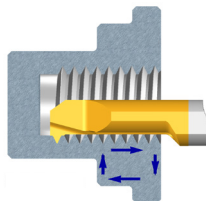

For carbide grade and cutting speed see page A04-2 and 3

UN - Unified Vertical

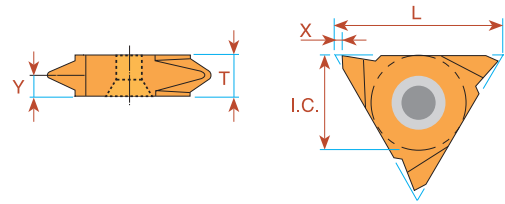

Pitch TPI	L	I.C. in	EXTERNAL		INTERNAL		X	Y	T
			Ordering Code Right Hand	Ordering Code Left Hand	Ordering Code Right Hand	Ordering Code Left Hand			
32	16	3/8	16V ER 32 UN	16V EL 32 UN			1.0	0.6	3.6
28	16	3/8	16V ER 28 UN	16V EL 28 UN			1.0	0.7	3.6
24	16	3/8	16V ER 24 UN	16V EL 24 UN			1.0	0.8	3.6
20	16	3/8	16V ER 20 UN	16V EL 20 UN			1.0	0.9	3.6
18	16	3/8	16V ER 18 UN	16V EL 18 UN			1.0	1.0	3.6
16	16	3/8	16V ER 16 UN	16V EL 16 UN			1.0	1.1	3.6
14	16	3/8	16V ER 14 UN	16V EL 14 UN			1.0	1.2	3.6
12	16	3/8	16V ER 12 UN	16V EL 12 UN			1.0	1.4	3.6
10	16	3/8	16V ER 10 UN	16V EL 10 UN			1.0	1.5	3.6
8	16	3/8	16V ER 8 UN	16V EL 8 UN			1.0	1.6	3.6
7	22	1/2	22V ER 7 UN	22V EL 7 UN			1.2	2.3	4.8
* 3	27	5/8	27V ER 3 UN	27V EL 3 UN	27V IR 3 UN	27V IL 3 UN	1.8	5.2	10.4

* Minimum bore: Ø65 mm

Order example: 22V ER 7 UN MXC

UN - Unified Type B UNC, UNF, UNEF, UNS

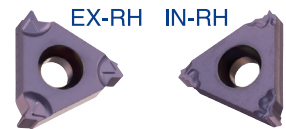

Ground profile with sintered chip-breaker

Pitch TPI	L	I.C. in	EXTERNAL		X	Y	INTERNAL		X	Y
			Ordering Code Right Hand				Ordering Code Right Hand			
32	11	1/4					11 IR B 32 UN	0.6	0.6	
28	11	1/4					11 IR B 28 UN	0.6	0.6	
24	11	1/4					11 IR B 24 UN	0.6	0.6	
20	11	1/4					11 IR B 20 UN	0.8	0.9	
18	11	1/4					11 IR B 18 UN	0.8	0.9	
16	11	1/4					11 IR B 16 UN	0.8	0.9	
14	11	1/4					11 IR B 14 UN	0.8	0.9	
12	11	1/4					11 IR B 12 UN	0.8	0.9	
24	16	3/8	16 ER B 24 UN		0.7	0.8	16 IR B 24 UN	0.7	0.8	
20	16	3/8	16 ER B 20 UN		0.8	0.9	16 IR B 20 UN	0.8	0.9	
18	16	3/8	16 ER B 18 UN		0.8	1.0	16 IR B 18 UN	0.8	1.0	
16	16	3/8	16 ER B 16 UN		0.9	1.1	16 IR B 16 UN	0.9	1.1	
14	16	3/8	16 ER B 14 UN		1.0	1.2	16 IR B 14 UN	0.9	1.2	
13	16	3/8	16 ER B 13 UN		1.0	1.3				
12	16	3/8	16 ER B 12 UN		1.1	1.4	16 IR B 12 UN	1.1	1.4	
11	16	3/8	16 ER B 11 UN		1.1	1.5				
10	16	3/8	16 ER B 10 UN		1.1	1.5	16 IR B 10 UN	1.1	1.5	
9	16	3/8	16 ER B 9 UN		1.2	1.7				
8	16	3/8	16 ER B 8 UN		1.2	1.6	16 IR B 8 UN	1.1	1.1	

Order example: 16 IR B 12 UN BMA

Multitooth

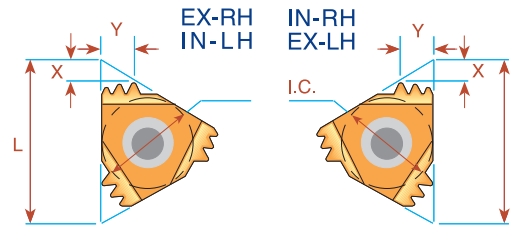
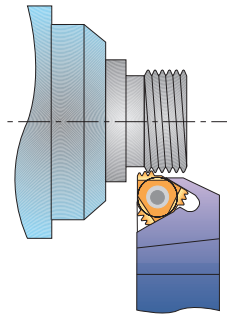

Pitch TPI	L	I.C. in	Number of Teeth	EXTERNAL	Anvil	INTERNAL	Anvil	X	Y
				Ordering Code		Ordering Code			
24	16	3/8	2	16 ER 24 UN 2M	AE16M	16 IR 24 UN 2M	AI16M	1.1	1.7
20	16	3/8	2	16 ER 20 UN 2M	AE16M	16 IR 20 UN 2M	AI16M	1.4	2.0
18	16	3/8	2	16 ER 18 UN 2M	AE16M	16 IR 18 UN 2M	AI16M	1.5	2.2
16	16	3/8	2	16 ER 16 UN 2M	AE16M	16 IR 16 UN 2M	AI16M	1.5	2.3
14	16	3/8	2	16 ER 14 UN 2M	AE16M	16 IR 14 UN 2M	AI16M	1.7	2.7
12	16	3/8	2	16 ER 12 UN 2M	AE16M	16 IR 12 UN 2M	AI16M	2.0	3.1
16	22	1/2	3	22 ER 16 UN 3M	AE22M	22 IR 16 UN 3M	AI22M	2.5	4.0
13	22	1/2	3	22 ER 13 UN 3M	AE22M	-		3.0	4.9
12	22	1/2	2	22 ER 12 UN 2M	AE22M	22 IR 12 UN 2M	AI22M	2.2	3.4
12	22	1/2	3	22 ER 12 UN 3M	AE22M	22 IR 12 UN 3M	AI22M	3.3	5.3
8	27	5/8	2	27 ER 8 UN 2M	AE27M	27 IR 8 UN 2M	AI27M	3.1	4.9

Order example: 22 IR 16 UN 3M BMA

For recommended number of passes see page A04-4

Whitworth - 55° BSW, BSF, BSP, BSB

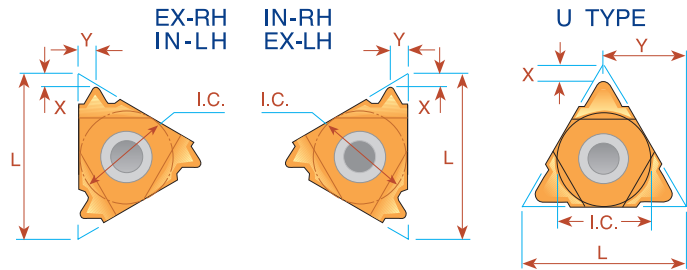
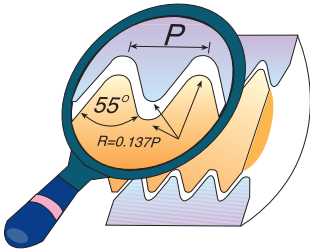

Pitch TPI	L	I.C. in	EXTERNAL		INTERNAL		X	Y
			Ordering Code Right Hand	Ordering Code Left Hand	Ordering Code Right Hand	Ordering Code Left Hand		
26	6	5/32	<i>ULTRA MINIATURE</i> →		*06 IR 26 W	*06 IL 26 W	0.7	0.6
22	6	5/32			*06 IR 22 W	*06 IL 22 W	0.6	0.6
20	6	5/32			*06 IR 20 W	*06 IL 20 W	0.6	0.7
18	6	5/32			*06 IR 18 W	*06 IL 18 W	0.6	0.7
28	8	3/16	<i>MINIATURE</i> →		*08 IR 28 W	*08 IL 28 W	0.6	0.6
24	8	3/16			*08 IR 24 W	*08 IL 24 W	0.6	0.6
20	8	3/16			*08 IR 20 W	*08 IL 20 W	0.6	0.7
19	8	3/16			*08 IR 19 W	*08 IL 19 W	0.6	0.7
18	8	3/16			*08 IR 18 W	*08 IL 18 W	0.6	0.7
16	8	3/16			*08 IR 16 W	*08 IL 16 W	0.6	0.7
14	8U	3/16U	<i>"U" MINIATURE</i> →		*08U IR/L 14 W		1.0	4.0
12	8U	3/16U			*08U IR/L 12 W		0.9	4.0
11	8U	3/16U			*08U IR/L 11 W		0.9	4.0
72	11	1/4	11 ER 72 W	11 EL 72 W	11 IR 72 W	11 IL 72 W	0.7	0.4
60	11	1/4	11 ER 60 W	11 EL 60 W	11 IR 60 W	11 IL 60 W	0.7	0.4
56	11	1/4	11 ER 56 W	11 EL 56 W	11 IR 56 W	11 IL 56 W	0.7	0.4
48	11	1/4	11 ER 48 W	11 EL 48 W	11 IR 48 W	11 IL 48 W	0.6	0.6
40	11	1/4	11 ER 40 W	11 EL 40 W	11 IR 40 W	11 IL 40 W	0.6	0.6
36	11	1/4	11 ER 36 W	11 EL 36 W	11 IR 36 W	11 IL 36 W	0.6	0.6
32	11	1/4	11 ER 32 W	11 EL 32 W	11 IR 32 W	11 IL 32 W	0.6	0.6
28	11	1/4	11 ER 28 W	11 EL 28 W	11 IR 28 W	11 IL 28 W	0.6	0.7
26	11	1/4	11 ER 26 W	11 EL 26 W	11 IR 26 W	11 IL 26 W	0.7	0.7
24	11	1/4	11 ER 24 W	11 EL 24 W	11 IR 24 W	11 IL 24 W	0.7	0.8
22	11	1/4	11 ER 22 W	11 EL 22 W	11 IR 22 W	11 IL 22 W	0.8	0.9
20	11	1/4	11 ER 20 W	11 EL 20 W	11 IR 20 W	11 IL 20 W	0.8	0.9
19	11	1/4	11 ER 19 W	11 EL 19 W	11 IR 19 W	11 IL 19 W	0.8	1.0
18	11	1/4	11 ER 18 W	11 EL 18 W	11 IR 18 W	11 IL 18 W	0.8	1.0
16	11	1/4	11 ER 16 W	11 EL 16 W	11 IR 16 W	11 IL 16 W	0.9	1.1
14	11	1/4	11 ER 14 W	11 EL 14 W	11 IR 14 W	11 IL 14 W	0.9	1.1
12	11	1/4			11 IR 12 W	11 IL 12 W	0.1	1.1
11	11	1/4			⁽¹⁾ 11 IR 11 W	⁽¹⁾ 11 IL 11 W	0.9	1.2
72	16	3/8	16 ER 72 W	16 EL 72 W	16 IR 72 W	16 IL 72 W	0.7	0.4
60	16	3/8	16 ER 60 W	16 EL 60 W	16 IR 60 W	16 IL 60 W	0.7	0.4
56	16	3/8	16 ER 56 W	16 EL 56 W	16 IR 56 W	16 IL 56 W	0.7	0.4
48	16	3/8	16 ER 48 W	16 EL 48 W	16 IR 48 W	16 IL 48 W	0.6	0.6
40	16	3/8	16 ER 40 W	16 EL 40 W	16 IR 40 W	16 IL 40 W	0.6	0.6
36	16	3/8	16 ER 36 W	16 EL 36 W	16 IR 36 W	16 IL 36 W	0.6	0.6
32	16	3/8	16 ER 32 W	16 EL 32 W	16 IR 32 W	16 IL 32 W	0.6	0.6
28	16	3/8	16 ER 28 W	16 EL 28 W	16 IR 28 W	16 IL 28 W	0.6	0.7
26	16	3/8	16 ER 26 W	16 EL 26 W	16 IR 26 W	16 IL 26 W	0.7	0.7
24	16	3/8	16 ER 24 W	16 EL 24 W	16 IR 24 W	16 IL 24 W	0.7	0.8

* Available only in BXC and BMA grades

(1) Special holder is required or standard holder can be amended by customer.



Whitworth - 55° BSW, BSF, BSP, BSB

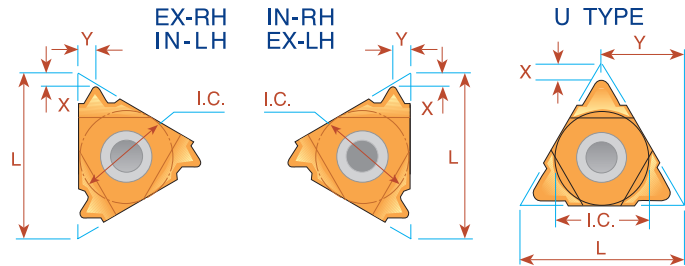
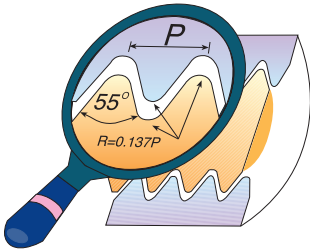

Pitch TPI	L	I.C. in	EXTERNAL		INTERNAL		X	Y
			Right Hand	Left Hand	Right Hand	Left Hand		
22	16	3/8	16 ER 22 W	16 EL 22 W	16 IR 22 W	16 IL 22 W	0.8	0.9
20	16	3/8	16 ER 20 W	16 EL 20 W	16 IR 20 W	16 IL 20 W	0.8	0.9
19	16	3/8	16 ER 19 W	16 EL 19 W	16 IR 19 W	16 IL 19 W	0.8	1.0
18	16	3/8	16 ER 18 W	16 EL 18 W	16 IR 18 W	16 IL 18 W	0.8	1.0
16	16	3/8	16 ER 16 W	16 EL 16 W	16 IR 16 W	16 IL 16 W	0.9	1.1
14	16	3/8	16 ER 14 W	16 EL 14 W	16 IR 14 W	16 IL 14 W	1.0	1.2
12	16	3/8	16 ER 12 W	16 EL 12 W	16 IR 12 W	16 IL 12 W	1.1	1.4
11	16	3/8	16 ER 11 W	16 EL 11 W	16 IR 11 W	16 IL 11 W	1.1	1.5
10	16	3/8	16 ER 10 W	16 EL 10 W	16 IR 10 W	16 IL 10 W	1.1	1.5
9	16	3/8	16 ER 9 W	16 EL 9 W	16 IR 9 W	16 IL 9 W	1.2	1.7
8	16	3/8	16 ER 8 W	16 EL 8 W	16 IR 8 W	16 IL 8 W	1.2	1.5
7	22	1/2	22 ER 7 W	22 EL 7 W	22 IR 7 W	22 IL 7 W	1.6	2.3
6	22	1/2	22 ER 6 W	22 EL 6 W	22 IR 6 W	22 IL 6 W	1.6	2.3
5	22	1/2	22 ER 5 W	22 EL 5 W	22 IR 5 W	22 IL 5 W	1.7	2.4
4.5	22U	1/2U	22U E//R/L 4.5 W				2.3	11.0
4	22U	1/2U	22U E//R/L 4 W				2.8	11.0
4.5	27	5/8	27 ER 4.5 W	27 EL 4.5 W	27 IR 4.5 W	27 IL 4.5 W	1.8	2.6
4	27	5/8	27 ER 4 W	27 EL 4 W	27 IR 4 W	27 IL 4 W	2.0	2.9
3.5	27U	5/8U	27U E//R/L 3.5 W				2.1	13.7
3.25	27U	5/8U	27U E//R/L 3.25 W				2.0	13.7
3	27U	5/8U	27U E//R/L 3 W				2.3	13.7
2.75	27U	5/8U	27U E//R/L 2.75 W				2.4	13.7
*2.625	27U	5/8U	27U E//R/L 2.625 W				2.5	13.7
*2.5	27U	5/8U	27U E//R/L 2.5 W				2.8	13.7

* One cutting edge

Order example: 16 IR 18 W BMA

Whitworth - 55° BSW, BSF, BSP, BSB

Type B

Ground profile with sintered chip-breaker

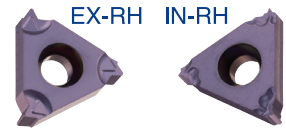

Pitch TPI	L	I.C. in	EXTERNAL	INTERNAL	X	Y
			Ordering Code Right Hand	Ordering Code Right Hand		
28	11	1/4		11 IR B 28 W	0.6	0.6
24	11	1/4		11 IR B 24 W	0.6	0.6
20	11	1/4		11 IR B 20 W	0.8	0.9
19	11	1/4		11 IR B 19 W	0.8	0.9
18	11	1/4		11 IR B 18 W	0.8	0.9
16	11	1/4		11 IR B 16 W	0.8	0.9
14	11	1/4		11 IR B 14 W	0.8	0.9
19	16	3/8	16 ER B 19 W	16 IR B 19 W	0.8	1.0
16	16	3/8	16 ER B 16 W	16 IR B 16 W	0.9	1.1
14	16	3/8	16 ER B 14 W	16 IR B 14 W	1.0	1.2
11	16	3/8	16 ER B 11 W	16 IR B 11 W	1.1	1.5
10	16	3/8	16 ER B 10 W	16 IR B 10 W	1.1	1.5

Order example: 16 IR B 10 W BMA

Vertical

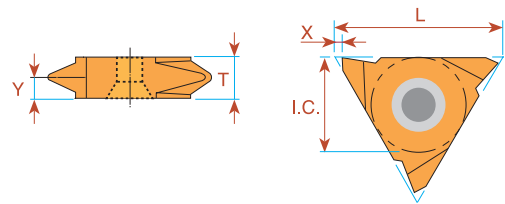

Pitch TPI	L	I.C. in	EXTERNAL	EXTERNAL	X	Y	T
			Ordering Code Right Hand	Ordering Code Left Hand			
20	16	3/8	16V ER 20 W	16V EL 20 W	1.0	0.9	3.6
19	16	3/8	16V ER 19 W	16V EL 19 W	1.0	0.9	3.6
18	16	3/8	16V ER 18 W	16V EL 18 W	1.0	1.0	3.6
16	16	3/8	16V ER 16 W	16V EL 16 W	1.0	1.0	3.6
14	16	3/8	16V ER 14 W	16V EL 14 W	1.0	1.2	3.6
12	16	3/8	16V ER 12 W	16V EL 12 W	1.0	1.4	3.6
11	16	3/8	16V ER 11 W	16V EL 11 W	1.0	1.5	3.6

Order example: 16V ER 14 W MXC

Multitooth

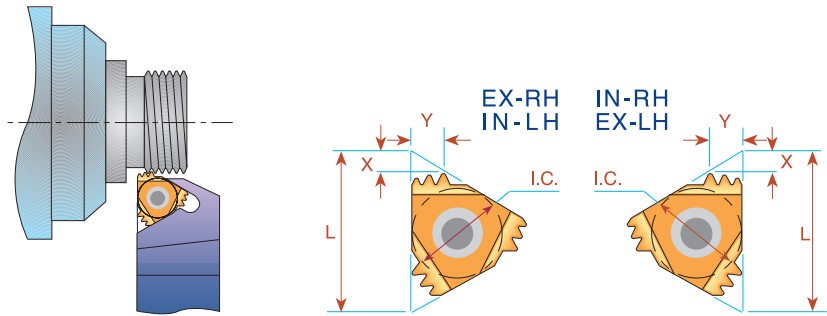

Pitch TPI	L	I.C. in	Number of Teeth	EXTERNAL		INTERNAL		X	Y
				Ordering Code	Anvil	Ordering Code	Anvil		
14	16	3/8	2	16 ER 14 W 2M	AE16M	16 IR 14 W 2M	AI16M	1.7	2.7
11	16	3/8	2	16 ER 11 W 2M	AE16M	16 IR 11 W 2M	AI16M	2.1	3.4
14	22	1/2	3	22 ER 14 W 3M	AE22M	22 IR 14 W 3M	AI22M	2.8	4.5
11	22	1/2	2	22 ER 11 W 2M	AE22M	22 IR 11 W 2M	AI22M	2.1	3.4

Order example: 16 ER 14 W 2M MXC

For recommended number of passes see page A04-4

NPT

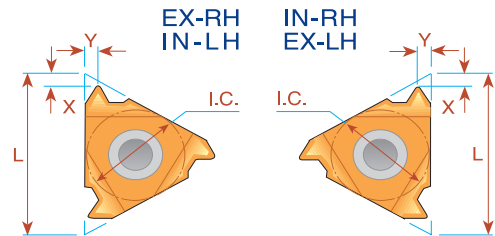
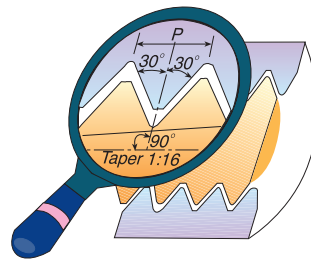

Pitch TPI	L	I.C. in	EXTERNAL		INTERNAL		X	Y
			Ordering Code Right Hand	Ordering Code Left Hand	Ordering Code Right Hand	Ordering Code Left Hand		
27	6	5/32	<i>ULTRA MINIATURE</i> →		*06 IR 27 NPT	*06 IL 27 NPT	0.6	0.6
27	8	3/16			*08 IR 27 NPT	*08 IL 27 NPT	0.6	0.6
18	8	3/16	<i>MINIATURE</i> →		*08 IR 18 NPT	*08 IL 18 NPT	0.6	0.6
27	11	1/4	11 ER 27 NPT	11 EL 27 NPT	11 IR 27 NPT	11 IL 27 NPT	0.7	0.8
18	11	1/4	11 ER 18 NPT	11 EL 18 NPT	11 IR 18 NPT	11 IL 18 NPT	0.8	1.0
14	11	1/4	11 ER 14 NPT	11 EL 14 NPT	11 IR 14 NPT	11 IL 14 NPT	0.8	1.0
27	16	3/8	16 ER 27 NPT	16 EL 27 NPT	16 IR 27 NPT	16 IL 27 NPT	0.7	0.8
18	16	3/8	16 ER 18 NPT	16 EL 18 NPT	16 IR 18 NPT	16 IL 18 NPT	0.8	1.0
14	16	3/8	16 ER 14 NPT	16 EL 14 NPT	16 IR 14 NPT	16 IL 14 NPT	0.9	1.2
11.5	16	3/8	16 ER 11.5 NPT	16 EL 11.5 NPT	16 IR 11.5 NPT	16 IL 11.5 NPT	1.1	1.5
8	16	3/8	16 ER 8 NPT	16 EL 8 NPT	16 IR 8 NPT	16 IL 8 NPT	1.3	1.8

* Available only in BXC and BMA grades

Order example: 16 ER 14 NPT MXC

For small bore threading see page A06-16

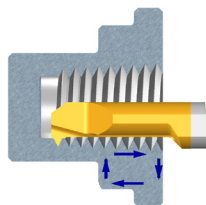

Type B

Ground profile with sintered chip-breaker

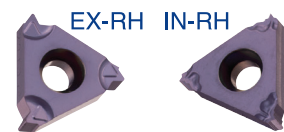

Pitch TPI	L	I.C. in	EXTERNAL		INTERNAL		X	Y
			Ordering Code Right Hand	Ordering Code Right Hand	Ordering Code Right Hand	Ordering Code Right Hand		
18	11	1/4			11 IR B 18 NPT		0.8	0.9
18	16	3/8	16 ER B 18 NPT		16 IR B 18 NPT		0.8	1.0
14	16	3/8	16 ER B 14 NPT		16 IR B 14 NPT		0.9	1.2
11.5	16	3/8	16 ER B 11.5 NPT		16 IR B 11.5 NPT		1.1	1.5
8	16	3/8	16 ER B 8 NPT		16 IR B 8 NPT		1.3	1.8

Order example: 16 IR B 11.5 NPT BMA

For carbide grade and cutting speed see page A04-2 and 3

NPT Multitooth

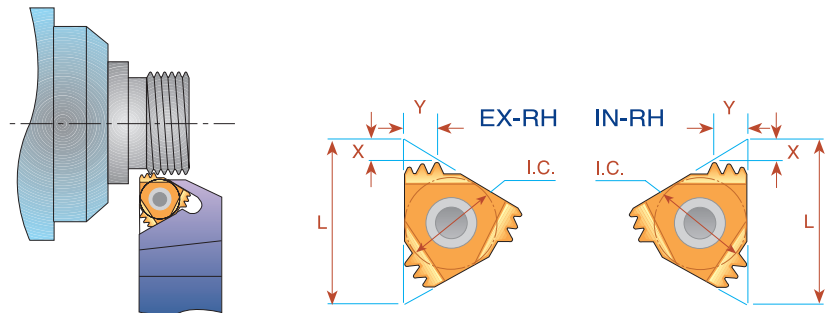

Pitch TPI	L	I.C. in	Number of Teeth	EXTERNAL		Anvil	INTERNAL		Anvil	X	Y
				Ordering Code			Ordering Code				
14	16	3/8	2	16 ER 14 NPT 2M		AE16M	16 IR 14 NPT 2M		AI16M	1.7	2.8
11.5	22	1/2	2	22 ER 11.5 NPT 2M		AE22M	22 IR 11.5 NPT 2M		AI22M	2.3	3.5
11.5	27	5/8	3	27 ER 11.5 NPT 3M		AE27M	27 IR 11.5 NPT 3M		AI27M	3.3	5.5
8	27	5/8	2	27 ER 8 NPT 2M		AE27M	27 IR 8 NPT 2M		AI27M	3.1	5.0

Order example: 22 ER 11.5 NPT 2M MXC

For recommended number of passes see page A04-4

NPT Vertical

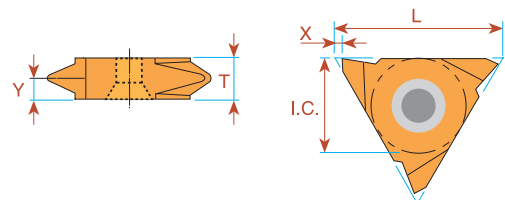

Pitch TPI	L	I.C. in	EXTERNAL		X	Y	T
			Ordering Code Right Hand	Ordering Code Left Hand			
27	16	3/8	16V ER 27 NPT	16V EL 27 NPT	1.0	0.8	3.6
18	16	3/8	16V ER 18 NPT	16V EL 18 NPT	1.0	1.0	3.6
14	16	3/8	16V ER 14 NPT	16V EL 14 NPT	1.0	1.2	3.6
11.5	16	3/8	16V ER 11.5 NPT	16V EL 11.5 NPT	1.0	1.5	3.6

Order example: 16V ER 14 NPT BMA

For carbide grade and cutting speed see page A04-2 and 3

NPTF - Dryseal

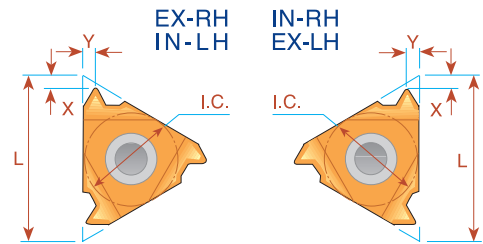
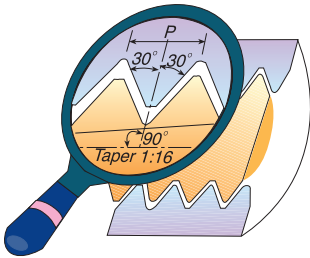

Pitch TPI	L	I.C. in	EXTERNAL		INTERNAL		X	Y
			Ordering Code Right Hand	Ordering Code Left Hand	Ordering Code Right Hand	Ordering Code Left Hand		
27	6	5/32	<i>ULTRA MINIATURE</i> →		*06 IR 27 NPTF	*06 IL 27 NPTF	0.7	0.6
27	8	3/16			*08 IR 27 NPTF	*08 IL 27 NPTF	0.6	0.6
18	8	3/16	<i>MINIATURE</i> →		*08 IR 18 NPTF	*08 IL 18 NPTF	0.6	0.6
27	11	1/4	11 ER 27 NPTF	11 EL 27 NPTF	11 IR 27 NPTF	11 IL 27 NPTF	0.7	0.7
18	11	1/4	11 ER 18 NPTF	11 EL 18 NPTF	11 IR 18 NPTF	11 IL 18 NPTF	0.8	1.0
14	11	1/4	11 ER 14 NPTF	11 EL 14 NPTF	11 IR 14 NPTF	11 IL 14 NPTF	0.8	1.0
27	16	3/8	16 ER 27 NPTF	16 EL 27 NPTF	16 IR 27 NPTF	16 IL 27 NPTF	0.7	0.7
18	16	3/8	16 ER 18 NPTF	16 EL 18 NPTF	16 IR 18 NPTF	16 IL 18 NPTF	0.8	1.0
14	16	3/8	16 ER 14 NPTF	16 EL 14 NPTF	16 IR 14 NPTF	16 IL 14 NPTF	0.9	1.2
11.5	16	3/8	16 ER 11.5 NPTF	16 EL 11.5 NPTF	16 IR 11.5 NPTF	16 IL 11.5 NPTF	1.1	1.5
8	16	3/8	16 ER 8 NPTF	16 EL 8 NPTF	16 IR 8 NPTF	16 IL 8 NPTF	1.3	1.8

* Available only in BXC and BMA grades

Order example: 11 ER 27 NPTF MXC

Type B

Ground profile with sintered chip-breaker

Pitch TPI	L	I.C. in	INTERNAL Ordering Code Right Hand	X	Y
18	11	1/4	11 IR B 18 NPTF	0.8	0.9

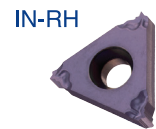

Order example: 11 IR B 18 NPTF BMA

Multitooth

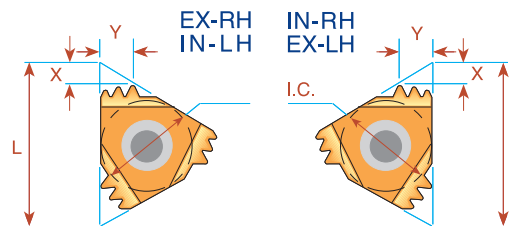
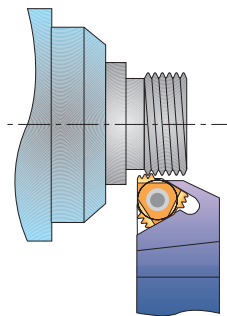

Pitch TPI	L	I.C. in	Number of Teeth	EXTERNAL Ordering Code	Anvil	INTERNAL Ordering Code	Anvil	X	Y
11.5	22	1/2	2	22 ER 11.5 NPTF 2M	AE22M	22 IR 11.5 NPTF 2M	AI22M	2.3	3.5

Order example: 22 ER 11.5 NPTF 2M BMA

For carbide grade and cutting speed see page A04-2 and 3

BSPT

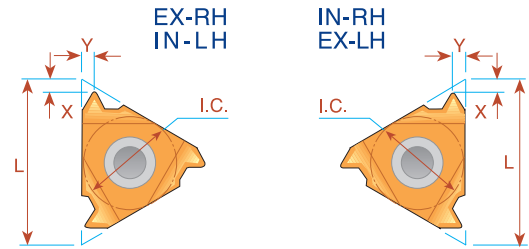
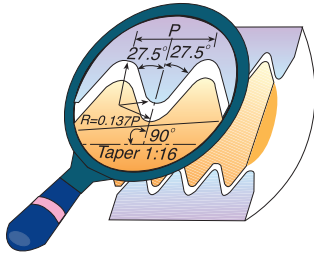

Pitch TPI	L	I.C. in	EXTERNAL		INTERNAL		X	Y
			Ordering Code Right Hand	Ordering Code Left Hand	Ordering Code Right Hand	Ordering Code Left Hand		
28	6	5/32	<i>ULTRA MINIATURE</i> →		*06 IR 28 BSPT	*06 IL 28 BSPT	0.7	0.6
28	8	3/16			*08 IR 28 BSPT	*08 IL 28 BSPT	0.6	0.6
19	8	3/16	<i>MINIATURE</i> →		*08 IR 19 BSPT	*08 IL 19 BSPT	0.6	0.6
28	11	1/4			11 IR 28 BSPT	11 IL 28 BSPT	0.6	0.6
19	11	1/4			11 IR 19 BSPT	11 IL 19 BSPT	0.8	0.9
14	11	1/4			11 IR 14 BSPT	11 IL 14 BSPT	0.9	1.0
11	11	1/4			⁽¹⁾ 11 IR 11 BSPT	⁽¹⁾ 11 IL 11 BSPT	0.9	1.2
28	16	3/8	16 ER 28 BSPT	16 EL 28 BSPT	16 IR 28 BSPT	16 IL 28 BSPT	0.6	0.6
19	16	3/8	16 ER 19 BSPT	16 EL 19 BSPT	16 IR 19 BSPT	16 IL 19 BSPT	0.8	0.9
14	16	3/8	16 ER 14 BSPT	16 EL 14 BSPT	16 IR 14 BSPT	16 IL 14 BSPT	1.0	1.2
11	16	3/8	16 ER 11 BSPT	16 EL 11 BSPT	16 IR 11 BSPT	16 IL 11 BSPT	1.1	1.5

* Available only in BXC and BMA grades

Order example: 11 IR 14 BSPT BMA

(1) Special holder is required or standard holder can be amended by customer.

Type B

Ground profile with sintered chip-breaker

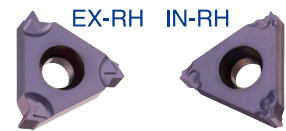

Pitch TPI	L	I.C. in	EXTERNAL		INTERNAL		X	Y
			Ordering Code Right Hand	Ordering Code Right Hand	Ordering Code Right Hand	Ordering Code Right Hand		
19	11	1/4			11 IR B 19 BSPT		0.8	0.9
19	16	3/8	16 ER B 19 BSPT				1.0	1.1
14	16	3/8	16 ER B 14 BSPT		16 IR B 14 BSPT		1.2	1.0
11	16	3/8	16 ER B 11 BSPT		16 IR B 11 BSPT		1.5	1.1

Order example: 16 ER B 11 BSPT BMA

BSPT Vertical

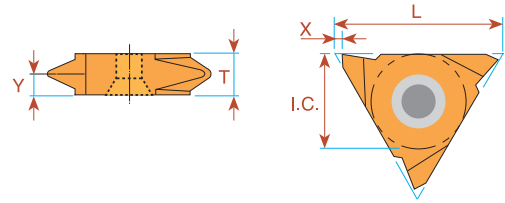

Pitch TPI	L	I.C. in	EXTERNAL	EXTERNAL	X	Y	T
			Ordering Code Right Hand	Ordering Code Left Hand			
28	16	3/8	16V ER 28 BSPT	16V EL 28 BSPT	1.0	0.6	3.6
19	16	3/8	16V ER 19 BSPT	16V EL 19 BSPT	1.0	0.9	3.6
14	16	3/8	16V ER 14 BSPT	16V EL 14 BSPT	1.0	1.2	3.6
11	16	3/8	16V ER 11 BSPT	16V EL 11 BSPT	1.0	1.5	3.6

Order example: 16V ER 19 BSPT BMA

DIN 477

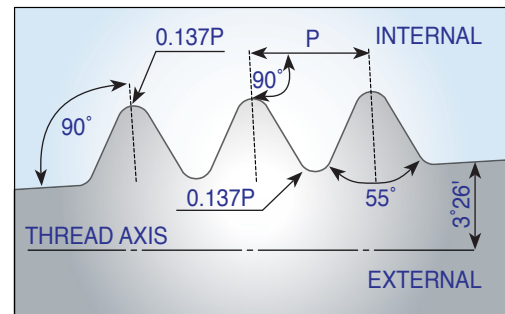

Pitch TPI	L	I.C. in	Taper Ratio	EXTERNAL	INTERNAL	X	Y	Thread Designation
				Ordering Code Right Hand	Ordering Code Right Hand			
14	16	3/8	3/25	16 ER 14 DIN477		1.0	1.2	W19.8x1/14 keg(Ext.)
14	11	1/4	3/25		*11 IR 14 DIN477	0.9	1.0	W19.8x1/14 keg(Int.)
14	16	3/8	3/25	16 ER 14 DIN477	**16 IR 14 DIN477	1.0	1.2	W28.8x1/14 keg
14	16	3/8	3/25	16 ER 14 DIN477	***16 IR 14 DIN477	1.0	1.2	W31.3x1/14 keg

* Holder to use: SIR0010H11/SIR0010K11

** Holder to use: SIR0016P16

*** Holder to use: SIR0020P16

Order example: 16 IR 14 DIN477 BMA

For carbide grade and cutting speed see page A04-2 and 3

Acme

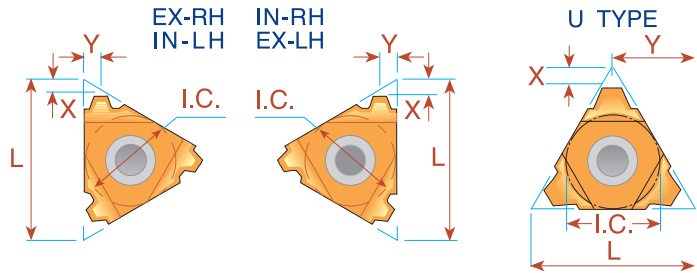
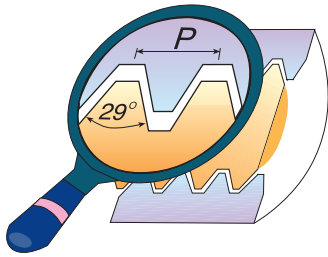

Pitch TPI	L	I.C. in	EXTERNAL		INTERNAL		X	Y
			Ordering Code Right Hand	Ordering Code Left Hand	Ordering Code Right Hand	Ordering Code Left Hand		
16	8	3/16	<i>MINIATURE</i> →		**08 IR 16 ACME	**08 IL 16 ACME	0.6	0.6
14	8U	3/16U	<i>"U" MINIATURE</i> →		*08U IR/L 14 ACME		0.8	4.0
12	8U	3/16U			*08U IR/L 12 ACME		0.8	4.0
10	8U	3/16U			*08U IR/L 10 ACME		0.8	4.0
16	11	1/4	11 ER 16 ACME	11 EL 16 ACME	11 IR 16 ACME	11 IL 16 ACME	0.9	1.0
16	16	3/8	16 ER 16 ACME	16 EL 16 ACME	16 IR 16 ACME	16 IL 16 ACME	0.9	1.0
14	16	3/8	16 ER 14 ACME	16 EL 14 ACME	16 IR 14 ACME	16 IL 14 ACME	1.0	1.2
12	16	3/8	16 ER 12 ACME	16 EL 12 ACME	16 IR 12 ACME	16 IL 12 ACME	1.1	1.2
10	16	3/8	16 ER 10 ACME	16 EL 10 ACME	16 IR 10 ACME	16 IL 10 ACME	1.3	1.3
8	16	3/8	16 ER 8 ACME	16 EL 8 ACME	16 IR 8 ACME	16 IL 8 ACME	1.5	1.5
6	16	3/8	⁽¹⁾ 16 ER 6 ACME	⁽¹⁾ 16 EL 6 ACME	⁽¹⁾ 16 IR 6 ACME	⁽¹⁾ 16 IL 6 ACME	1.7	1.8
6	22	1/2	22 ER 6 ACME	22 EL 6 ACME	22 IR 6 ACME	22 IL 6 ACME	1.8	2.1
5	22	1/2	22 ER 5 ACME	22 EL 5 ACME	22 IR 5 ACME	22 IL 5 ACME	2.0	2.3
4	22	1/2	⁽¹⁾ 22 ER 4 ACME	⁽¹⁾ 22 EL 4 ACME	⁽¹⁾ 22 IR 4 ACME	⁽¹⁾ 22 IL 4 ACME	2.1	2.2
4	22U	1/2U	22U ER/L 4 ACME		22U IR/L 4 ACME		2.3	11.0
4	27	5/8	27 ER 4 ACME	27 EL 4 ACME	27 IR 4 ACME	27 IL 4 ACME	2.3	2.7
3	27U	5/8U	27U ER/L 3 ACME		27U IR/L 3 ACME		2.8	13.7
2	33U	3/4U	33U ER/L 2 ACME		33U IR/L 2 ACME		4.3	16.9

* Available only in BXC and BMA grades

** One cutting edge

Order example: 16 ER 16 ACME MXC

(1) Special holder is required or standard holder can be amended by customer.

Acme Vertical

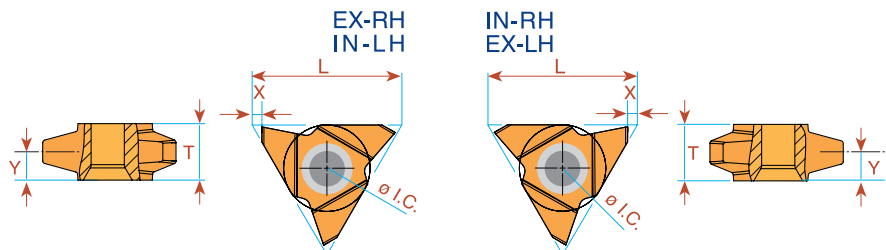

Pitch TPI	L	I.C. in	EXTERNAL		X	Y	T	INTERNAL		X	Y	T
			Ordering Code Right Hand	Ordering Code Left Hand				Ordering Code Right Hand	Ordering Code Left Hand			
* 3.5	27	5/8	27V ER 3.5 ACME	—	1.8	5.0	10.4	27V IR 3.5 ACME	—	1.8	4.0	10.4
* 3	27	5/8	27V ER 3 ACME	—	1.8	5.0	10.4	27V IR 3 ACME	—	1.8	4.6	10.4
** 2	27	5/8	27V ER 2 ACME	27V EL 2 ACME	1.8	5.0	10.4	27V IR 2 ACME	27V IL 2 ACME	1.8	5.0	10.4

* Minimum bore: Ø55 mm ** Minimum bore: Ø76 mm

Order example: 27V ER 2 ACME BMA

For carbide grade and cutting speed see page A04-2 and 3

Stub Acme

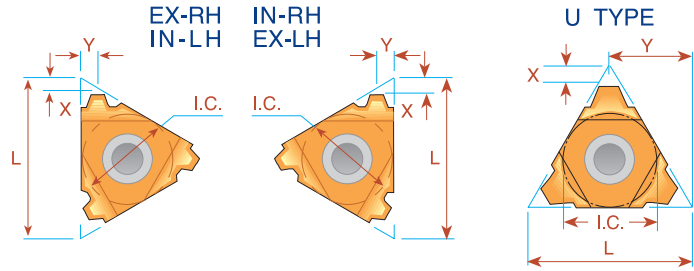
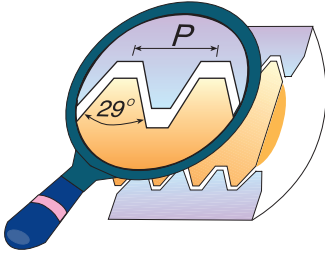

Pitch TPI	L	I.C. in	EXTERNAL		INTERNAL		X	Y
			Right Hand	Left Hand	Right Hand	Left Hand		
16	8	3/16	<i>MINIATURE</i> →		**08 IR 16 STACME	**08 IL 16 STACME	0.6	0.6
14	8U	3/16U	<i>"U" MINIATURE</i> →		*08U IR/L 14 STACME		0.8	4.0
12	8U	3/16U			*08U IR/L 12 STACME		0.9	4.0
10	8U	3/16U			*08U IR/L 10 STACME		1.0	4.0
16	11	1/4	11 ER 16 STACME	11 EL 16 STACME			1.0	1.0
16	16	3/8	16 ER 16 STACME	16 EL 16 STACME	16 IR 16 STACME	16 IL 16 STACME	1.0	1.0
14	16	3/8	16 ER 14 STACME	16 EL 14 STACME	16 IR 14 STACME	16 IL 14 STACME	1.1	1.1
12	16	3/8	16 ER 12 STACME	16 EL 12 STACME	16 IR 12 STACME	16 IL 12 STACME	1.2	1.2
10	16	3/8	16 ER 10 STACME	16 EL 10 STACME	16 IR 10 STACME	16 IL 10 STACME	1.3	1.3
8	16	3/8	16 ER 8 STACME	16 EL 8 STACME	16 IR 8 STACME	16 IL 8 STACME	1.5	1.5
6	16	3/8	16 ER 6 STACME	16 EL 6 STACME	16 IR 6 STACME	16 IL 6 STACME	1.8	1.8
6	22	1/2	22 ER 6 STACME	22 EL 6 STACME	22 IR 6 STACME	22 IL 6 STACME	1.8	1.8
5	22	1/2	22 ER 5 STACME	22 EL 5 STACME	22 IR 5 STACME	22 IL 5 STACME	2.0	2.3
4	22	1/2	22 ER 4 STACME	22 EL 4 STACME	22 IR 4 STACME	22 IL 4 STACME	2.3	2.4
4	22U	1/2U	22U ER/L 4 STACME		22U IR/L 4 STACME		2.5	11.0
3	22U	1/2U	22U ER/L 3 STACME		22U IR/L 3 STACME		3.3	11.0
4	27	5/8	27 ER 4 STACME	27 EL 4 STACME	27 IR 4 STACME	27 IL 4 STACME	2.3	2.4
3	27	5/8	27 ER 3 STACME	27 EL 3 STACME	27 IR 3 STACME	27 IL 3 STACME	2.8	2.9
2	33U	3/4U	33U ER/L 2 STACME		33U IR/L 2 STACME		5.0	16.9

* Available only in BXC and BMA grades

** One cutting edge

Order example: 22 IR 5 STACME MXC

Trapez - DIN 103

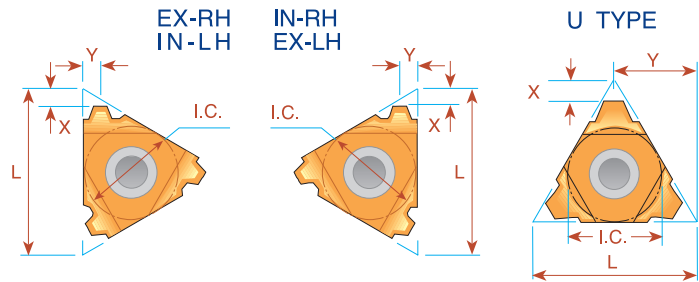
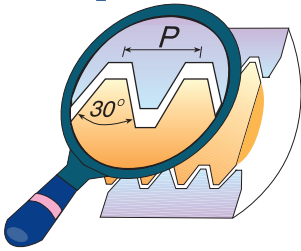

Pitch mm	L	I.C. in	EXTERNAL Ordering Code		INTERNAL Ordering Code		X	Y
			Right Hand	Left Hand	Right Hand	Left Hand		
1.5	8	3/16	MINIATURE		**08 IR 1.5 TR	**08 IL 1.5 TR	0.6	0.6
2.0	8U	3/16U	"U" MINIATURE		*08U IR/L 2 TR		0.9	4.0
1.5	16	3/8	16 ER 1.5 TR	16 EL 1.5 TR	16 IR 2 TR	16 IL 2 TR	1.0	1.1
2.0	16	3/8	16 ER 2 TR	16 EL 2 TR			1.0	1.3
3.0	16	3/8	16 ER 3 TR	16 EL 3 TR	16 IR 3 TR	16 IL 3 TR	1.3	1.5
4.0	16	3/8	(1) 16 ER 4 TR	(1) 16 EL 4 TR	(2) 16 IR 4 TR	(2) 16 IL 4 TR	1.3	1.5
5.0	16U	3/8U			***16U IR/L 5 TR		2.3	8.2
4.0	22	1/2	22 ER 4 TR	22 EL 4 TR	22 IR 4 TR	22 IL 4 TR	1.8	1.9
5.0	22	1/2	22 ER 5 TR	22 EL 5 TR	22 IR 5 TR	22 IL 5 TR	2.0	2.4
6.0	22	1/2	(1) 22 ER 6 TR	(1) 22 EL 6 TR	(1) 22 IR 6 TR	(1) 22 IL 6 TR	2.0	2.4
6.0	22U	1/2U	22U ER/L 6 TR		22U IR/L 6 TR		2.0	11.0
7.0	22U	1/2U	22U ER/L 7 TR		22U IR/L 7 TR		2.3	11.0
(3) 7.0	22U	1/2U			(3) 22U IR/L 7 TR40		2.6	11.0
8.0	22U	1/2U	22U ER/L 8 TR		22U IR/L 8 TR		2.5	11.0
6.0	27	5/8	27 ER 6 TR	27 EL 6 TR	27 IR 6 TR	27 IL 6 TR	2.3	2.7
7.0	27	5/8	27 ER 7 TR	27 EL 7 TR	27 IR 7 TR	27 IL 7 TR	2.2	2.6
8.0	27U	5/8U	27U ER/L 8 TR		27U IR/L 8 TR		2.5	13.7
9.0	27U	5/8U	27U ER/L 9 TR		27U IR/L 9 TR		3.0	13.7
10.0	27U	5/8U	**27U ER/L 10 TR		**27U IR/L 10 TR		3.2	13.7
12.0	33U	3/4U	33U ER/L 12 TR		33U IR/L 12 TR		3.9	16.9

* Available only in BXC and BMA grades

** One cutting edge

*** To be used only with holder SIR/L0014M16UB on page A02-10

Order example: 22 IR 5 TR MXC

(1) Special holder is required or standard holder can be amended by customer.

(2) Special holder is required or standard holder can be amended by customer or to used with holders: SIR/L0012L16B; SIR/L0014L16B

(3) Only for Tr 40 x 7.0. To be used only with holder SIR/L0025S22UB

Trapez - DIN 103 Vertical

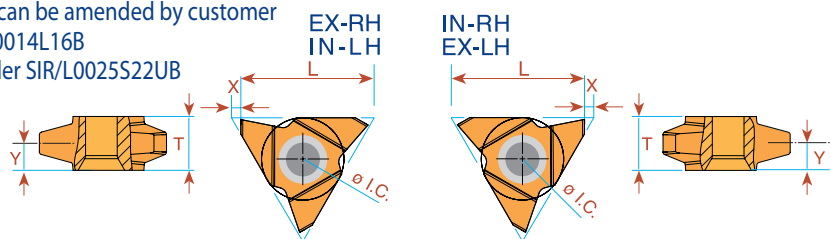

Pitch mm	L	I.C. in	EXTERNAL Ordering Code		INTERNAL Ordering Code		X	Y	T
			Right Hand	Left Hand	Right Hand	Left Hand			
* 9	27	5/8	27V ER 9 TR	27V EL 9 TR	27V IR 9 TR	27V IL 9 TR	1.8	5.2	10.4
* 10	27	5/8	27V ER 10 TR	27V EL 10 TR	27V IR 10 TR	27V IL 10 TR	1.8	5.2	10.4
** 12	27	5/8	27V ER 12 TR	27V EL 12 TR	27V IR 12 TR	27V IL 12 TR	1.8	5.2	10.4

* Minimum bore: Ø65 mm ** Minimum bore: Ø73 mm

Order example: 27V ER 10 TR BMA

For carbide grade and cutting speed see page A04-2 and 3

PG - DIN 40430

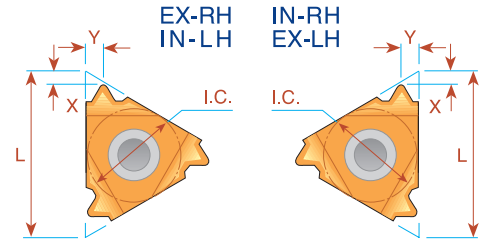
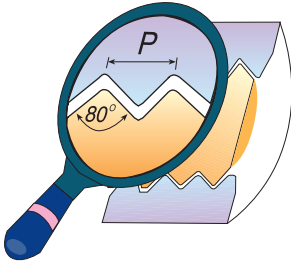

Pitch TPI	L	I.C. in	EXTERNAL		INTERNAL		X	Y
			Right Hand	Standard	Right Hand	Standard		
20	8	3/16	MINIATURE →		*08 IR 20 PG	(PG 7)	0.6	0.7
18	11	1/4			11 IR 18 PG	(PG 9)	0.8	0.9
20	16	3/8	16 ER 20 PG	(PG 7)	16 IR 18 PG	(PG 11, 13.5, 16)	0.7	0.8
18	16	3/8	16 ER 18 PG	(PG 9, 11, 13.5, 16)	16 IR 18 PG	(PG 11, 13.5, 16)	0.8	0.9
16	16	3/8	16 ER 16 PG	(PG 21, 29, 36, 42, 48)	16 IR 16 PG	(PG 21, 29, 36, 42, 48)	0.8	1.0

* Available only in BXC and BMA grades

Order example: 16 ER 16 PG BMA

Sagengewinde - DIN 513

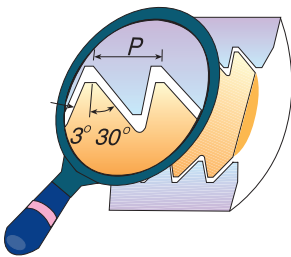

IMPORTANT NOTE:
In CPT standard execution, the flank with the large angle is the leading edge. If otherwise required, please specify in your order.

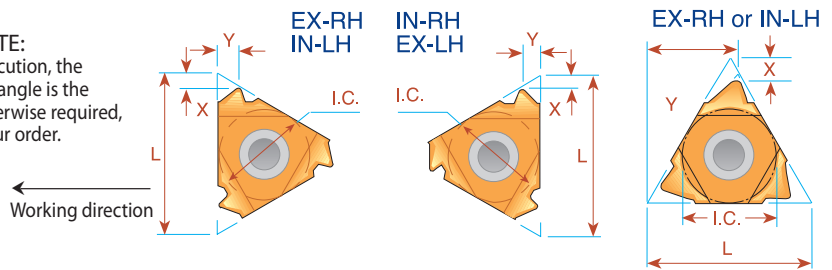

Pitch mm	L	I.C. in	EXTERNAL		X	Y	INTERNAL		X	Y
			Right Hand	Left Hand			Right Hand	Left Hand		
2.0	16	3/8	16 ER 2 SAGE	16 EL 2 SAGE	1.1	1.6	16 IR 2 SAGE	16 IL 2 SAGE	1.2	1.7
**3.0	22	1/2	22 ER 3 SAGE	22 EL 3 SAGE	1.5	2.4	22 IR 3 SAGE	22 IL 3 SAGE	1.9	2.9
**4.0	22	1/2	22 ER 4 SAGE	22 EL 4 SAGE	1.9	3.1	22 IR 4 SAGE	22 IL 4 SAGE	2.3	3.5
*5.0	22U	1/2U	22U ER 5 SAGE	22U EL 5 SAGE	1.2	11.6	22U IR 5 SAGE	22U IL 5 SAGE	1.9	11.7
*6.0	22U	1/2U	22U ER 6 SAGE	22U EL 6 SAGE	1.2	11.7	22U IR 6 SAGE	22U IL 6 SAGE	2.1	11.9

* Requires a special anvil AER 22U-1.5 SAGE 5/6, AEL 22U-1.5 SAGE 5/6, AIR 22U-1.5 SAGE 5/6, AIL 22U-1.5 SAGE 5/6

** Requires a special anvil AER 22-1.5 SAGE 3/4, AEL 22-1.5 SAGE 3/4, AIR 22-1.5 SAGE 3/4, AIL 22-1.5 SAGE 3/4

Order example: 22 IR 4 SAGE BMA

For carbide grade and cutting speed see page A04-2 and 3

Round - DIN 405

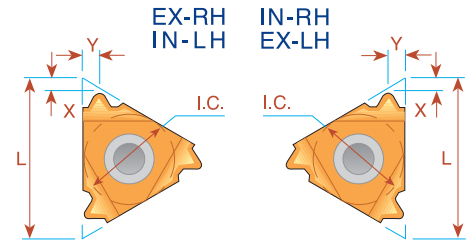
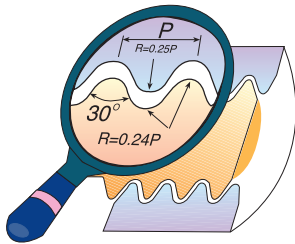

Pitch TPI	L	I.C. in	EXTERNAL		X	Y	INTERNAL		X	Y
			Right Hand	Left Hand			Right Hand	Left Hand		
10	16	3/8	16 ER 10 RD	16 EL 10 RD	1.1	1.2	16 IR 10 RD	16 IL 10 RD	1.1	1.2
8	16	3/8	16 ER 8 RD	16 EL 8 RD	1.4	1.3	16 IR 8 RD	16 IL 8 RD	1.4	1.4
6	16	3/8	16 ER 6 RD	16 EL 6 RD	1.5	1.7	16 IR 6 RD	16 IL 6 RD	1.4	1.5
6	22	1/2	22 ER 6 RD	22 EL 6 RD	1.5	1.7	22 IR 6 RD	22 IL 6 RD	1.5	1.7
4	22	1/2	22 ER 4 RD	22 EL 4 RD	2.2	2.3	22 IR 4 RD	22 IL 4 RD	2.2	2.3
4	27	5/8	27 ER 4 RD	27 EL 4 RD	2.2	2.3	27 IR 4 RD	27 IL 4 RD	2.2	2.3

Order example: 27 IL 4 RD BMA

Round - DIN 20400

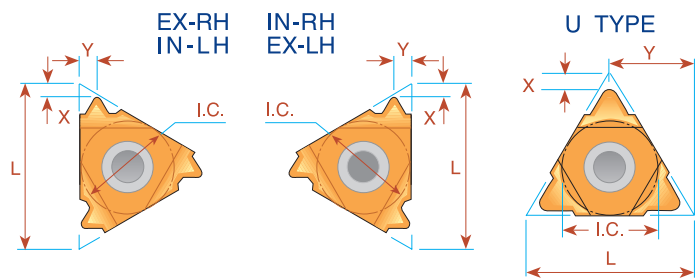
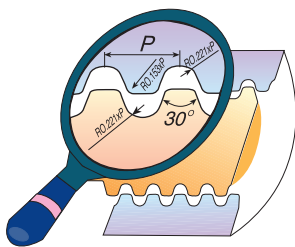

Pitch mm	L	I.C. in	EXTERNAL	INTERNAL	X	Y
			Ordering Code Right Hand	Ordering Code Right Hand		
4.0	22	1/2	22 ER 4.0 RD 20400	22 IR 4.0 RD 20400	1.4	1.4
5.0	22	1/2	22 ER 5.0 RD 20400	22 IR 5.0 RD 20400	1.7	1.8
6.0	22	1/2	22 ER 6.0 RD 20400	22 IR 6.0 RD 20400	1.7	2.0
8.0	27U	5/8U	*27U E/R/L 8.0 RD 20400		3.0	13.7
10.0	27U	5/8U	*27U E/R/L 10.0 RD 20400		3.4	13.7
12.0	33U	3/4U	*33U E/R/L 12.0 RD 20400		4.3	16.9

* Same insert for Internal and External Right Hand Thread

Order example: 22 ER 4.0 RD 20400 MXC

For carbide grade and cutting speed see page A04-2 and 3

UNJ UNJC, UNJF, UNJEF, UNJS

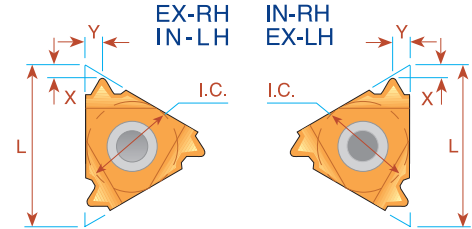
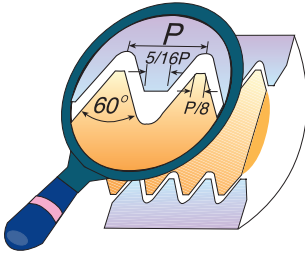

Pitch TPI	L	I.C. in	EXTERNAL		INTERNAL		X	Y
			Right Hand	Left Hand	Right Hand	Left Hand		
28	08	3/16			*08 IR 28 UNJ	*08 IL 28 UNJ	0.6	0.6
24	08	3/16	<i>MINIATURE</i> →		*08 IR 24 UNJ	*08 IL 24 UNJ	0.6	0.6
20	08	3/16			*08 IR 20 UNJ	*08 IL 20 UNJ	0.6	0.7
18	08	3/16			*08 IR 18 UNJ	*08 IL 18 UNJ	0.6	0.7
13	08U	3/16U	<i>"U" MINIATURE</i> →		*08 UIR/L 13 UNJ		0.9	4.0
48	11	1/4	11 ER 48 UNJ	11 EL 48 UNJ	11 IR 48 UNJ	11 IL 48 UNJ	0.6	0.6
44	11	1/4	11 ER 44 UNJ	11 EL 44 UNJ	11 IR 44 UNJ	11 IL 44 UNJ	0.6	0.6
40	11	1/4	11 ER 40 UNJ	11 EL 40 UNJ	11 IR 40 UNJ	11 IL 40 UNJ	0.6	0.6
36	11	1/4	11 ER 36 UNJ	11 EL 36 UNJ	11 IR 36 UNJ	11 IL 36 UNJ	0.6	0.6
32	11	1/4	11 ER 32 UNJ	11 EL 32 UNJ	11 IR 32 UNJ	11 IL 32 UNJ	0.6	0.6
28	11	1/4	11 ER 28 UNJ	11 EL 28 UNJ	11 IR 28 UNJ	11 IL 28 UNJ	0.6	0.6
24	11	1/4	11 ER 24 UNJ	11 EL 24 UNJ	11 IR 24 UNJ	11 IL 24 UNJ	0.7	0.8
20	11	1/4	11 ER 20 UNJ	11 EL 20 UNJ	11 IR 20 UNJ	11 IL 20 UNJ	0.8	0.9
18	11	1/4	11 ER 18 UNJ	11 EL 18 UNJ	11 IR 18 UNJ	11 IL 18 UNJ	0.8	1.0
16	11	1/4	11 ER 16 UNJ	11 EL 16 UNJ	11 IR 16 UNJ	11 IL 16 UNJ	0.8	1.0
14	11	1/4	11 ER 14 UNJ	11 EL 14 UNJ	11 IR 14 UNJ	11 IL 14 UNJ	0.9	1.0
48	16	3/8	16 ER 48 UNJ	16 EL 48 UNJ	16 IR 48 UNJ	16 IL 48 UNJ	0.6	0.6
44	16	3/8	16 ER 44 UNJ	16 EL 44 UNJ	16 IR 44 UNJ	16 IL 44 UNJ	0.6	0.6
40	16	3/8	16 ER 40 UNJ	16 EL 40 UNJ	16 IR 40 UNJ	16 IL 40 UNJ	0.6	0.6
36	16	3/8	16 ER 36 UNJ	16 EL 36 UNJ	16 IR 36 UNJ	16 IL 36 UNJ	0.6	0.6
32	16	3/8	16 ER 32 UNJ	16 EL 32 UNJ	16 IR 32 UNJ	16 IL 32 UNJ	0.6	0.6
28	16	3/8	16 ER 28 UNJ	16 EL 28 UNJ	16 IR 28 UNJ	16 IL 28 UNJ	0.6	0.6
24	16	3/8	16 ER 24 UNJ	16 EL 24 UNJ	16 IR 24 UNJ	16 IL 24 UNJ	0.7	0.8
20	16	3/8	16 ER 20 UNJ	16 EL 20 UNJ	16 IR 20 UNJ	16 IL 20 UNJ	0.8	0.9
18	16	3/8	16 ER 18 UNJ	16 EL 18 UNJ	16 IR 18 UNJ	16 IL 18 UNJ	0.8	1.0
16	16	3/8	16 ER 16 UNJ	16 EL 16 UNJ	16 IR 16 UNJ	16 IL 16 UNJ	0.8	1.0
14	16	3/8	16 ER 14 UNJ	16 EL 14 UNJ	16 IR 14 UNJ	16 IL 14 UNJ	1.0	1.2
13	16	3/8	16 ER 13 UNJ	16 EL 13 UNJ	16 IR 13 UNJ	16 IL 13 UNJ	1.0	1.3
12	16	3/8	16 ER 12 UNJ	16 EL 12 UNJ	16 IR 12 UNJ	16 IL 12 UNJ	1.1	1.4
11	16	3/8	16 ER 11 UNJ	16 EL 11 UNJ	16 IR 11 UNJ	16 IL 11 UNJ	1.1	1.5
10	16	3/8	16 ER 10 UNJ	16 EL 10 UNJ	16 IR 10 UNJ	16 IL 10 UNJ	1.1	1.5
9	16	3/8	16 ER 9 UNJ	16 EL 9 UNJ	16 IR 9 UNJ	16 IL 9 UNJ	1.2	1.6
8	16	3/8	16 ER 8 UNJ	16 EL 8 UNJ	16 IR 8 UNJ	16 IL 8 UNJ	1.2	1.6

* Available only in BXC and BMA grades
Order example: 16 IR 16 UNJ MXC

For carbide grade and cutting speed see page A04-2 and 3

UNJ UNJC, UNJF, UNJEF, UNJS

Type B

Ground profile with sintered chip-breaker

Pitch TPI	L	I.C. in	INTERNAL Ordering Code Right Hand	X	Y
32	11	1/4	11 IR B 32 UNJ	0.6	0.6
28	11	1/4	11 IR B 28 UNJ	0.6	0.6
24	11	1/4	11 IR B 24 UNJ	0.6	0.6
20	11	1/4	11 IR B 20 UNJ	0.8	0.9
18	11	1/4	11 IR B 18 UNJ	0.8	0.9
16	11	1/4	11 IR B 16 UNJ	0.8	0.9
14	11	1/4	11 IR B 14 UNJ	0.8	0.9

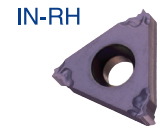

Order example: 11 IR B 20 UNJ BMA

Multitooth

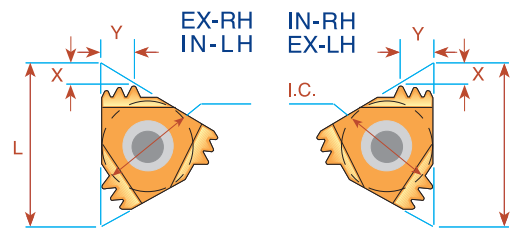
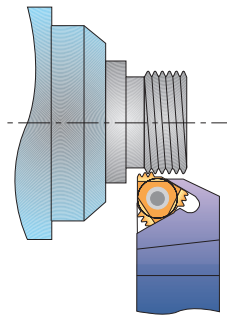

Pitch TPI	L	I.C. in	Number of Teeth	EXTERNAL Ordering Code	Anvil	INTERNAL Ordering Code	Anvil	X	Y
16	16	3/8	2	16 ER 16 UNJ 2M	AE16M	-	-	1.6	2.4
16	22	1/2	3	22 ER 16 UNJ 3M	AE22M	-	-	2.3	3.8

Order example: 22 ER 16 UNJ 3M BMA

MJ - ISO 5855

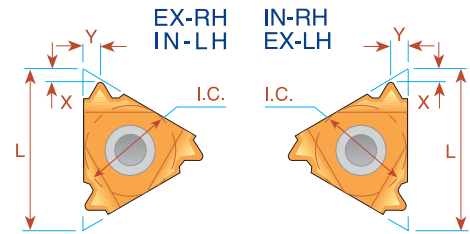
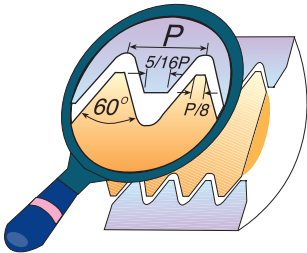

Pitch mm	L	I.C. in	EXTERNAL	INTERNAL	X	Y
			Ordering Code Right Hand	Ordering Code Right Hand		
0.5	11	1/4		11 IR 0.5 MJ	0.5	0.4
0.7	11	1/4		11 IR 0.7 MJ	0.6	0.5
0.75	11	1/4		11 IR 0.75 MJ	0.6	0.5
0.8	11	1/4		11 IR 0.8 MJ	0.6	0.6
1.0	11	1/4	11 ER 1.0 MJ	11 IR 1.0 MJ	0.7	0.8
1.25	11	1/4	11 ER 1.25 MJ	11 IR 1.25 MJ	0.8	0.9
1.5	11	1/4	11 ER 1.5 MJ	11 IR 1.5 MJ	0.8	1.0
2.0	11	1/4		11 IR 2.0 MJ	0.9	1.0
0.5	16	3/8	16 ER 0.5 MJ		0.6	0.6
0.7	16	3/8	16 ER 0.7 MJ		0.6	0.6
0.75	16	3/8	16 ER 0.75 MJ	16 IR 0.75 MJ	0.5	0.5
0.8	16	3/8	16 ER 0.8 MJ	16 IR 0.8 MJ	0.6	0.6
1.0	16	3/8	16 ER 1.0 MJ	16 IR 1.0 MJ	0.7	0.8
1.25	16	3/8	16 ER 1.25 MJ	16 IR 1.25 MJ	0.8	0.9
1.5	16	3/8	16 ER 1.5 MJ	16 IR 1.5 MJ	0.8	1.0
1.75	16	3/8	16 ER 1.75 MJ	16 IR 1.75 MJ	0.9	1.1
2.0	16	3/8	16 ER 2.0 MJ	16 IR 2.0 MJ	1.0	1.3
3.0	16	3/8	16 ER 3.0 MJ	16 IR 3.0 MJ	1.2	1.6

Order example: 16 ER 1.5 MJ BMA

Type B

Ground profile with sintered chip-breaker

Pitch mm	L	I.C. in	INTERNAL	X	Y
			Ordering Code Right Hand		
1.0	11	1/4	11 IR B 1.0 MJ	0.6	0.6
1.5			11 IR B 1.5 MJ	0.8	0.9

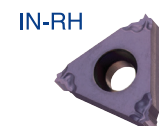

Order example: 11 IR B 1.5 MJ BMA

For carbide grade and cutting speed see page A04-2 and 3

American Buttress

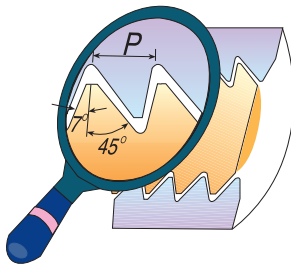

IMPORTANT NOTE:
In CPT standard execution, the flank with the large angle is the leading edge. If otherwise required, please specify in your order.

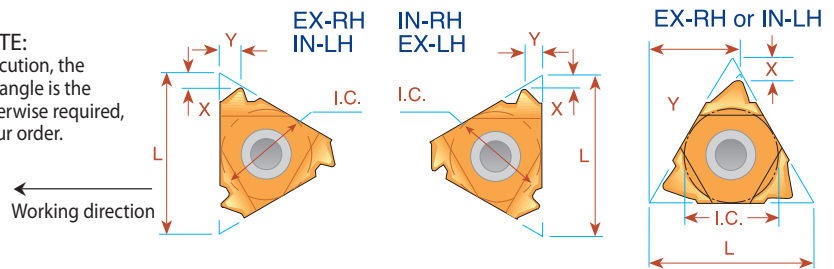

Pitch TPI	L	I.C. in	EXTERNAL		INTERNAL		X	Y
			Right Hand	Left Hand	Right Hand	Left Hand		
20	11	1/4	11 ER 20 ABUT	11 EL 20 ABUT	11 IR 20 ABUT	11 IL 20 ABUT	1.0	1.3
16	11	1/4	11 ER 16 ABUT	11 EL 16 ABUT	11 IR 16 ABUT	11 IL 16 ABUT	1.0	1.5
20	16	3/8	16 ER 20 ABUT	16 EL 20 ABUT	16 IR 20 ABUT	16 IL 20 ABUT	1.0	1.3
16	16	3/8	16 ER 16 ABUT	16 EL 16 ABUT	16 IR 16 ABUT	16 IL 16 ABUT	1.0	1.5
12	16	3/8	16 ER 12 ABUT	16 EL 12 ABUT	16 IR 12 ABUT	16 IL 12 ABUT	1.4	2.0
10	16	3/8	16 ER 10 ABUT	16 EL 10 ABUT	16 IR 10 ABUT	16 IL 10 ABUT	1.5	2.3
8	22	1/2	22 ER 8 ABUT	22 EL 8 ABUT	22 IR 8 ABUT	22 IL 8 ABUT	2.1	3.3
6	22	1/2	22 ER 6 ABUT	22 EL 6 ABUT	22 IR 6 ABUT	22 IL 6 ABUT	2.1	3.4
(1) 4	22U	1/2U	22UER 4 ABUT	22UEL 4 ABUT	22UIR 4 ABUT	22UIL 4 ABUT	2.3	9.5
(3) 5	27	5/8	27 ER 5 ABUT	27 EL 5 ABUT	27 IR 5 ABUT	27 IL 5 ABUT	2.75	4.5
(2) 3	27U	5/8U	27UER 3 ABUT	27UEL 3 ABUT	27UIR 3 ABUT	27UIL 3 ABUT	3.1	11.7

Order example: 16 IL 12 ABUT MXC

Most applications requires anvil change in toolholder see page A04-7

- (1) Requires a special anvil AE 22U-1.5 ABUT4, AI22U-1.5 ABUT4
- (2) Requires a special anvil AE 27U-1.5 ABUT3, AI27U-1.5 ABUT3
- (3) Requires a special anvil AE 27-1.5 ABUT5, AI27-1.5 ABUT5

Multitooth

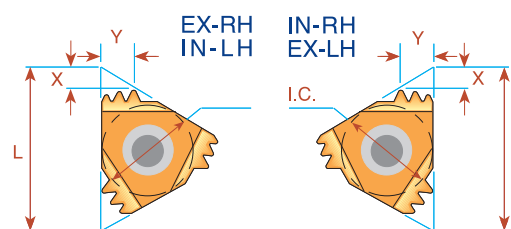
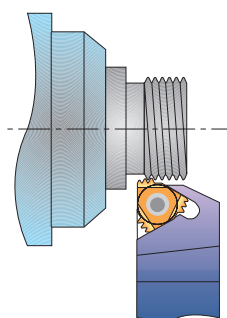

Pitch TPI	L	I.C. in	Number of Teeth	EXTERNAL	Anvil	INTERNAL	Anvil	X	Y
				Ordering Code		Ordering Code			
12	22	1/2	2	22 ER 12 ABUT 2M	AE22M	22 IR 12 ABUT 2M	AI22M	2.5	4.0

Order example: 22 IR 12 ABUT 2M BMA

For carbide grade and cutting speed see page A04-2 and 3

Threading Tools for the Oil & Gas Industries

API Round

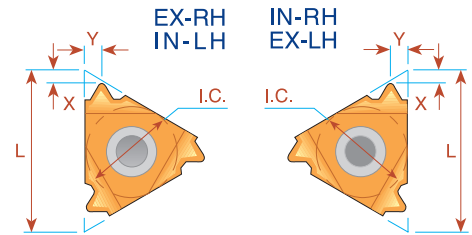
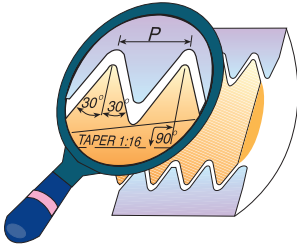

Pitch TPI	L	I.C. in	Taper IPF	EXTERNAL Ordering Code Right Hand	INTERNAL Ordering Code Right Hand	X	Y
10	16	3/8	0.75	16 ER 10 API RD	16 IR 10 API RD	1.5	1.4
8	16	3/8	0.75	16 ER 8 API RD	16 IR 8 API RD	1.3	1.6

Order example: 16 ER 10 API RD BMA

Multitooth

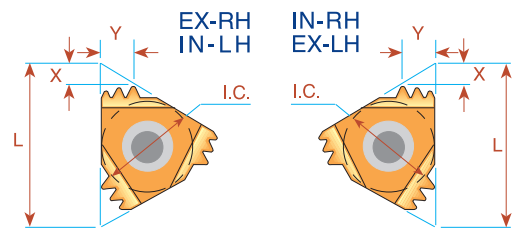
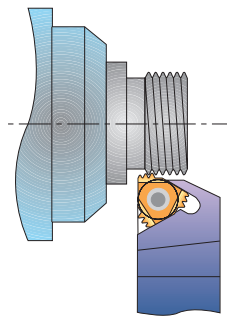

Pitch TPI	L	I.C. in	Number of Teeth	EXTERNAL Ordering Code	Anvil	INTERNAL Ordering Code	Anvil	X	Y
10	22	1/2	2	22 ER 10 API RD 2M	AE22M	22 IR 10 API RD 2M	AI22M	2.4	3.7
10	27	5/8	3	27 ER 10 API RD 3M	AE27M	27 IR 10 API RD 3M	AI27M	3.8	6.2
8	27	5/8	2	27 ER 8 API RD 2M	AE27M	27 IR 8 API RD 2M	AI27M	3.0	4.5

Order example: 27 IR 10 API RD 3M MXC

For recommended number of passes see page A04-4

For carbide grade and cutting speed see page A04-2 and 3

OIL Threads

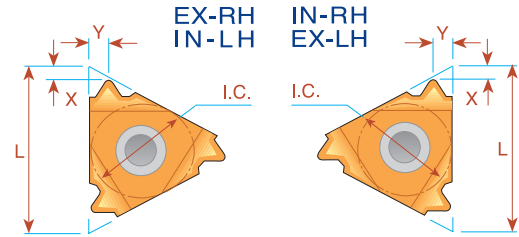
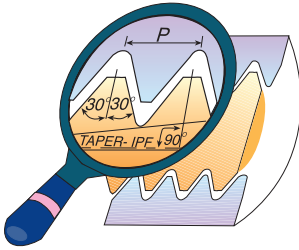

V-0.040

Pitch TPI	L	I.C. in	Taper IPF	EXTERNAL Ordering Code Right Hand	INTERNAL Ordering Code Right Hand	X	Y	Connection No. or Size
5	22	1/2	3	22 ER 5 API 403	22 IR 5 API 403	1.8	2.5	23/8-4 1/2 REG

(1) V-0.038R

Pitch TPI	L	I.C. in	Taper IPF	EXTERNAL Ordering Code Right Hand	INTERNAL Ordering Code Right Hand	X	Y	Connection No. or Size
4	27	5/8	2	27 ER 4 API 382	27 IR 4 API 382	2.1	2.8	NC23-NC50
4	27	5/8	3	27 ER 4 API 383	27 IR 4 API 383	2.1	2.8	NC56-NC77
4	22	1/2	2	22 ER 4 API 382	22 IR 4 API 382	2.0	2.5	NC23-NC50
4	22	1/2	3	22 ER 4 API 383	22 IR 4 API 383	2.0	2.6	NC56-NC77

Order example: 27 ER 4 API 383 MXC

(1) V-0.050

Pitch TPI	L	I.C. in	Taper IPF	EXTERNAL Ordering Code Right Hand	INTERNAL Ordering Code Right Hand	X	Y	Connection No. or Size
4	27	5/8	2	27 ER 4 API 502	27 IR 4 API 502	2.0	3.0	65/8 REG
4	27	5/8	3	27 ER 4 API 503	27 IR 4 API 503	2.0	3.0	5 1/2, 75/8, 85/8 REG
4	22	1/2	2	22 ER 4 API 502	22 IR 4 API 502	1.9	2.7	65/8 REG
4	22	1/2	3	22 ER 4 API 503	22 IR 4 API 503	1.9	2.8	5 1/2, 75/8, 85/8 REG

Order example: 22 ER 4 API 502 BMA

V-0.055

Macaroni Tubing (MT)

American Macaroni Tubing (AMT)

American Mining Macaroni Tubing (AMMT)

Pitch TPI	L	I.C. in	Taper IPF	EXTERNAL Ordering Code Right Hand	INTERNAL Ordering Code Right Hand	X	Y	Connection No. or Size
6	22	1/2	1.5	22 ER 6 API 551.5	-	2.0	1.7	NC10,NC12,NC13,NC16
6	16	3/8	1.5	-	16 IR 6 API 551.5	2.0	1.7	NC10,NC12,NC13 *
6	22	1/2	1.5	-	22 IR 6 API 551.5	2.0	1.7	NC16 **

* For NC10,NC12 use holder SIR0016P16CB
For NC13 use holders SIR0020P16/SIR0020P16B/SIR0020S16CB

** For NC16 use holder SIR0025R22

(1) For V-0.038R, V-0.050 we recommend to use size 27 for more stability.

For carbide grade and cutting speed see page A04-2 and 3

OIL Threads Extreme - Line Casing

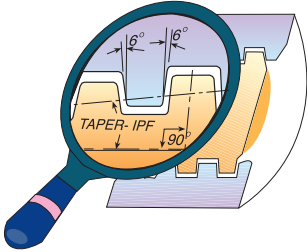

Pitch TPI	L	I.C. in	Taper IPF	EXTERNAL	INTERNAL	X	Y	Connection No. or Size
				Ordering Code Right Hand	Ordering Code Right Hand			
6	22	1/2	1.50	22 ER 6 EL 1.5	22 IR 6 EL 1.5	1.9	1.9	5 - 7 ⁵ / ₈
5	22	1/2	1.25	22 ER 5 EL 1.25	22 IR 5 EL 1.25	2.4	2.3	8 ⁵ / ₈ -10 ³ / ₄

Buttress Casing

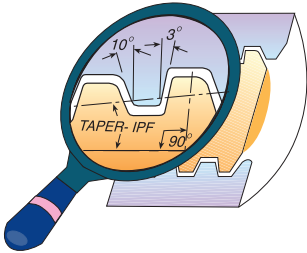

Pitch TPI	L	I.C. in	Taper IPF	EXTERNAL	INTERNAL	X	Y	Connection No. or Size
				Ordering Code Right Hand	Ordering Code Right Hand			
5	22	1/2	0.75	22 ER 5 BUT 0.75	22 IR 5 BUT 0.75	2.2	2.4	4 ¹ / ₂ -13 ³ / ₈
5	22	1/2	1.00	22 ER 5 BUT 1.0	22 IR 5 BUT 1.0	2.3	2.4	16 -20

Order example: 22 ER 5 BUT 0.75 MXC

VAM

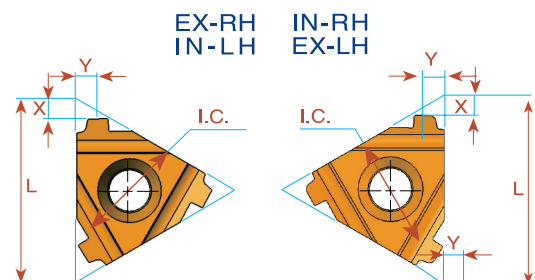
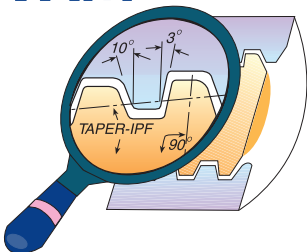

Pitch TPI	L	I.C. in	Taper IPF	EXTERNAL	X	Y	INTERNAL	X	Y	Connection No. or Size
				Ordering Code Right Hand			Ordering Code Right Hand			
8	16	3/8	0.75	16 ER 8 VAM	1.7	1.8	16 IR 8 VAM	1.7	1.8	2 ³ / ₈ - 2 ⁷ / ₈
6	22	1/2	0.75	22 ER 6 VAM	2.4	2.4	22 IR 6 VAM	2.5	2.5	3 ¹ / ₂ - 4 ¹ / ₂
5	22	1/2	0.75	22 ER 5 VAM	2.4	2.7	22 IR 5 VAM	2.4	2.5	5 - 13 ³ / ₈

Order example: 16 ER 8 VAM BMA

For carbide grade and cutting speed see page A04-2 and 3

HUGHES

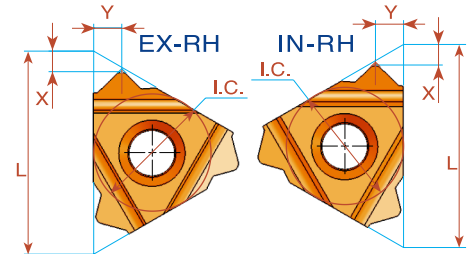
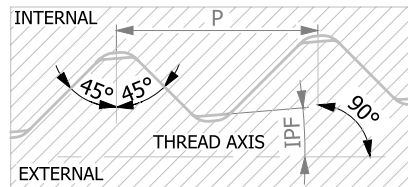

Pitch TPI	L mm	I.C.	Taper IPF	EXTERNAL	INTERNAL	X	Y	Connection No. or Size
				Ordering Code Right Hand	Ordering Code Right Hand			
3.5	27	5/8	2	27 ER 3.5 H-902	27 IR 3.5 H-902	2.8	3.8	31/2 - 65/8
3.5	27	5/8	3	27 ER 3.5 H-903	27 IR 3.5 H-903	2.8	3.8	7 - 85/8
3	27	5/8	1.25	27 ER 3 SLH-90	27 IR 3 SLH-90	3.3	4.6	23/8 - 31/2

Order example: 27 ER 3.5 H-903 BMA

PAC

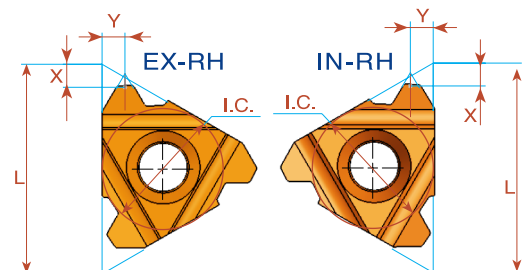
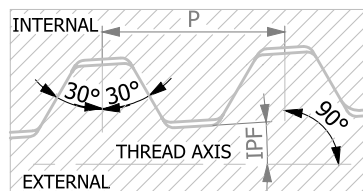

Pitch TPI	L mm	I.C.	Taper IPF	EXTERNAL	INTERNAL	X	Y	Connection No. or Size
				Ordering Code Right Hand	Ordering Code Right Hand			
4	22	1/2	1.5	22 ER 4 PAC	22 IR 4 PAC	2.3	2.3	21/2 - 27/8
4	27	5/8	1.5	27 ER 4 PAC	27 IR 4 PAC	2.3	2.3	21/2 - 27/8

Order example: 22 ER 4 PAC MXC

NPS

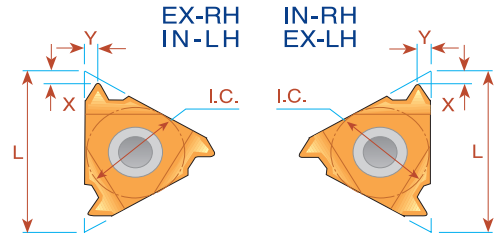
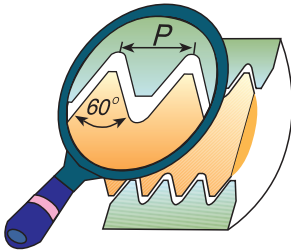

Pitch TPI	L mm	I.C.	EXTERNAL		INTERNAL		X	Y
			Right Hand	Left Hand	Right Hand	Left Hand		
18	16	3/8	16 ER 18 NPS	16 EL 18 NPS	16 IR 18 NPS	16 IL 18 NPS	0.8	1
14	16	3/8	16 ER 14 NPS	16 EL 14 NPS	16 IR 14 NPS	16 IL 14 NPS	1	1.3
11.5	16	3/8	16 ER 11.5 NPS	16 EL 11.5 NPS	16 IR 11.5 NPS	16 IL 11.5 NPS	1	1.5
8	16	3/8	16 ER 8 NPS	16 EL 8 NPS	16 IR 8 NPS	16 IL 8 NPS	1.3	1.8

Order example: 16 ER 18 NPS BMA

NPSM

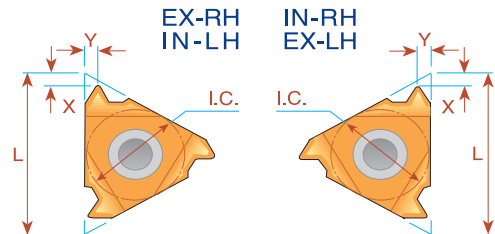
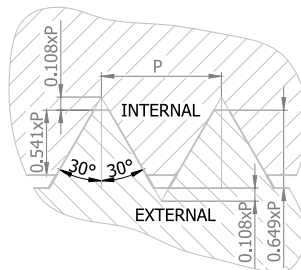

Pitch TPI	L mm	I.C.	EXTERNAL	X	Y	INTERNAL	X	Y
			Ordering Code Right Hand			Ordering Code Right Hand		
18	8	3/16				08 IR 18 NPSM	0.7	0.7
18	11	1/4				11 IR 18 NPSM	0.8	1.0
18	16	3/8	16 ER 18 NPSM	0.8	1.0			
14	16	3/8	16 ER 14 NPSM	1.0	1.2			
11.5	16	3/8	16 ER 11.5 NPSM	1.2	1.5			
8	16	3/8	16 ER 8 NPSM	1.3	1.6	16 IR 8 NPSM	1.2	1.5

Order example: 16 IR 14 NPSM MXC

For carbide grade and cutting speed see page A04-2 and 3

Vertical API

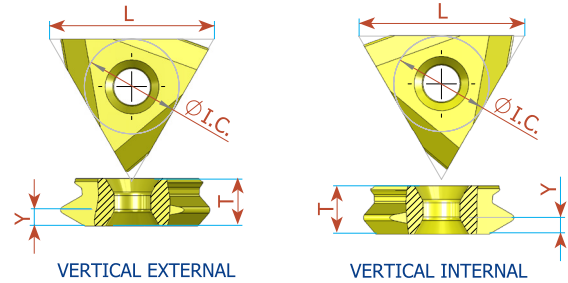
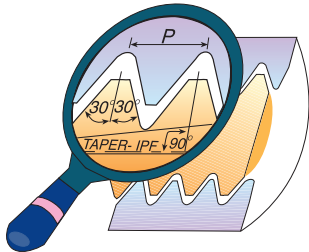

Thread Form	Pitch TPI	L	I.C. in	Taper IPF	EXTERNAL Ordering Code	Y	T	Connection No. or Size
V-0.040	5	27	5/8	3	TNMB 54 ER 5 API 403	2.5	6.4	23/8-41/2 REG
V-0.038R	4	27	5/8	2	TNMC 55 ER 4 API 382	2.8	7.94	NC23-NC50
V-0.038R	4	27	5/8	3	TNMC 55 ER 4 API 383	2.8	7.94	NC56-NC77
V-0.050	4	27	5/8	2	TNMC 55 ER 4 API 502	3.0	7.94	65/8 REG
V-0.050	4	27	5/8	3	TNMC 55 ER 4 API 503	3.0	7.94	51/2, 75/8, 85/8 REG

Vertical inserts to be used with compatible holders on the market

Order example: TNMC 55 ER 4 API 503 BMA

Thread Form	Pitch TPI	L	I.C. in	Taper IPF	INTERNAL Ordering Code	Y	T	Connection No. or Size
V-0.040	5	27	5/8	3	TNMB 54 IR 5 API 403	2.5	6.4	23/8-41/2 REG
V-0.038R	4	27	5/8	2	TNMC 55 IR 4 API 382	2.8	7.94	NC23-NC50
V-0.038R	4	27	5/8	3	TNMC 55 IR 4 API 383	2.8	7.94	NC56-NC77
V-0.050	4	27	5/8	2	TNMC 55 IR 4 API 502	3.0	7.94	65/8 REG
V-0.050	4	27	5/8	3	TNMC 55 IR 4 API 503	3.0	7.94	51/2, 75/8, 85/8 REG

Vertical inserts to be used with compatible holders on the market

Order example: TNMC 55 IR 4 API 502 BMA

Vertical

API Buttress Casing

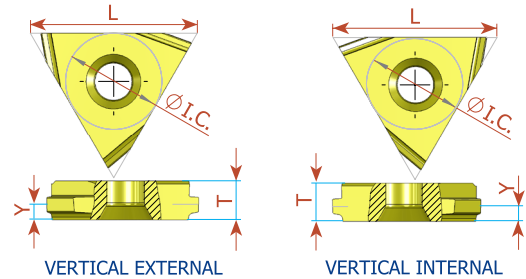
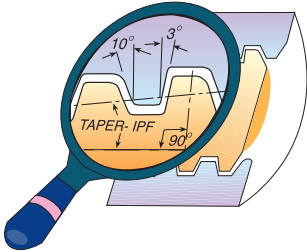

Pitch TPI	L	I.C. in	Taper IPF	EXTERNAL Ordering Code	Y	T	Connection No. or Size
5	27	5/8	0.75	TNMB 54 ER 5 BUT 0.75	2.4	6.4	4 1/2 -13 3/8
5	27	5/8	1.00	TNMB 54 ER 5 BUT 1.0	2.4	6.4	16 -20

Order example: TNMB 54 ER 5 BUT 1.0 BMA

Pitch TPI	L	I.C. in	Taper IPF	INTERNAL Ordering Code	Y	T	Connection No. or Size
5	27	5/8	0.75	TNMB 54 IR 5 BUT 0.75	2.4	6.4	4 1/2 -13 3/8
5	27	5/8	1.00	TNMB 54 IR 5 BUT 1.0	2.4	6.4	16 -20

Vertical inserts to be used with compatible holders on the market

Order example: TNMB 54 IR 5 BUT 0.75 BMA

Vertical API Round

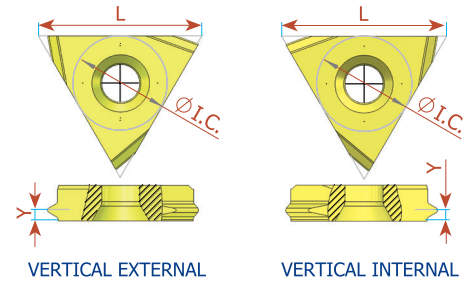
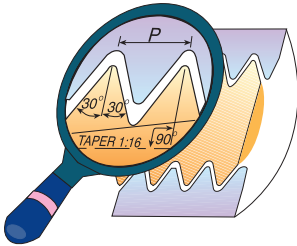

Pitch TPI	L	I.C. in	Taper IPF	EXTERNAL Ordering Code	Y	T
10	22	1/2	0.75	TNMB 43 ER 10 API RD	1.45	4.76
8	22	1/2	0.75	TNMB 43 ER 8 API RD	1.65	4.76

Order example: TNMB 43 ER 10 API RD BMA

Pitch TPI	L	I.C. in	Taper IPF	INTERNAL Ordering Code	Y	T
10	22	1/2	0.75	TNMB 43 IR 10 API RD	1.45	4.76
8	22	1/2	0.75	TNMB 43 IR 8 API RD	1.65	4.76

Vertical inserts to be used with compatible holders on the market

Order example: TNMB 43 IR 8 API RD BMA

Chasers

API Round

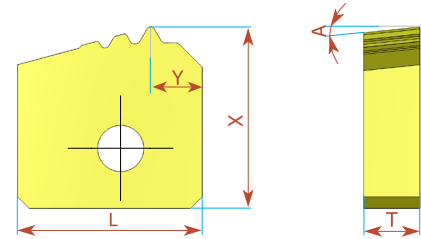

Pitch TPI	L	Taper IPF	EXTERNAL Ordering Code	X	Y	T	A	No. of Teeth
10	15.75	0.75	15.75 ER 10 API RD 3T	15.435	4.4	4.76	6°	3
8	15.75	0.75	15.75 ER 8 API RD 3T	15.84	4.4	4.76	6°	3

Order example: 15.75 ER 10 API RD 3T BMA

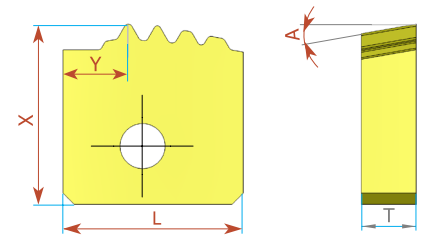

Pitch TPI	L	Taper IPF	INTERNAL Ordering Code	X	Y	T	A	No. of Teeth
10	15.75	0.75	15.75 IR 10 API RD 4T	15.75	5.7	4.76	10°	4
8	15.875	0.75	15.875 IR 8 API RD 4T	15.75	4.2	4.76	10°	4

Chasers to be used with compatible holders on the market

Order example: 15.75 IR 10 API RD 4T BMA

Chasers

API Buttress Casing

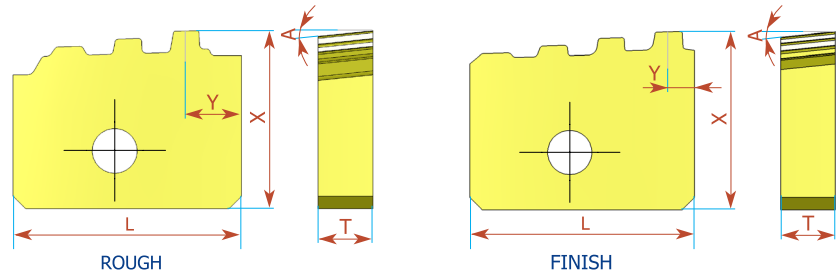

Pitch TPI	L	Taper IPF	EXTERNAL Ordering Code	X	Y	T	A	No. of Teeth
5	20	0.75	20 ER 5 BUT 0.75R	15.692	4.84	4.76	6°	3
5	20	0.75	20 ER 5 BUT 0.75F	15.875	2.3	4.76	6°	4

Order example: 20 ER 5 BUT 0.75F BMA

Chasers

OTTM Buttress Casing

Pitch TPI	L	Taper IPF	EXTERNAL Ordering Code	X	Y	T	A	No. of Teeth
5	20	0.75	20 ER 5 OTTM 0.75R	15.692	4.79	4.76	6°	3
5	20	0.75	20 ER 5 OTTM 0.75F	15.909	2.25	4.76	6°	4

Chasers to be used with compatible holders on the market

Order example: 20 ER 5 OTTM 0.75F BMA

Chasers

API Buttress Casing

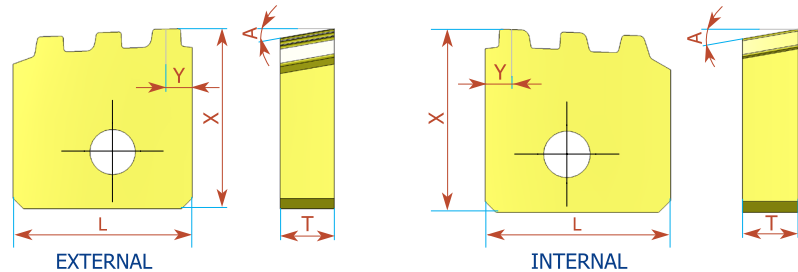

Pitch TPI	L	Taper IPF	EXTERNAL Ordering Code	X	Y	T	A	No. of Teeth
5	15.75	0.75	15.75 ER 5 BUT 0.75 3T	15.875	2.3	4.76	10°	3

Pitch TPI	L	Taper IPF	INTERNAL Ordering Code	X	Y	T	A	No. of Teeth
5	15.875	0.75	15.875 IR 5 BUT 0.75 3T	15.75	2.5	4.76	10°	3

Order example: 15.75 ER 5 BUT 0.75 3T BMA

Chasers

OTTM Buttress Casing

Pitch TPI	L	Taper IPF	EXTERNAL Ordering Code	X	Y	T	A	No. of Teeth
5	15.75	0.75	15.75 ER 5 OTTM 0.75 3T	15.75	3.0	4.76	6°	3

Pitch TPI	L	Taper IPF	INTERNAL Ordering Code	X	Y	T	A	No. of Teeth
5	15.875	0.75	15.875 IR 5 OTTM 0.75 3T	15.875	2.5	4.76	10°	3

Chasers to be used with compatible holders on the market

Order example: 15.75 ER 5 OTTM 0.75 3T BMA

Chasers

API Buttress Casing

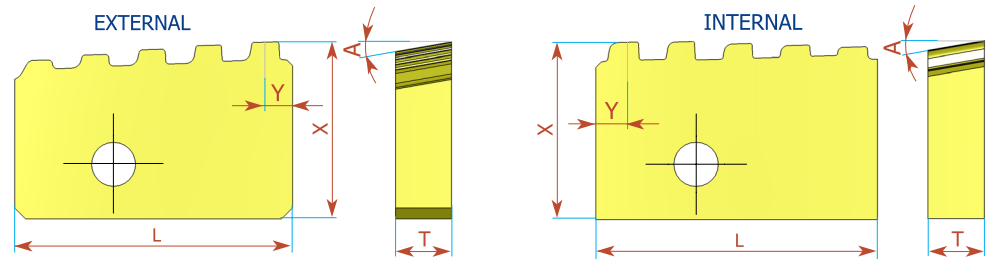

Pitch TPI	L	Taper IPF	EXTERNAL Ordering Code	X	Y	T	A	No. of Teeth
5	25	0.75	25 ER 5 BUT 0.75 5T	15.871	2.5	5	10°	5

Pitch TPI	L	Taper IPF	INTERNAL Ordering Code	X	Y	T	A	No. of Teeth
5	25	0.75	25 IR 5 BUT 0.75 5T	15.875	2.5	5	10°	5

Order example: 25 IR 5 BUT 0.75 5T BMA

Chasers

OTTM Buttress Casing

Pitch TPI	L	Taper IPF	INTERNAL Ordering Code	X	Y	T	A	No. of Teeth
5	25	0.75	25 IR 5 OTTM 0.75 5T	15.75	2.5	5	10°	5

Chasers to be used with compatible holders on the market

Order example: 25 IR 5 OTTM 0.75 5T BMA

Chasers

API Buttress Casing

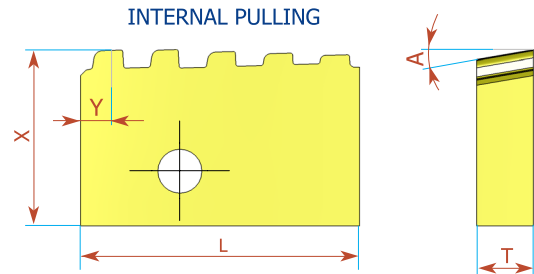

Pitch TPI	L	Taper IPF	INTERNAL Ordering Code	X	Y	T	A	No. of Teeth
5	25	0.75	25 IRP 5 BUT 0.75 5T	15.75	2.5	5	10°	5

Order example: 25 IRP 5 BUT 0.75 5T BMA

Chasers

OTTM Buttress Casing

Pitch TPI	L	Taper IPF	INTERNAL Ordering Code	X	Y	T	A	No. of Teeth
5	25	0.75	25 IRP 5 OTTM 0.75 5T	15.75	2.5	5	10°	5

Chasers to be used with compatible holders on the market

Order example: 25 IRP 5 OTTM 0.75 5T BMA

Large Profile Inserts and Toolholders

- Wide range of pitches
- Rigid clamping
- Tailor made profiles according to customer's request are possible



External

Internal

Large Profile Inserts

Trapez - DIN 103

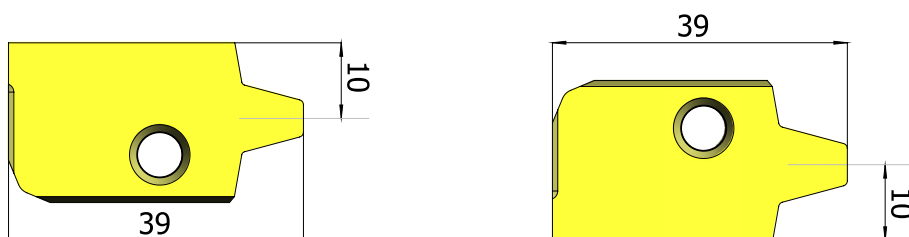

Pitch mm	Ordering Code EX RH	Holder Code	Ordering Code EX LH	Holder Code	Ordering Code IN RH	Holder Code	Ordering Code IN LH	Holder Code
14	40 ER 14 TR	H1	40 EL 14 TR	H2	40 IR 14 TR	H7, 6	40 IL 14 TR	H8, 5
16	40 ER 16 TR		40 EL 16 TR		40 IR 16 TR		40 IL 16 TR	
18	40 ER 18 TR		40 EL 18 TR		40 IR 18 TR		40 IL 18 TR	
20	40 ER 20 TR	H3	40 EL 20 TR	H4	40 IR 20 TR	H9	40 IL 20 TR	H10
22	40 ER 22 TR		40 EL 22 TR		40 IR 22 TR		40 IL 22 TR	
24	40 ER 24 TR		40 EL 24 TR		40 IR 24 TR		40 IL 24 TR	

Carbide grade: BMA or MXC

Order example: 40 ER 18 TR BMA

External Holders

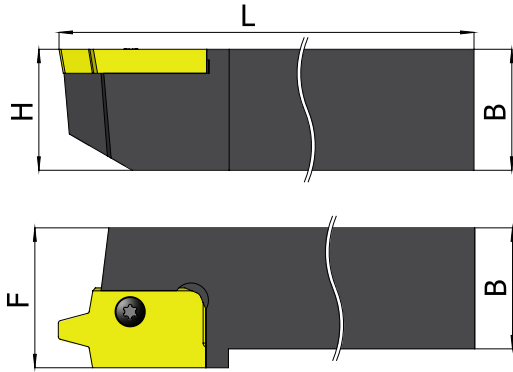

Pitch Range (mm) 14, 16, 18 Ordering Code		B=H	L	F	Insert Screw	Torx Screw	Holder No.
EX-RH	SER 3232 P40	32	170	32	S40	K40	H1
EX-LH	SEL 3232 P40	32	170	32	S40	K40	H2

Pitch Range (mm) 20, 22, 24 Ordering Code		B=H	L	F	Insert Screw	Side Screw	Torx Screw	Holder No.
EX-RH	SER 3232 P40T	32	170	32	S40	A27	K40	H3
EX-LH	SEL 3232 P40T	32	170	32	S40	A27	K40	H4

Pitch Range (mm) 14, 16, 18 Ordering Code		B=H	L	F	Insert Screw	Torx Screw	Holder No.
EX-RH	SER 2525 M40	25	150	32	S40	K40	*H5
EX-LH	SEL 2525 M40	25	150	32	S40	K40	*H6

* H5 and H6 toolholders to be used with toolbar provided by the customer

Internal Holders

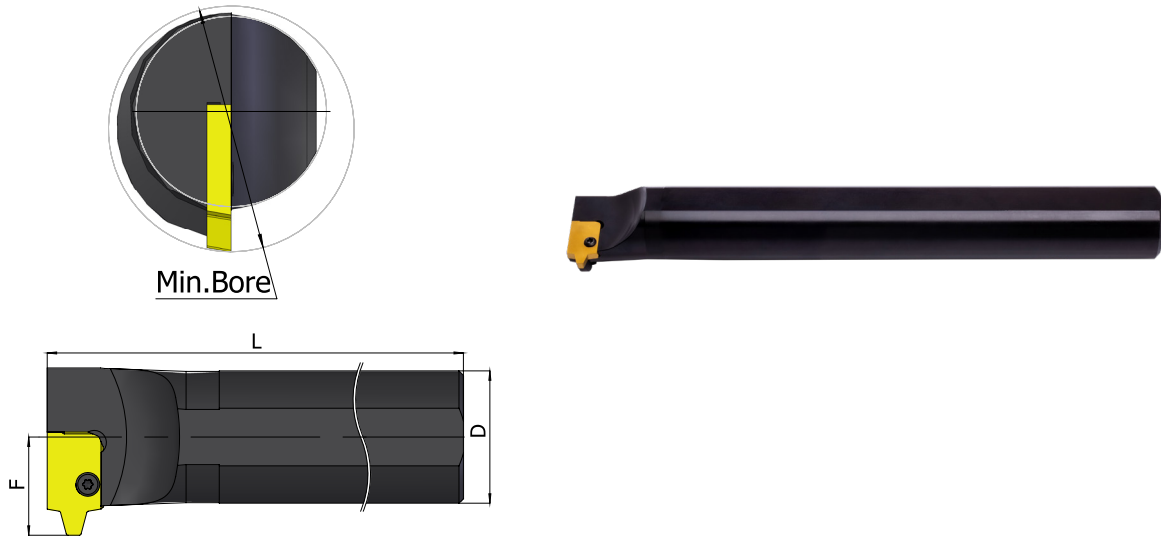

Pitch Range (mm) 14, 16, 18 Ordering Code		D	Min Bore Diam.	L	F	Insert Screw	Torx Screw	Holder No.
IN-RH	SIR 0050 V40	50	70	400	37	S40	K40	H7
IN-LH	SIL 0050 V40	50	70	400	37	S40	K40	H8

Pitch Range (mm) 20, 22, 24 Ordering Code		D	Min Bore Diam.	L	F	Insert Screw	Side Screw	Torx Screw	Holder No.
IN-RH	SIR 0050 V40T	50	70	400	37	S40	A27	K40	H9
IN-LH	SIL 0050 V40T	50	70	400	37	S40	A27	K40	H10

Large Profile Sagengewinde Inserts

DIN 513

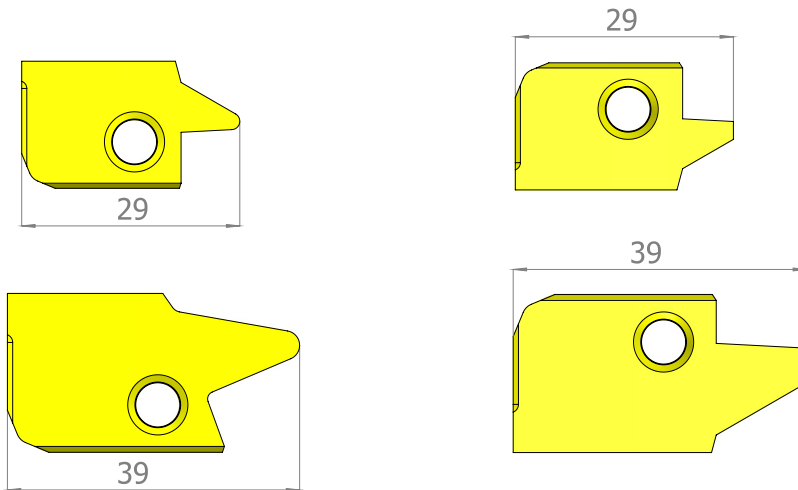

Pitch mm	Ordering Code EX RH	Holder Code	Ordering Code IN RH	Holder Code
9	30 ER 9 SAGE	S1, 2	30 IR 9 SAGE	S7
10	40 ER 10 SAGE	S3, 4	40 IR 10 SAGE	S8
12	40 ER 12 SAGE	S3, 4	40 IR 12 SAGE	S9
14	40 ER 14 SAGE	S5	40 IR 14 SAGE	S10
16	40 ER 16 SAGE	S6	40 IR 16 SAGE	S11

Carbide grade: BMA or MXC

Order example: 40 ER 10 SAGE MXC

Additional profiles upon request

Round (DIN 20400)

Acme, Stub Acme

American Buttress

External Holders

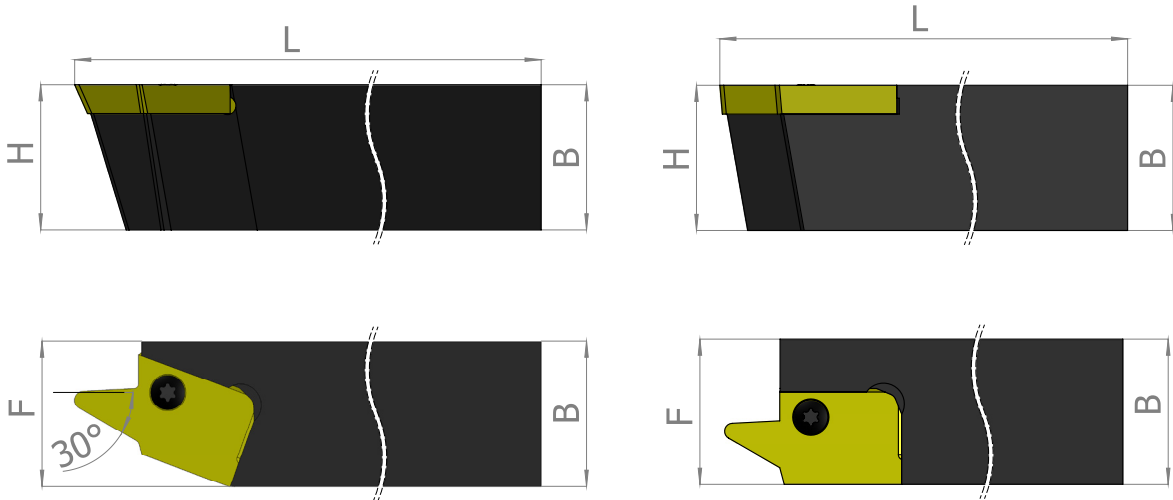

Version A

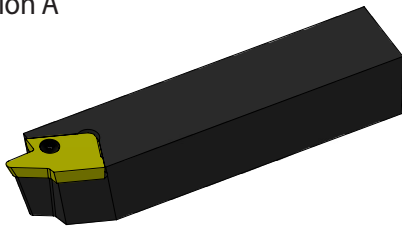

Version B

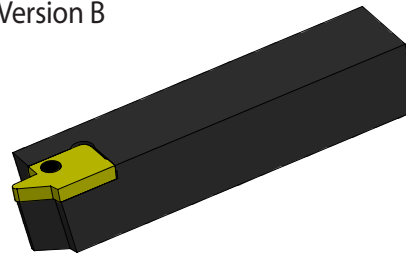

The flank with the large angle is the leading edge

Ordering Code		B=H	L	F	Insert Screw	Torx Screw	Version	Holder No.
EX-RH	SER 2525 M30	25	150	25	S30	K30	B	S1
	SER 3232 P30	32	170	32	S30	K30	B	S2
	SER 2525 M40T	25	150	32	S40	K40	B	S3
	SER 3232 P40S	32	170	32	S40	K40	B	S4
	SER 3232 P40W	32	170	32	S40	K40	B	S5
	SER 3232 P40Q	32	170	32	S40	K40	A	S6

Internal Holders

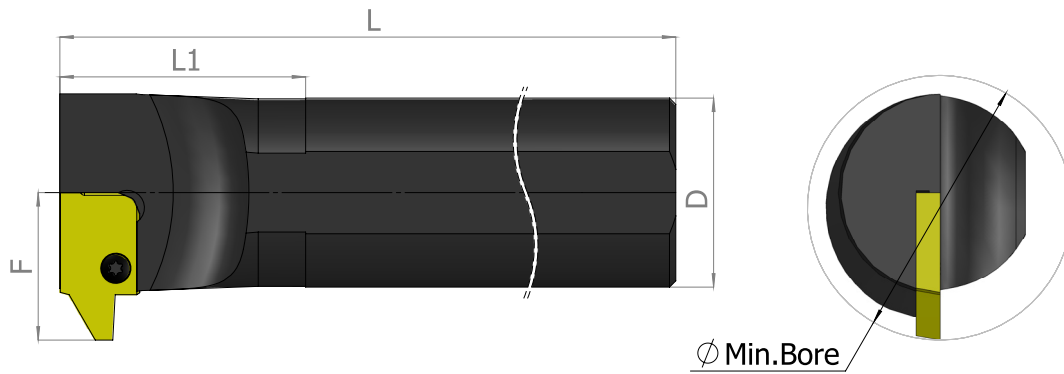

Ordering Code	D	Min Bore Diam.	L	L1	F	Insert Screw	Torx Screw	Holder No.
SIR 0032 S30	32	40.0	250	120	24.0	S30	K30	S7
SIR 0040 T40	40	49.0	300	140	28.0	S40	K40	S8
IN-RH SIR 0050 U40	50	65.0	350	-	35.0	S40	K40	S9
SIR 0060 V40	60	80.0	400	-	41.0	S40	K40	S10
SIR 0060 V40T	60	80.0	400	-	43.0	S40	K40	S11

Thread Turning Toolholders and Kits

A02



Contents:	Page:	Contents:	Page:
Product Identification	2	Star Toolholders Ø22	12
External Toolholders	3	Modular Line	13
Off-Set Toolholders	4	Applications	14
External Toolholders with Top Clamp	5	Product Identification	15
Vertical Toolholders	5	ML Turning Adaptors	16
Slim Throat Toolholders	5	Boring Bars	16
Drophead Toolholders	6	Quick Change	17
Gang Toolholders	6	External Toolholders	17
X-tream Jet:		Internal Toolholders	18
External Toolholder with Internal Coolant	7	Thread Helix Angle	19
Internal Toolholders	8	Standard and Slanted Anvils	19
Internal Toolholders with Coolant Bore	9	Anvil Kits	20
Internal Toolholders with Top Clamp	9	Standard Kits	21
Toolholders with 3.5° Helix Angle	9	Miniature & Ultra-Miniature Kits	21
Special Thread Turning Applications	10	Inserts' Kits	22
Carbide Shank Threading Bars	11	Threading & Boring Combination Kit	23
Vertical Toolholders	11		

Product Identification

Threading Toolholders Ordering Codes

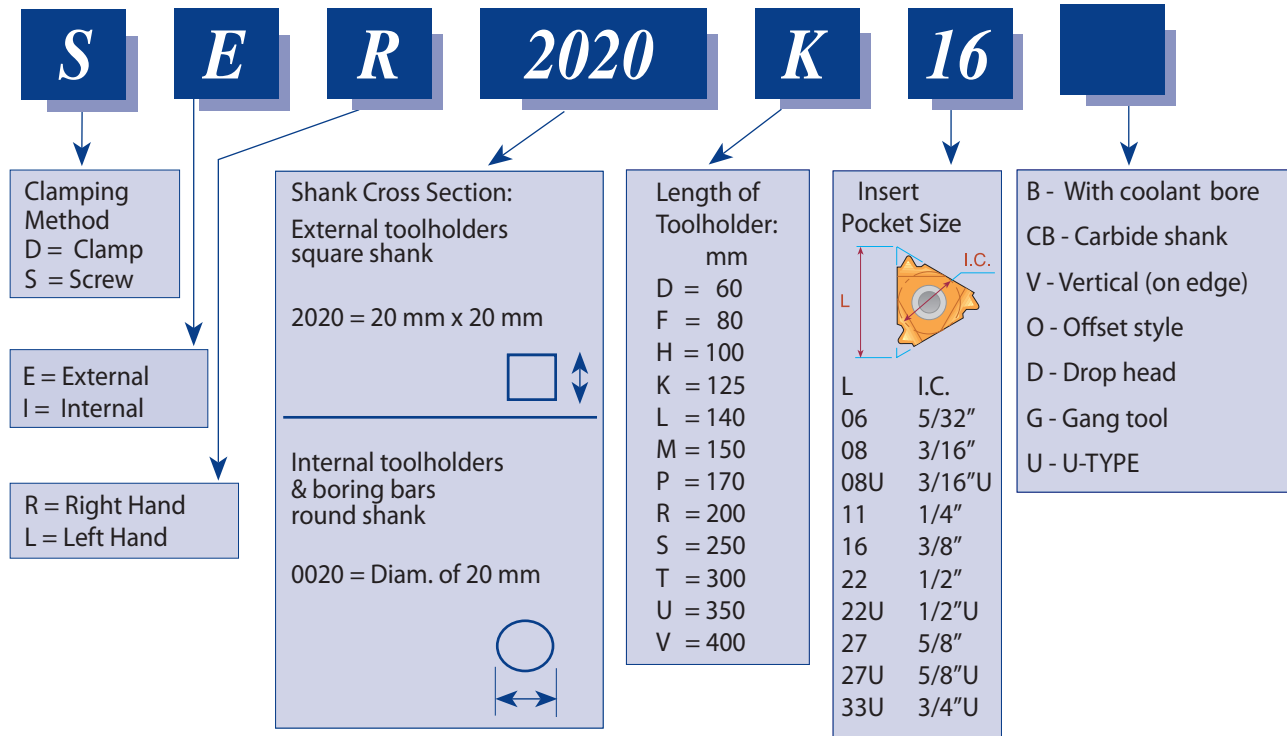

External Toolholders

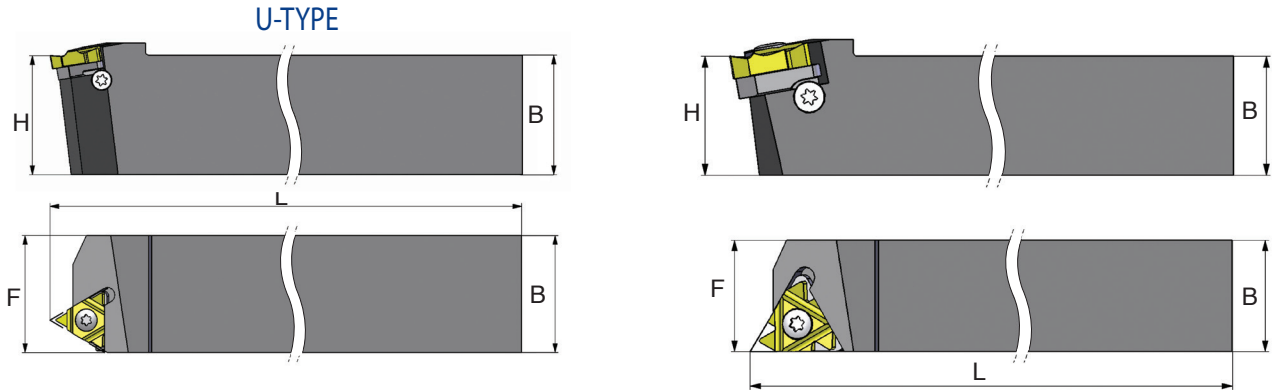

Ordering Code Right Hand	 L	B=H	L	F	Insert Screw	Anvil Screw	Torx Key	RH Anvil	LH Anvil
*SER 8 8 H11	11	8	100	11	S11	-	K11	-	-
*SER 1010 H11	11	10	100	11	S11	-	K11	-	-
*SER 1010 M11	11	10	150	11	S11	-	K11	-	-
*SER 1212 K11	11	12	125	12	S11	-	K11	-	-
*SER 1212 M11	11	12	150	12	S11	-	K11	-	-
SER 1212 F16	16	12	80	16	S16	A16	K16	AE16	AI16
SER 1616 H16	16	16	100	16	S16	A16	K16	AE16	AI16
SER 2020 K16	16	20	125	20	S16	A16	K16	AE16	AI16
SER 2525 M16	16	25	150	25	S16	A16	K16	AE16	AI16
SER 3232 P16	16	32	170	32	S16	A16	K16	AE16	AI16
SER 2525 M22	22	25	150	25	S22	A22	K22	AE22	AI22
SER 3232 P22	22	32	170	32	S22	A22	K22	AE22	AI22
SER 4040 R22	22	40	200	40	S22	A22	K22	AE22	AI22
SER 2525 M22U	22U	25	150	28	S22	A22	K22	AE22U	AI22U
SER 3232 P22U	22U	32	170	32	S22	A22	K22	AE22U	AI22U
SER 4040 R22U	22U	40	200	40	S22	A22	K22	AE22U	AI22U
SER 2525 M27	27	25	150	32	S27	A27	K27	AE27	AI27
SER 3232 P27	27	32	170	32	S27	A27	K27	AE27	AI27
SER 4040 R27	27	40	200	40	S27	A27	K27	AE27	AI27
SER 2525 M27U	27U	25	150	32	S27	A27	K27	AE27U	AI27U
SER 3232 P27U	27U	32	170	32	S27	A27	K27	AE27U	AI27U
SER 4040 R27U	27U	40	200	40	S27	A27	K27	AE27U	AI27U
*SER 2525 M33U	33U	25	150	32	S33	-	K33	-	-
*SER 3232 P33U	33U	32	170	32	S33	-	K33	-	-

*Toolholders with no anvil

For **LEFT HAND** toolholders specify **SEL** instead of **SER**

Toolholders are made with a **1.5° Helix Angle**. For other Helix Angles please see helix angle chart (page A04-7) in the technical section of this catalog.

Off-Set Toolholders

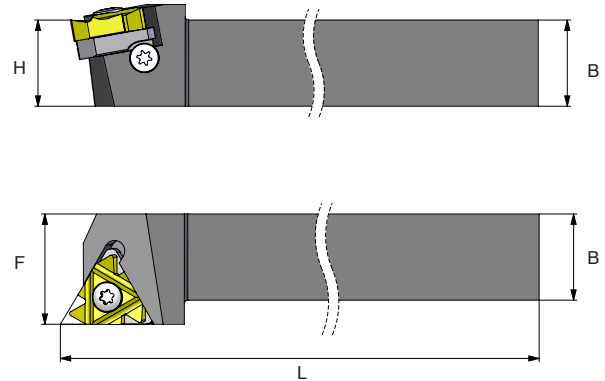



Ordering Code Right Hand	 L	B=H	L	F	Insert Screw	Anvil Screw	Torx Key	RH Anvil	LH Anvil
SER 1212 F16-O	16	12	8	16	S16	A16	K16	AE16	AI16
SER 1616 H16-O	16	16	100	20	S16	A16	K16	AE16	AI16
SER 2020 K16-O	16	20	125	25	S16	A16	K16	AE16	AI16
SER 2525 M16-O	16	25	150	32	S16	A16	K16	AE16	AI16
SER 3232 P16-O	16	32	170	40	S16	A16	K16	AE16	AI16
SER 2525 M22-O	22	25	150	32	S22	A22	K22	AE22	AI22
SER 3232 P22-O	22	32	170	40	S22	A22	K22	AE22	AI22

Thread Turning Toolholders

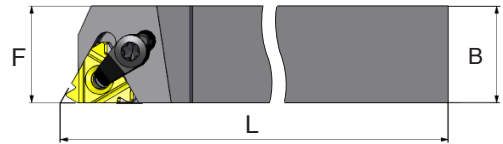

External Toolholders With Top Clamp



Ordering Code Right Hand	 L	B=H	L	F	Insert Screw	Clamp	Anvil Screw	Torx Key	RH Anvil	LH Anvil
DER 1212 H16	16	12	100	16	S16	C16	A16S	K16	AE16	AI16
DER 1616 H16	16	16	100	16	S16	C16	A16S	K16	AE16	AI16
DER 2020 K16	16	20	125	20	S16	C16	A16S	K16	AE16	AI16
DER 2525 M16	16	25	150	25	S16	C16	A16S	K16	AE16	AI16
*DER 2525 M22	22	25	150	25	S22	C22	A22	K22	AE22	AI22

For **LEFT HAND** toolholders specify **DEL** instead of **DER**
 Toolholders are made with a **1.5° Helix Angle**. For other Helix Angles
 please see helix angle chart in the technical section of this catalog.
 Two clamping methods can be used: screw or top clamp.
 *Use K21 torx key for C22 clamp

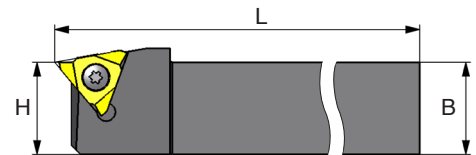

Vertical Toolholders



Ordering Code Right Hand	 L	B=H	L	F	Insert Screw	Torx Key
SER 1616 H16V	16	16	100	18	S16S	K16
SER 2020 K16V	16	20	125	22	S16S	K16
SER 2525 M16V	16	25	150	27	S16S	K16
SER 2525 M22V	22	25	150	27.5	S22S	K22
SER 3232 P27V-T10	27	32	170	36	S27	K27

Slim Throat Toolholders



Ordering Code Right Hand	 L	B=H	L	F	Insert Screw	Torx Key
SER 1616 H16VS	16	16	100	18	S16S	K16
SER 2020 K16VS	16	20	125	22	S16S	K16
SER 2525 M16VS	16	25	150	27	S16S	K16
SER 2525 M22VS	22	25	150	27	S22S	K22

Drophead Toolholders

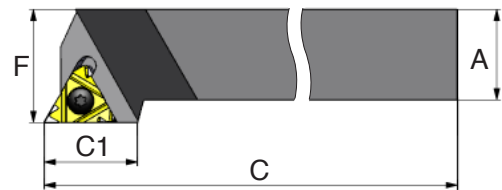
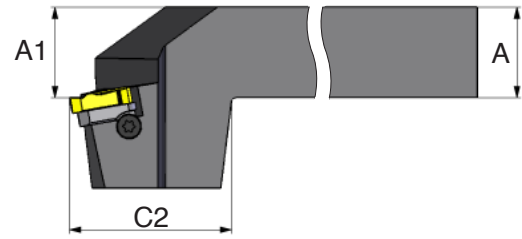

Ordering Code Right Hand	 L	A	A1	C	C1	F	C2	Insert Screw	Anvil Screw	Torx Key	RH Anvil	LH Anvil
SER 2020 K16D	16	20	20	125	21.0	25	38	S16	A16	K16	AE16	AI16
SER 2525 M16D	16	25	25	150	21.0	32	38	S16	A16	K16	AE16	AI16
SER 2525 M22D	22	25	25	150	21.0	32	38	S22	A22	K22	AE22	AI22

Gang Toolholders

Gang Toolholders are External Holders, used in small automatic machines with a gang tool post.

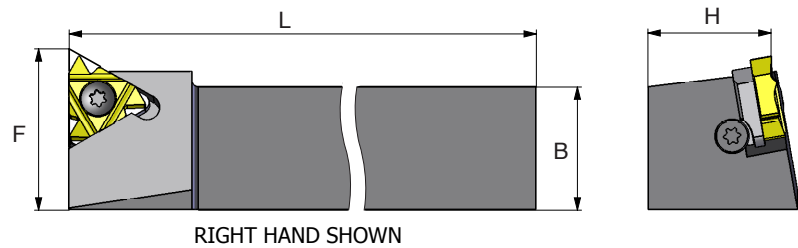
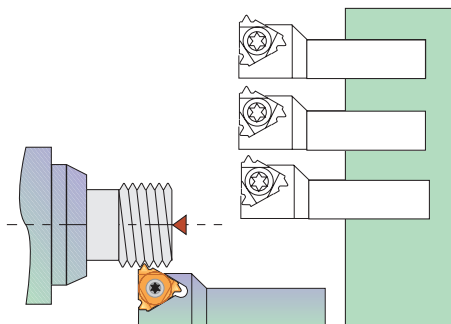

Ordering Code Right Hand	 L	B=H	L	F	Insert Screw	Anvil Screw	Torx Key	RH Anvil	LH Anvil
*SER 8 8 H11G	11	8	100	12.0	S11	-	K11	-	-
*SER 1010 H11G	11	10	100	14.0	S11	-	K11	-	-
SER 1616 K16G	16	16	125	21.7	S16	A16	K16	AE16	AI16
SER 2020 K16G	16	20	125	26.2	S16	A16	K16	AE16	AI16

*Toolholders with no anvil

For **LEFT HAND** toolholders specify **SEL** instead of **SER**

x-tream Jet External Toolholder with Internal Coolant

CPT has developed a unique external thread turning holder with internal coolant to the cutting edge.

The holder includes two connecting options through an elbow fitting and a top clamp directing the coolant flow to the cutting edge.

The coolant flow provides:

- Better chip control and chip flow
- Longer tool life and high performance
- Reduces the cutting edge temperature
- Available RH and LH toolholders
- Coated holders provide abrasive resistance

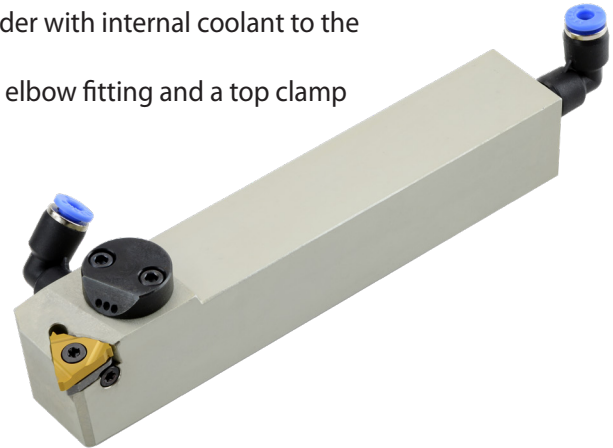

Demonstration

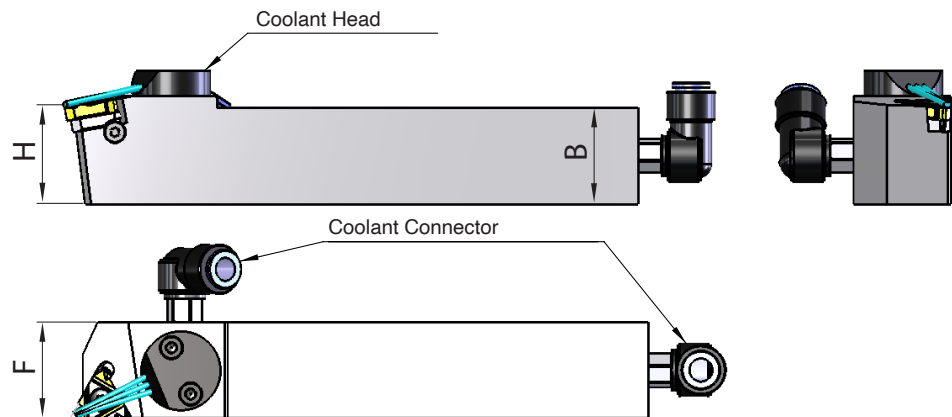

Ordering Code	 L mm	B=H	L	F	Insert Screw Torx +	Anvil Screw Torx +	Key Torx +	RH Anvil	LH Anvil	Coolant head	Coolant* Connector mm
SER 1616 H16B	16	16	100	16	S16P	A16P	K16P	AE16	AI16	CH3	Ø4/Ø6
SER 2020 K16B	16	20	125	20	S16P	A16P	K16P	AE16	AI16	CH1	Ø4/Ø6
SER 2525 M16B	16	25	150	25	S16P	A16P	K16P	AE16	AI16	CH1	Ø4/Ø6
SER 2525 M22B	22	25	150	25	S22P	A22P	K22P	AE22	AI22	CH1	Ø4/Ø6
SER 2525 M27B	27	25	150	32	S27P	A27P	K27P	AE27	AI27	CH1	Ø4/Ø6
SER 3232 P16B	16	32	170	32	S16P	A16P	K16P	AE16	AI16	CH1	Ø4/Ø6
SER 3232 P22B	22	32	170	32	S22P	A22P	K22P	AE22	AI22	CH1	Ø4/Ø6
SER 3232 P27B	27	32	170	32	S27P	A27P	K27P	AE27	AI27	CH1	Ø4/Ø6

For **LEFT HAND** toolholders specify **SEL** instead of **SER**

Toolholders made with 1.5° helix angle

Please consult the helix angle chart page A04-7 in the technical section of this catalog

* Standard packing with Ø6 mm

Internal Toolholders

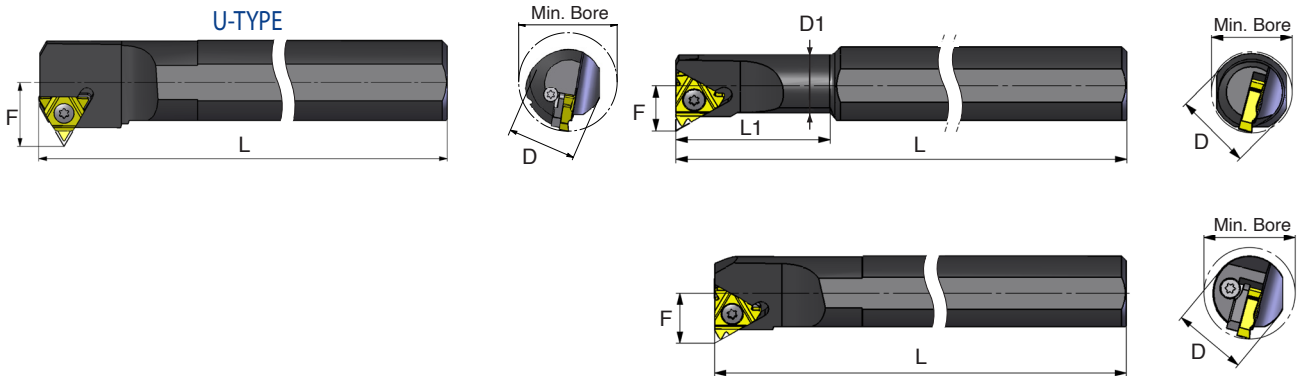

Ordering Code Right Hand		D	D1	Min Bore Diam.	L	L1	F	Insert Screw	Anvil Screw	Torx Key	RH Anvil	LH Anvil
*SIR 0005 H06	6	12	5.1	6.0	100	12	4.3	S06	-	K06	-	-
*SIR 0007 K08	8	16	6.6	7.8	125	18	5.3	S08	-	K08	-	-
*SIR 0008 K08U	8U	16	7.3	9.0	125	21	6.6	S08	-	K08	-	-
*SIR 0010 H11	11	10	10	12	100	-	7.4	S11	-	K11	-	-
*SIR 0010 K11	11	16	10	12	125	25	7.4	S11	-	K11	-	-
*SIR 0013 L11	11	16	13	15	140	32	8.9	S11	-	K11	-	-
*SIR 0013 M16	16	16	13	16	150	32	10.2	S16S	-	K16	-	-
*SIR 0016 P16	16	20	16	19	170	40	11.7	S16S	-	K16	-	-
SIR 0020 P16	16	20	20	24	170	-	13.7	S16	A16	K16	AI16	AE16
SIR 0025 R16	16	25	25	29	200	-	16.2	S16	A16	K16	AI16	AE16
SIR 0032 S16	16	32	32	36	250	-	19.7	S16	A16	K16	AI16	AE16
SIR 0040 T16	16	40	40	44	300	-	23.7	S16	A16	K16	AI16	AE16
SIR 0050 U16	16	50	50	54	350	-	28.7	S16	A16	K16	AI16	AE16
*SIR 0020 P22	22	20	20	24	170	-	15.6	S22S	-	K22	-	-
SIR 0025 R22	22	25	25	29	200	-	18.1	S22	A22	K22	AI22	AE22
SIR 0032 S22	22	32	32	38	250	-	21.6	S22	A22	K22	AI22	AE22
SIR 0040 T22	22	40	40	46	300	-	25.6	S22	A22	K22	AI22	AE22
SIR 0050 U22	22	50	50	56	350	-	30.6	S22	A22	K22	AI22	AE22
SIR 0032 S22U	22U	32	32	38	250	-	24.4	S22	A22	K22	AI22U	AE22U
SIR 0040 T22U	22U	40	40	46	300	-	28.1	S22	A22	K22	AI22U	AE22U
SIR 0050 U22U	22U	50	50	57	350	-	30.8	S22	A22	K22	AI22U	AE22U
SIR 0032 S27	27	32	32	40	250	-	22.6	S27	A27	K27	AI27	AE27
SIR 0040 T27	27	40	40	48	300	-	26.6	S27	A27	K27	AI27	AE27
SIR 0050 U27	27	50	50	58	350	-	31.6	S27	A27	K27	AI27	AE27
SIR 0060 V27	27	60	60	68	400	-	36.6	S27	A27	K27	AI27	AE27
SIR 0032 S27U	27U	32	32	40	250	-	25.8	S27	A27	K27	AI27U	AE27U
SIR 0040 T27U	27U	40	40	48	300	-	29.4	S27	A27	K27	AI27U	AE27U
SIR 0050 U27U	27U	50	50	58	350	-	34.4	S27	A27	K27	AI27U	AE27U
SIR 0060 V27U	27U	60	60	68	400	-	39.7	S27	A27	K27	AI27U	AE27U
*SIR 0050 U33U	33U	50	50	62	350	-	37.5	S33	-	K33	-	-

*Toolholders without anvil

For **LEFT HAND** toolholders specify **SIL** instead of **SIR**

Toolholders are made with a **1.5° Helix Angle**. For other Helix Angles please see helix angle chart (page A04-7) in the technical section of this catalog.

For "U" type inserts Tr, Acme, Stub Acme, see our software or contact main office for holder use.

Internal Toolholders with Coolant Bore

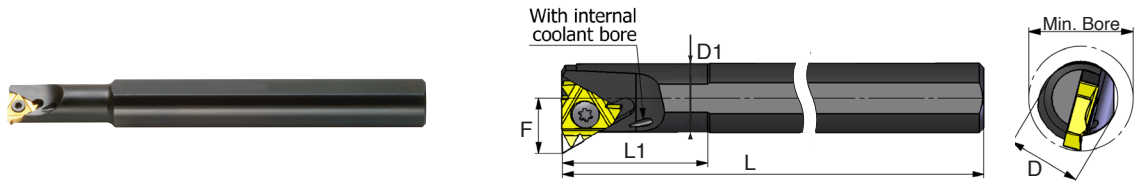

Ordering Code Right Hand	 L	D	D1	Min Bore Diam.	L	L1	F	Insert Screw	Anvil Screw	Torx Key	RH Anvil	LH Anvil
*SIR 0010 K11B	11	16	10	12	125	25	7.4	S11	-	K11	-	-
*SIR 0013 M16B	16	16	13	16	150	32	10.2	S16S	-	K16	-	-
*SIR 0016 P16B	16	20	16	19	170	40	11.7	S16S	-	K16	-	-
SIR 0020 P16B	16	20	20	24	170	-	13.7	S16	A16	K16	AI16	AE16
SIR 0025 R16B	16	25	25	29	200	-	16.2	S16	A16	K16	AI16	AE16
SIR 0025 R22B	22	25	25	29	200	-	18.1	S22	A22	K22	AI22	AE22
SIR 0032 S16B	16	32	32	36	250	-	19.7	S16	A16	K16	AI16	AE16

*Toolholders without anvil

For **LEFT HAND** toolholders specify **SIL** instead of **SIR**

Toolholders are made with a **1.5° Helix Angle**. For other Helix Angles please see helix angle chart (page A04-7) in the technical section of this catalog.

Internal Toolholders with Top Clamp

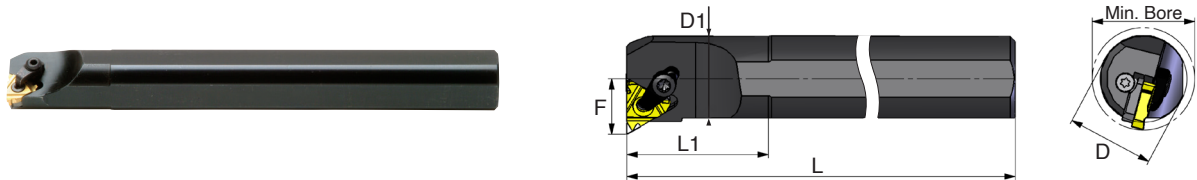

Ordering Code Right Hand	 L	D	D1	Min Bore Diam.	L	L1	F	Insert Screw	Clamp	Anvil Screw	Torx Key	RH Anvil	LH Anvil
DIR 0020 P16	16	20	20	24	170	-	13.7	S16	C16	A16S	K16	AI16	AE16
DIR 0025 R16	16	25	25	29	200	-	16.2	S16	C16	A16S	K16	AI16	AE16
DIR 0032 S16	16	32	32	36	250	-	19.7	S16	C16	A16S	K16	AI16	AE16
* DIR 0025 R22	22	25	25	29	200	-	18.1	S22	C22	A22	K22	AI22	AE22

For **LEFT HAND** toolholders specify **DIL** instead of **DIR**

Two clamping methods can be used: screw or top clamp.

*Use K21 torx key for C22 clamp

Toolholders with 3.5° Helix Angle

Ordering Code Right Hand	 L	D	D1	Min Bore Diam. mm	L	L1	F	Insert Screw	Torx Key
SIR 0016 P16B-3.5	16	20	16	19	170	40	13.7	S16S	K16
SIR 0020 P22B-3.5	22	20	20	24	170	-	15.6	S22S	K22

For **LEFT HAND** toolholders specify **SIL** instead of **SIR**

Special Thread Turning Applications

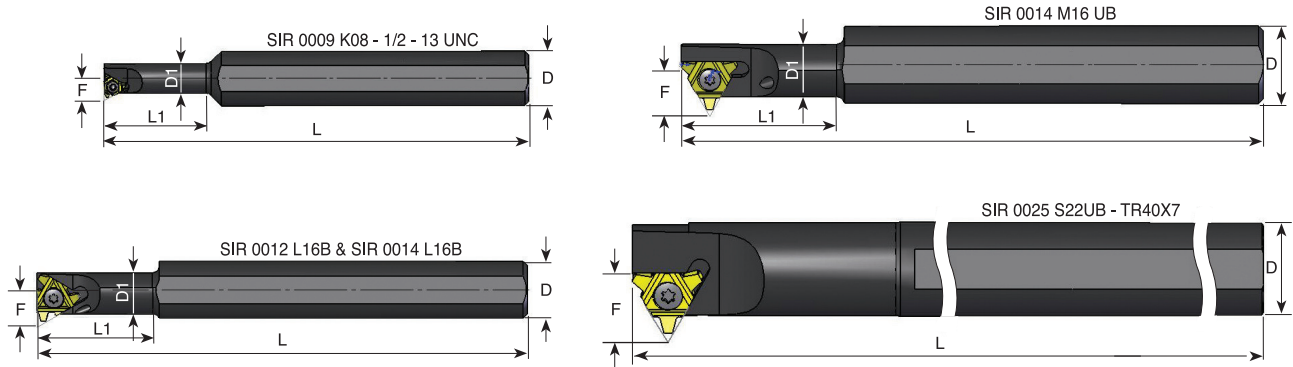

Ordering Code Right Hand		D	D1	L	L1	F	Thread	Insert Screw	Torx Key
*SIR 0009 K08	8	16	8.7	125	30	6.5	1/2 - 13UNC	S08	K08
SIR 0012 L16B	16	20	11.5	140	33	10.5	TR18x4	S16S	K16
SIR 0014 L16B	16	20	12.5	140	36	21.1	TR20x4	S16S	K16
SIR 0014 M16UB	16	20	13.5	150	40	13.2	TR22x5	S16S	K16
SIR 0025 S22UB	22	25	-	250		19.5	TR40x7	S22S	K22

For LH holders call CPT

* Only right hand available

Carbide Shank Threading Bars With coolant bore

Carbide Shank Threading Bars are used when chatter and deflection are expected due to long overhang in deep small bores.

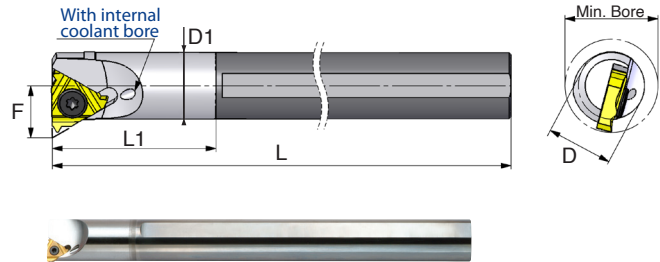

Ordering Code Right Hand	 L	D	D1	Min Bore Diam.	L	L1	F	Insert Screw	Anvil Screw	Torx Key	RH Anvil	LH Anvil
SIR 0005 H06CB	6	6	5.1	6.0	100	26	4.3	S06	-	K06	-	-
SIR 0007 K08CB	8	8	6.6	7.8	125	31	5.3	S08	-	K08	-	-
SIR 0008 K08UCB	8U	8	7.3	9.0	125	35	6.6	S08	-	K08	-	-
SIR 0010 M11CB	11	10	10	12	150	-	7.4	S11	-	K11	-	-
SIR 0012 P11CB	11	12	12	15	170	-	8.4	S11	-	K11	-	-
SIR 0016 R16CB	16	16	16	19	200	-	11.7	S16S	-	K16	-	-
*SIR 0020 S16CB	16	20	20	24	250	-	13.7	S16	A16	K16	AI16	AE16
*SIR 0025 S16CB	16	25	25	29	250	-	16.2	S16	A16	K16	AI16	AE16
**SIR 0020 S22CB	22	20	19.3	24	250	100	15.6	S22	-	K22	-	-

* Carbide shank threading bars with anvil

** Helix angle: 3.5°

For **LEFT HAND** toolholders specify **SIL** instead of **SIR**

Vertical Toolholders

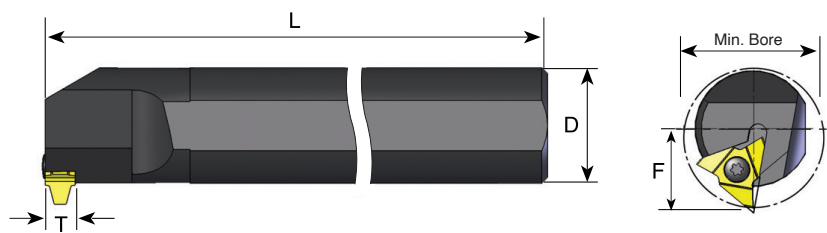



Ordering Code Right Hand	 L	D	* Min Bore Diam.	L	F	Insert Screw	Torx Key
SIR 0040T27V-T10	27	40	48	300	29	S27	K27
SIR 0050U27V-T10	27	50	58	350	34	S27	K27

* To be compared with given minimum bore profile.

For **LEFT HAND** toolholders specify **SIL** instead of **SIR**

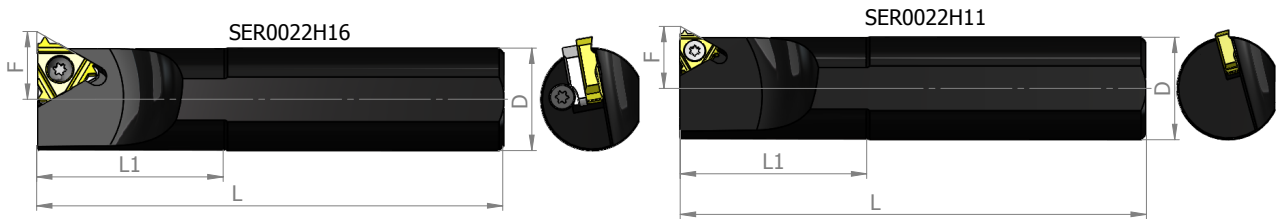
Star Toolholders Ø22



Ordering Code Right Hand		D	L	L1	F	Insert Screw	Anvil Screw	Torx Key	RH Anvil	LH Anvil
SER 0022 H11	11	22	100	40	13.3	S11	-	K11	-	-
SER 0022 H16	16	22	100	40	14.6	S16	A16	K16	AE16	AI16

For **LEFT HAND** toolholders specify **SEL** instead of **SER**

Modular Line

Turning adaptors and boring bars
for internal applications of threading and grooving.



Advantages

- High accurate turning ML adaptors provide full flexibility and easy adjustment.
- Full repeatability.
- A single boring bar fits to multi ML adaptors.
- Reduces tool inventories - investing in a single boring bar, right and left hand ML adaptors from the same size.
- ML adaptors support all CPT standard thread turning inserts sizes 16, 22 and 27 mm. Grooving inserts size 16 mm fit the MLR/L 16 - 32 and MLR / L 16 - 40 adaptors.
- ML adaptors are coated with a high abrasive resistant nickel layer to prolong the ML adaptors tool life.

Applications

- Internal machining
- Deep threads require high overhang with maximum rigidity
- Grooving
- Can be used on a large range of turning or multi-task machines

High pressure coolant

ML boring bars and adaptors are designed with internal coolant allowing high pressure up to 120 bar.

High pressure coolant reduces the cutting edge temperature, provides a better chip evacuation and improves tool life.

The tools can also be used with normal coolant pressure.

Applications

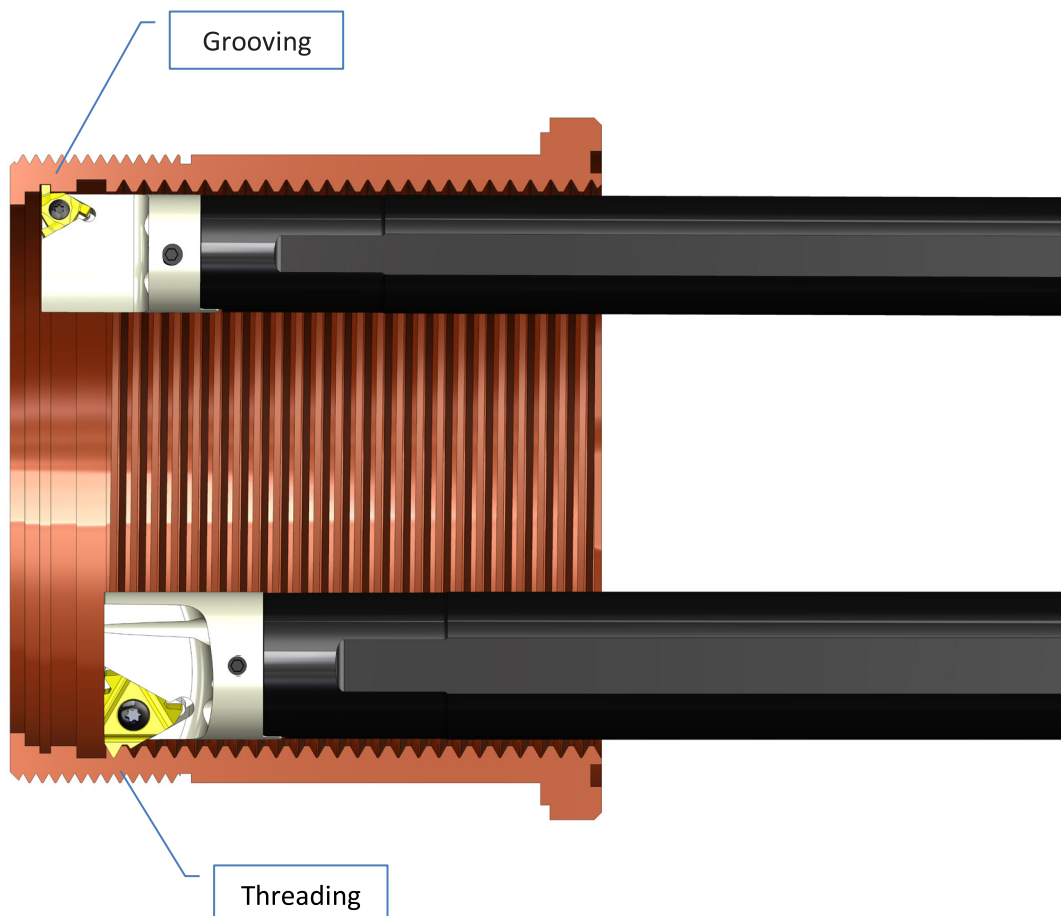

- Maximum overhang: 4 x D

Product Identification

ML Turning adaptors

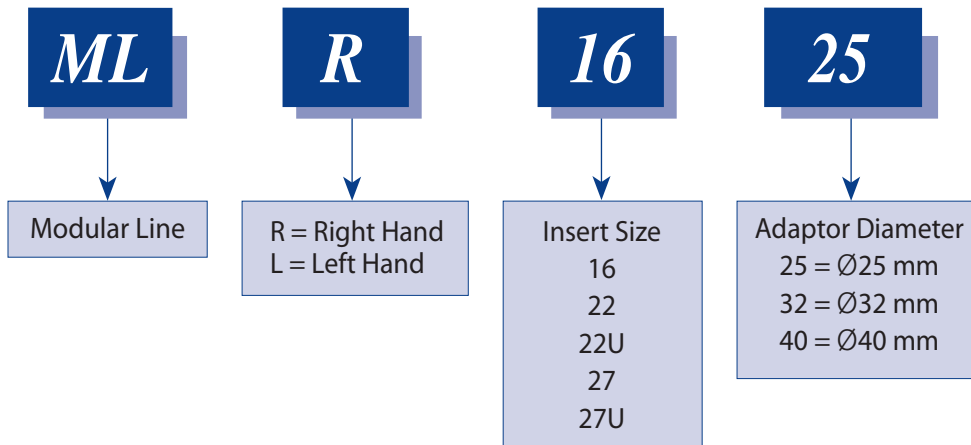

Boring Bars

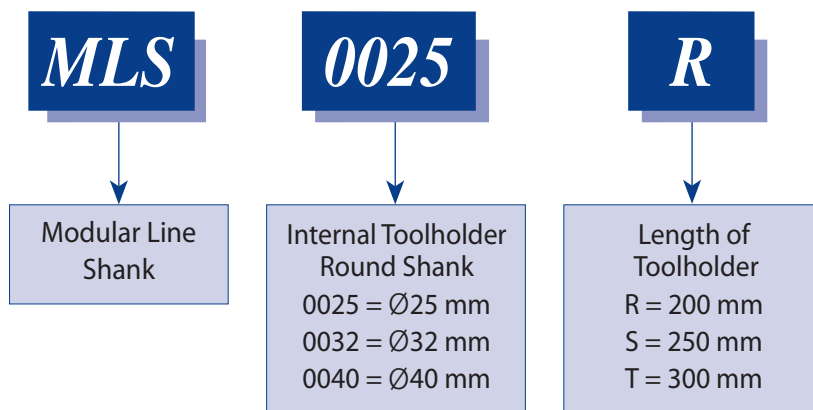

ML Turning Adaptors

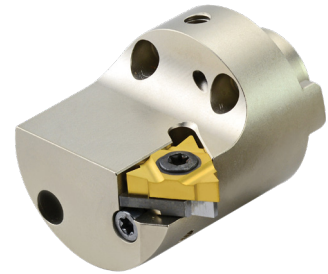
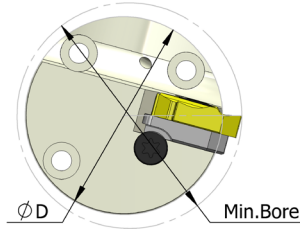
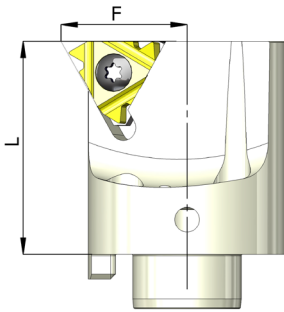

D	Ordering Code	 L	I.C. in	Min Bore Diam.	L	F	Insert Screw	Anvil Screw	Torx Key	RH Anvil	LH Anvil
25	*MLR 16 - 25	16	3/8	29	30	16.2	S16P	-	K16P	-	-
25	*MLR 22 - 25	22	1/2	29	30	18.1	S22P	-	K22P	-	-
32	MLR 16 - 32	16	3/8	36	43	19.7	S16P	A16P	K16P	AI16	AE16
32	MLR 22 - 32	22	1/2	38	43	21.6	S22P	A22P	K22P	AI22	AE22
32	MLR 22U - 32	22U	1/2U	38	43	24.4	S22P	A22P	K22P	AI22U	AE22U
40	MLR 16 - 40	16	3/8	44	43	23.7	S16P	A16P	K16P	AI16	AE16
40	MLR 22 - 40	22	1/2	46	43	25.6	S22P	A22P	K22P	AI22	AE22
40	MLR 22U - 40	22U	1/2U	46	43	28.1	S22P	A22P	K22P	AI22	AE22
40	MLR 27 - 40	27	5/8	48	43	26.6	S27P	A27P	K27P	AI27	AE27
40	MLR 27U - 40	27U	5/8U	48	43	29.4	S27P	A27P	K27P	AI27U	AE27U

*Toolholders with no anvil

For **LEFT HAND** toolholders specify **MLL** instead of **MLR**

Boring Bars

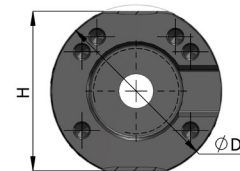
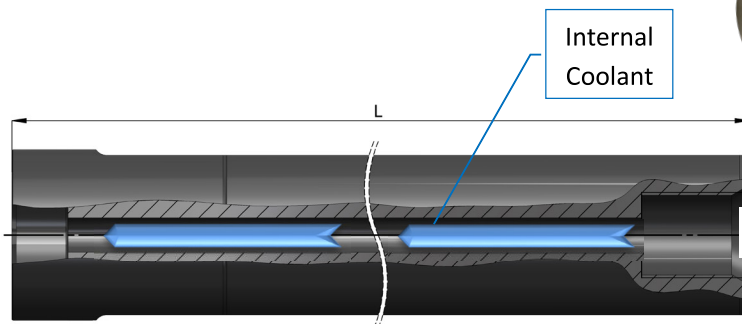

D	Ordering Code	L	H	C	Screw	Key
25	MLS 0025 R	200	23	G1/4"	S420, S435	K3
32	MLS 0032 S	250	30	G3/8"	S520, S550	K4
40	MLS 0040 T	300	36	G1/2"	S520, S550	K4

External ML adaptors (for external threads) are available upon request and can be used on the same MLS boring bars.

Quick Change Polygon Threading Toolholders

- Polygon shank
- ISO standard (26623) compliant for toolholding systems
- Polygon taper ensures automatic radial centering and even pressure around the coupling
- Enable quick tool changes ISO standard coupling system with a 1.4 degree tapered polygon shank design
- Interchangeable with leading manufacturers

External Toolholders

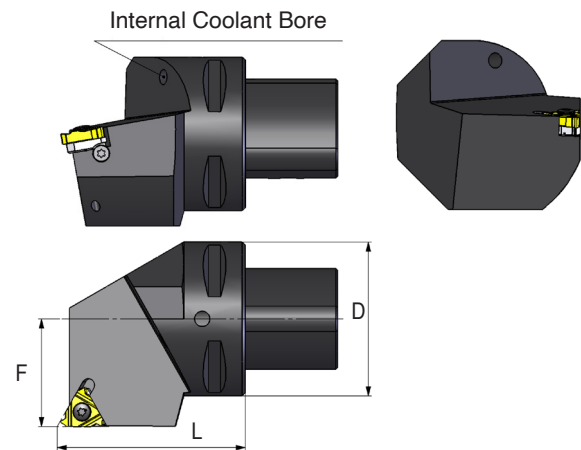

Equivalent to...	Ordering Code		D	F	L	Insert Screw	Anvil Screw	Torx key	RH Anvil	LH Anvil
C4	P40-SER 27050-16	16	40	27	50	S16	A16	K16	AE16	AI16
C5	P50-SER 35060-16	16	50	35	60	S16	A16	K16	AE16	AI16
C6	P63-SER 45065-16	16	63	45	65	S16	A16	K16	AE16	AI16
C4	P40-SER 27050-22	22	40	27	50	S22	A22	K22	AE22	AI22
C5	P50-SER 35060-22	22	50	35	60	S22	A22	K22	AE22	AI22
C6	P63-SER 45065-22	22	63	45	65	S22	A22	K22	AE22	AI22
C8	P80-SER 55080-16	16	80	55	80	S16	A16	K16	AE16	AI16
C8	P80-SER 55080-22	22	80	55	80	S22	A22	K22	AE22	AI22
C6	P63-SER 45065-27	27	63	45	65	S27	A27	K27	AE27	AI27

For **LEFT HAND** toolholders specify **SEL** instead of **SER**

Internal Toolholders

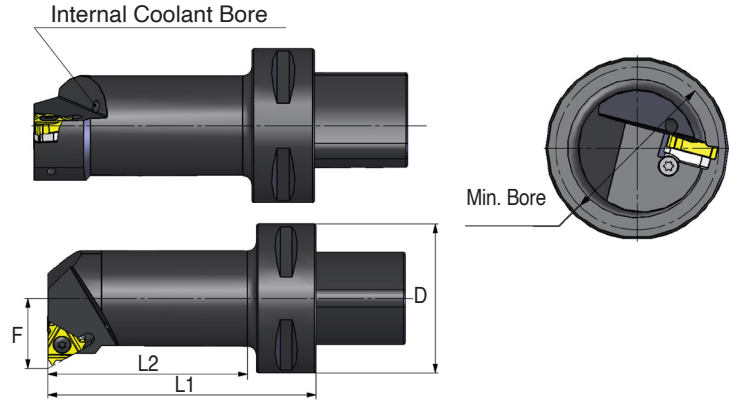

Equivalent to...	Ordering Code		D	F	Min. Bore Dia.	L1	L2	Insert Screw	Anvil Screw	Torx key	RH Anvil	LH Anvil
C4	* P40-SIR 12060-16	16	40	11.7	20	60	37	S16	-	K16	-	-
	P40-SIR 14060-16	16	40	13.5	25	60	38	S16	A16	K16	AI16	AE16
	P40-SIR 17070-16	16	40	16.0	29	70	48	S16	A16	K16	AI16	AE16
	P40-SIR 22090-16	16	40	19.5	36	90	69	S16	A16	K16	AI16	AE16
	P40-SIR 27080-16	16	40	23.5	44	80	60	S16	A16	K16	AI16	AE16
C5	* P50-SIR 12060-16	16	50	11.7	20	60	35	S16	-	K16	-	-
	P50-SIR 14060-16	16	50	13.5	25	60	36	S16	A16	K16	AI16	AE16
	P50-SIR 17070-16	16	50	16.0	29	70	47	S16	A16	K16	AI16	AE16
	P50-SIR 22090-16	16	50	19.5	36	90	68	S16	A16	K16	AI16	AE16
	P50-SIR 27105-16	16	50	23.5	44	105	84	S16	A16	K16	AI16	AE16
C6	P63-SIR 14070-16	16	63	13.5	25	70	42	S16	A16	K16	AI16	AE16
	P63-SIR 17075-16	16	63	16.0	29	75	48	S16	A16	K16	AI16	AE16
	P63-SIR 22090-16	16	63	19.5	36	90	64	S16	A16	K16	AI16	AE16
	P63-SIR 27105-16	16	63	23.5	44	105	80	S16	A16	K16	AI16	AE16
C4	* P40-SIR 15065-22	22	40	15.4	25	65	42	S22	-	K22	-	-
	P40-SIR 19070-22	22	40	17.9	29	70	48	S22	A22	K22	AI22	AE22
	P40-SIR 22090-22	22	40	21.4	38	90	69	S22	A22	K22	AI22	AE22
	P40-SIR 27080-22	22	40	25.4	46	80	60	S22	A22	K22	AI22	AE22
C5	* P50-SIR 15065-22	22	50	15.4	25	65	41	S22	-	K22	-	-
	P50-SIR 19070-22	22	50	17.9	29	70	47	S22	A22	K22	AI22	AE22
	P50-SIR 22090-22	22	50	21.4	38	90	68	S22	A22	K22	AI22	AE22
	P50-SIR 27105-22	22	50	25.4	46	105	84	S22	A22	K22	AI22	AE22
C6	P63-SIR 19075-22	22	63	17.9	29	75	48	S22	A22	K22	AI22	AE22
	P63-SIR 22090-22	22	63	21.4	38	90	64	S22	A22	K22	AI22	AE22
	P63-SIR 27105-22	22	63	25.4	46	105	80	S22	A22	K22	AI22	AE22

For **LEFT HAND** toolholders specify **SIL** instead of **SIR**

* Holders without anvil

Thread Helix Angle

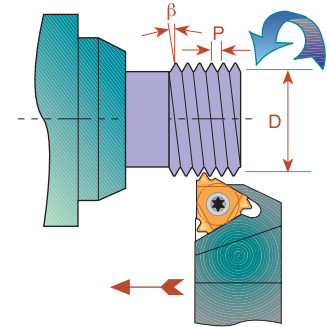
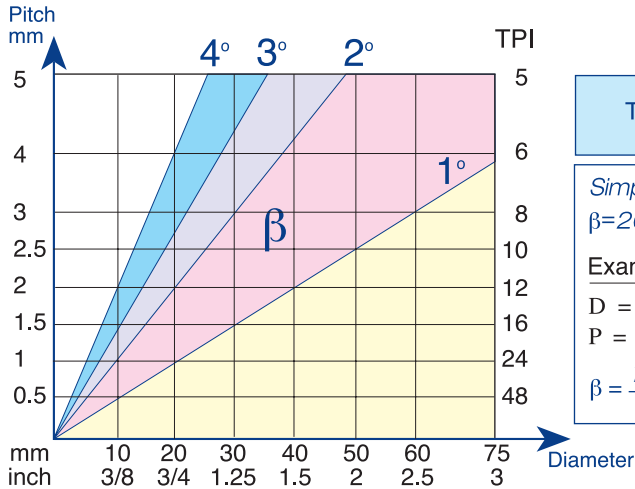

Standard and Slanted Anvils

CPT Toolholder Pockets have a built in 1.5° helix angle. This angle may be adjusted to better match the thread helix angle by simply changing the anvil.

Negative helix is usually used when threading RH thread with LH Holder or LH thread with RH Holder.

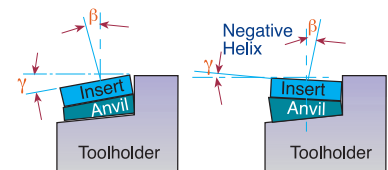

L	IC	Pocket Angle γ	4.5°	3.5°	2.5°	1.5° Standard	0.5°	-0.5°	-1.5°
16	3/8	EX-RH OR IN-LH	AE16+4.5	AE16+3.5	AE16+2.5	AE16	AE16+0.5	AE16-0.5	AE16-1.5
16	3/8	EX-LH OR IN-RH	AI 16+4.5	AI 16+3.5	AI 16+2.5	AI 16	AI 16+0.5	AI 16-0.5	AI 16-1.5
22	1/2	EX-RH OR IN-LH	AE22+4.5	AE22+3.5	AE22+2.5	AE22	AE22+0.5	AE22-0.5	AE22-1.5
22	1/2	EX-LH OR IN-RH	AI 22+4.5	AI 22+3.5	AI 22+2.5	AI 22	AI 22+0.5	AI 22-0.5	AI 22-1.5
22U	1/2U	EX-RH OR IN-LH	AE22U+4.5	AE22U+3.5	AE22U+2.5	AE22U	AE22U+0.5	AE22U-0.5	AE22U-1.5
22U	1/2U	EX-LH OR IN-RH	AI 22U+4.5	AI 22U+3.5	AI 22U+2.5	AI 22U	AI 22U+0.5	AI 22U-0.5	AI 22U-1.5
27	5/8	EX-RH OR IN-LH	AE27+4.5	AE27+3.5	AE27+2.5	AE27	AE27+0.5	AE27-0.5	AE27-1.5
27	5/8	EX-LH OR IN-RH	AI 27+4.5	AI 27+3.5	AI 27+2.5	AI 27	AI 27+0.5	AI 27-0.5	AI 27-1.5
27U	5/8U	EX-RH OR IN-LH	AE27U+4.5	AE27U+3.5	AE27U+2.5	AE27U	AE27U+0.5	AE27U-0.5	AE27U-1.5
27U	5/8U	EX-LH OR IN-RH	AI 27U+4.5	AI 27U+3.5	AI 27U+2.5	AI 27U	AI 27U+0.5	AI 27U-0.5	AI 27U-1.5

Anvil Kits

5 AE and 5 AI anvils with various helix angles



AE (FOR EX.RH. & IN.LH.)



AI (FOR IN.RH. & EX.LH.)



Ordering Code	Contents				
KA16	AE16+4.5 AI 16+4.5	AE16+3.5 AI 16+3.5	AE16+2.5 AI 16+2.5	AE16+0.5 AI 16+0.5	AE16-1.5 AI 16-1.5
KA22	AE22+4.5 AI 22+4.5	AE22+3.5 AI 22+3.5	AE22+2.5 AI 22+2.5	AE22+0.5 AI 22+0.5	AE22-1.5 AI 22-1.5
KA22U	AE22U+4.5 AI 22U+4.5	AE22U+3.5 AI 22U+3.5	AE22U+2.5 AI 22U+2.5	AE22U+0.5 AI 22U+0.5	AE22U-1.5 AI 22U-1.5
KA27	AE27+4.5 AI 27+4.5		AE27+2.5 AI 27+2.5		AE27-1.5 AI 27-1.5
KA27U	AE27U+4.5 AI 27U+4.5		AE27U+2.5 AI 27U+2.5		AE27U-1.5 AI 27U-1.5

Standard Kits

Threading Kits are a versatile solution for users that cut a variety of thread types in limited quantity and do not want to sacrifice thread quality.

External ISO Kit Ordering Code: KEG

INSERTS

16 ER A60 P25C
16 ER G60 P25C
16 ER 0.75 ISO P25C
16 ER 1.0 ISO P25C
16 ER 1.25 ISO P25C
16 ER 1.5 ISO P25C
16 ER 1.75 ISO P25C
16 ER 2.0 ISO P25C
16 ER 2.5 ISO P25C
16 ER 3.0 ISO P25C

TOOLHOLDERS

SER 2020 K16
KEY
K16
SCREW
S16

Internal ISO Kit Ordering Code: KIG

INSERTS

16 IR A60 P25C
16 IR G60 P25C
16 IR 0.75 ISO P25C
16 IR 1.0 ISO P25C
16 IR 1.25 ISO P25C
16 IR 1.5 ISO P25C
16 IR 1.75 ISO P25C
16 IR 2.0 ISO P25C
16 IR 2.5 ISO P25C
16 IR 3.0 ISO P25C

TOOLHOLDERS

SIR 0020 P16
KEY
K16
SCREW
S16



If a larger toolholder with a 25 mm shank is required, add to the kit 25. For example: KIG - 25
BMA grade is also available. For example: KEG - BMA

Miniature & Ultra-Miniature Kits



Ordering Code	Type	No. of Inserts	Inserts	Contents Boring Bar	Key
KU60M - BXC	ULTRA	10	06 IR A60 BXC	SIR 0005 H06	K6
KM60M - BXC	MINI	10	08 IR A60 BXC	SIR 0007 K08	K8

Inserts' Kits

Type B Kits

Type B threading inserts.
 A combination of ground profile and sintered chip-breaker threading inserts.
 BMA Grade: Sub-Micron carbide grade with TiAlN multi-layer Coating.

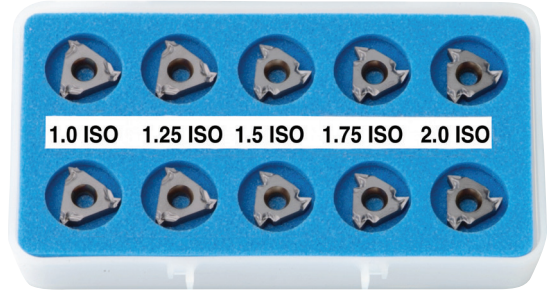

EXTERNAL ISO KIT KEMB - BMA

- 16 ER B 1.0 ISO BMA-2 Pcs
- 16 ER B 1.25 ISO BMA-2 Pcs
- 16 ER B 1.5 ISO BMA-2 Pcs
- 16 ER B 1.75 ISO BMA-2 Pcs
- 16 ER B 2.0 ISO BMA-2 Pcs

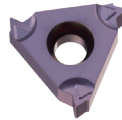

EX-RH

INTERNAL ISO KIT KIMB - BMA

- 16 IR B 1.0 ISO BMA-2 Pcs
- 16 IR B 1.25 ISO BMA-2 Pcs
- 16 IR B 1.5 ISO BMA-2 Pcs
- 16 IR B 1.75 ISO BMA-2 Pcs
- 16 IR B 2.0 ISO BMA-2 Pcs

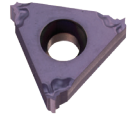

IN-RH

Standard Inserts' Kits

EXTERNAL ISO KIT

- 16 ER 1.0 ISO-2 Pcs
- 16 ER 1.25 ISO-2 Pcs
- 16 ER 1.5 ISO-2 Pcs
- 16 ER 1.75 ISO-2 Pcs
- 16 ER 2.0 ISO-2 Pcs

INTERNAL ISO KIT

- 16 IR 1.0 ISO-2 Pcs
- 16 IR 1.25 ISO-2 Pcs
- 16 IR 1.5 ISO-2 Pcs
- 16 IR 1.75 ISO-2 Pcs
- 16 IR 2.0 ISO-2 Pcs

Ordering Code: KEM

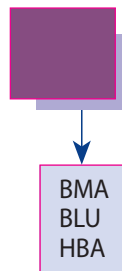

Ordering Code: KIM

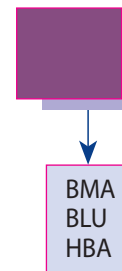

Threading & Boring Combination Kit

A practical and convenient combination kit for **Ultra Miniature** Threading and Boring. It enables Boring and Threading of mini bores as small as **6 mm diameter (1/4")** with just one deep reaching Carbide shank ultra mini Boring Bar.



Ordering Code	Contents			
	Threading Insert	Turning Inserts	Boring Bar	Key
KC6TM	06 IR A60 BXC 10 Pcs	06 IR TURN BMA 10 Pcs	SIR 0005 H06CB	K6

BMA - Coated carbide grade for medium to high cutting speeds

BXC - Coated carbide grade for low cutting speed - 40 to 90 m/min

CB - Carbide shank boring bar with coolant bore





Demonstration

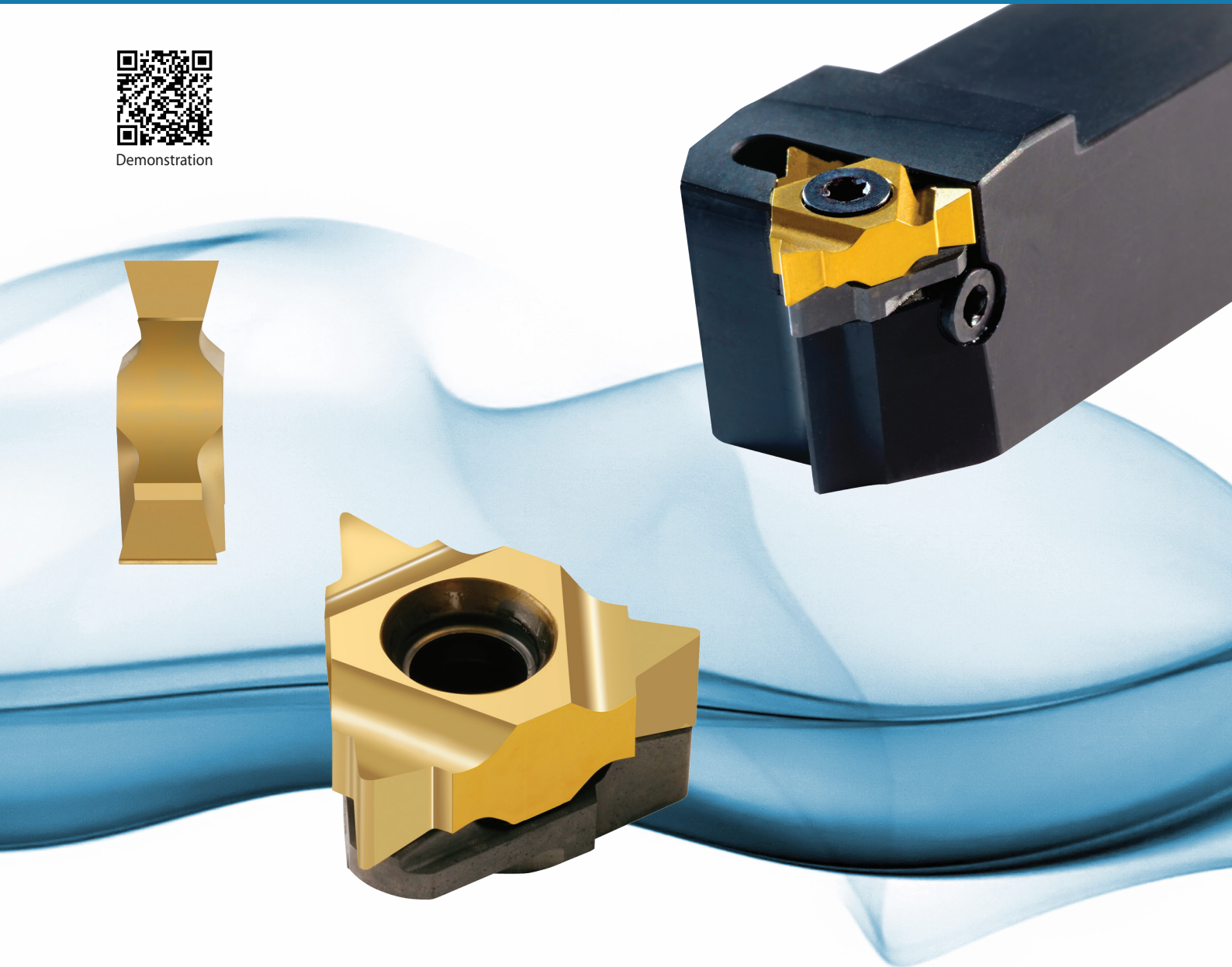

A unique line of 2 sided inserts including 6 cutting edges, a cost saving tool.

Advantages of DSI-Thread Turning Inserts

- Increased productivity thanks to the six cutting edges.
- U-Style inserts for a wide range of full or partial profile standard threads.
- Same insert for right hand or left hand thread.
- Saving on tooling costs.
- Unique anti-vibration anvil designed for clamping the insert and supporting the cutting edge.
- Simple insert's mounting and cutting edge indexing.
- Heavy duty toolholders designed specially for this line.

Contents:

Page:

Product Identification	2
Partial Profile 60°	3
Partial Profile 55°	3
ISO	4
UN	4

Contents:

Page:

Whitworth 55°	5
NPT	5
Heavy Duty Thread Turning Toolholders - External	6
Heavy Duty Thread Turning Toolholders - Internal	6

Product Identification

DSI Ordering Code

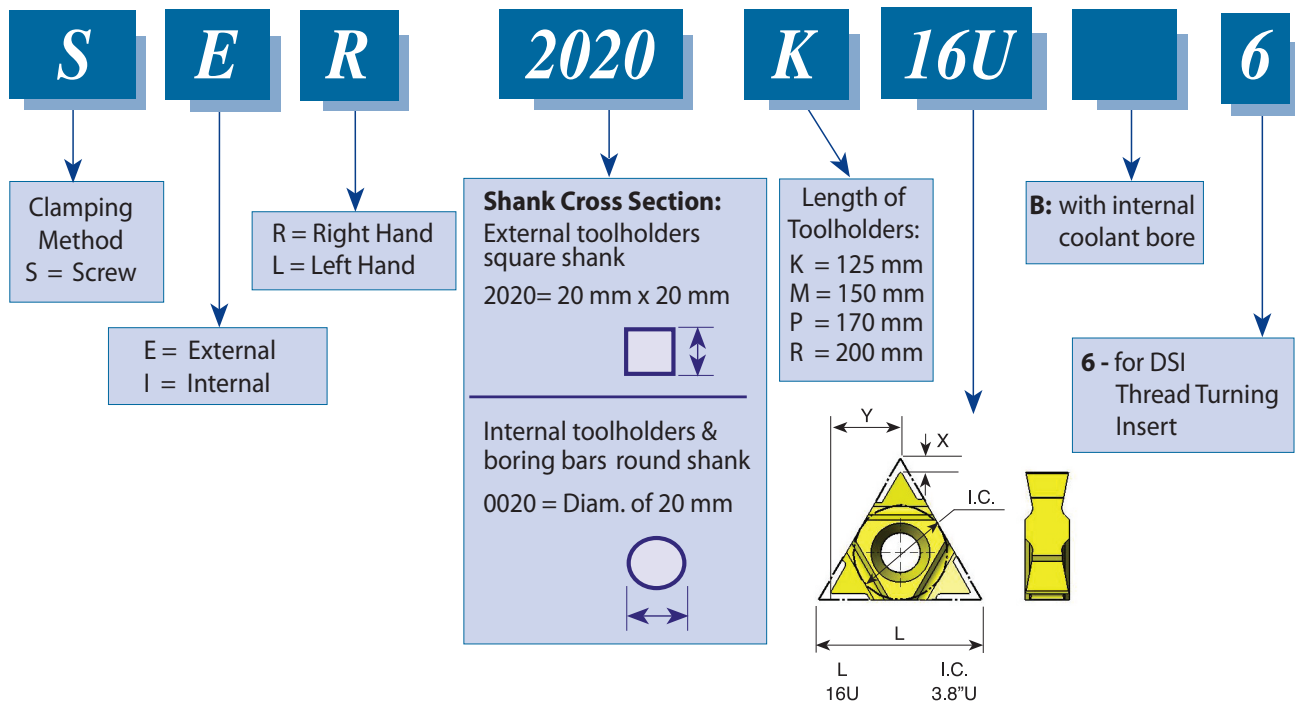
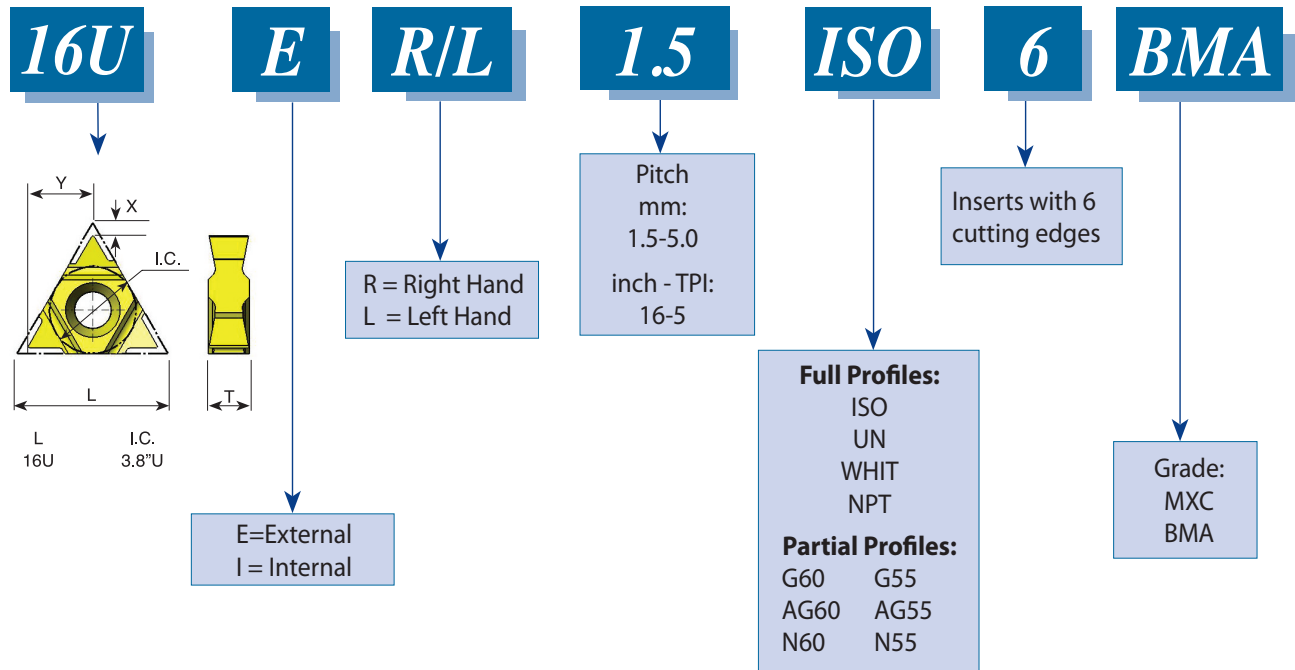

Partial Profile 60°

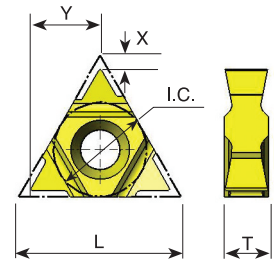

Pitch Range mm	Pitch Range TPI	L	I.C. in	EXTERNAL Ordering Code	INTERNAL Ordering Code	X	Y	T
1.75 - 3.0	14-8	16U	3/8U	16U ER/L G60-6	16U IR/L G60-6	1.4	7.1	4.5
0.5 - 3.0	48-8	16U	3/8U	16U ER/L AG60-6	16U IR/L AG60-6	1.4	7.1	4.5
3.5 - 5.0	7-5	16U	3/8U	16U ER/L N60-6	16U IR/L N60-6	1.2	7.3	4.5

Available grades: BMA or MXC
Order example: 16U ER/L G60-6 BMA

Partial Profile 55°

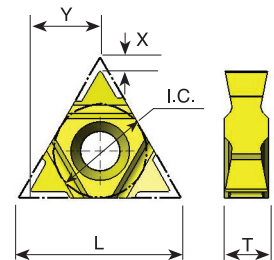

Pitch Range mm	Pitch Range TPI	L	I.C. in	EXTERNAL Ordering Code	INTERNAL Ordering Code	X	Y	T
1.75 - 3.0	14-8	16U	3/8U	16U ER/L G55-6	16U IR/L G55-6	1.4	7.1	4.5
0.5 - 3.0	48-8	16U	3/8U	16U ER/L AG55-6	16U IR/L AG55-6	1.4	7.1	4.5
3.5 - 5.0	7-5	16U	3/8U	16U ER/L N55-6	16U IR/L N55-6	1.2	7.3	4.5

Available grades: BMA or MXC

ISO

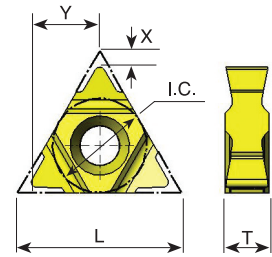

Pitch mm	L	I.C. in	EXTERNAL Ordering Code	INTERNAL Ordering Code	X	Y	T
1.5	16U	3/8U	16U ER/L 1.5 ISO-6	16U IR/L 1.5 ISO-6	1.6	6.9	4.5
1.75	16U	3/8U	16U ER/L 1.75 ISO-6	16U IR/L 1.75 ISO-6	1.6	6.9	4.5
2.0	16U	3/8U	16U ER/L 2.0 ISO-6	16U IR/L 2.0 ISO-6	1.6	6.9	4.5
2.5	16U	3/8U	16U ER/L 2.5 ISO-6	16U IR/L 2.5 ISO-6	1.6	6.9	4.5
3.0	16U	3/8U	16U ER/L 3.0 ISO-6	16U IR/L 3.0 ISO-6	1.6	6.9	4.5
3.5	16U	3/8U	16U ER/L 3.5 ISO-6	16U IR/L 3.5 ISO-6	1.6	6.9	4.5
4.0	16U	3/8U	16U ER/L 4.0 ISO-6	16U IR/L 4.0 ISO-6	1.6	6.9	4.5
4.5	16U	3/8U	16U ER/L 4.5 ISO-6	16U IR/L 4.5 ISO-6	1.6	6.9	4.5
5.0	16U	3/8U	16U ER/L 5.0 ISO-6	16U IR/L 5.0 ISO-6	1.6	6.9	4.5

Available grades: BMA or MXC

Order example: 16U ER/L 1.75 ISO-6 BMA

UN - Unified **UNC, UNF, UNEF, UNS**

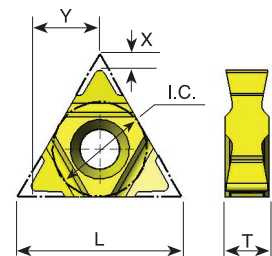

Pitch TPI	L	I.C. in	EXTERNAL Ordering Code	INTERNAL Ordering Code	X	Y	T
16	16U	3/8U	16U ER/L 16 UN-6	16U IR/L 16 UN-6	1.6	6.9	4.5
14	16U	3/8U	16U ER/L 14 UN-6	16U IR/L 14 UN-6	1.6	6.9	4.5
13	16U	3/8U	16U ER/L 13 UN-6	16U IR/L 13 UN-6	1.6	6.9	4.5
12	16U	3/8U	16U ER/L 12 UN-6	16U IR/L 12 UN-6	1.6	6.9	4.5
11.5	16U	3/8U	16U ER/L 11.5 UN-6	16U IR/L 11.5 UN-6	1.6	6.9	4.5
11	16U	3/8U	16U ER/L 11 UN-6	16U IR/L 11 UN-6	1.6	6.9	4.5
10	16U	3/8U	16U ER/L 10 UN-6	16U IR/L 10 UN-6	1.6	6.9	4.5
9	16U	3/8U	16U ER/L 9 UN-6	16U IR/L 9 UN-6	1.6	6.9	4.5
8	16U	3/8U	16U ER/L 8 UN-6	16U IR/L 8 UN-6	1.6	6.9	4.5
7	16U	3/8U	16U ER/L 7 UN-6	16U IR/L 7 UN-6	1.6	6.9	4.5
6	16U	3/8U	16U ER/L 6 UN-6	16U IR/L 6 UN-6	1.6	6.9	4.5
5	16U	3/8U	16U ER/L 5 UN-6	16U IR/L 5 UN-6	1.6	6.9	4.5

Available grades: BMA or MXC

For carbide grade and cutting speed see page A04-2 and 3

Whitworth 55° BSW, BSF, BSP, BSB

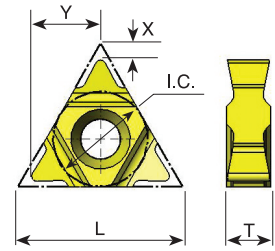

Pitch TPI	L	I.C. in	EXTERNAL Ordering Code	INTERNAL Ordering Code	X	Y	T
16	16U	3/8U	16U ER/L 16 W-6	16U IR/L 16 W-6	1.6	6.9	4.5
14	16U	3/8U	16U ER/L 14 W-6	16U IR/L 14 W-6	1.6	6.9	4.5
12	16U	3/8U	16U ER/L 12 W-6	16U IR/L 12 W-6	1.6	6.9	4.5
11	16U	3/8U	16U ER/L 11 W-6	16U IR/L 11 W-6	1.6	6.9	4.5
10	16U	3/8U	16U ER/L 10 W-6	16U IR/L 10 W-6	1.6	6.9	4.5
9	16U	3/8U	16U ER/L 9 W-6	16U IR/L 9 W-6	1.6	6.9	4.5
8	16U	3/8U	16U ER/L 8 W-6	16U IR/L 8 W-6	1.6	6.9	4.5
7	16U	3/8U	16U ER/L 7 W-6	16U IR/L 7 W-6	1.6	6.9	4.5
6	16U	3/8U	16U ER/L 6 W-6	16U IR/L 6 W-6	1.6	6.9	4.5
5	16U	3/8U	16U ER/L 5 W-6	16U IR/L 5 W-6	1.4	7.2	4.5

Available grades: BMA or MXC

Order example: 16U ER/L 9 W-6 BMA

NPT

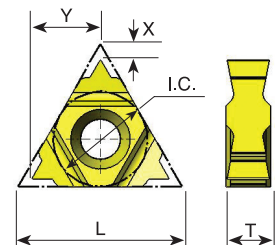

Pitch TPI	L	I.C. in	EXTERNAL Ordering Code	INTERNAL Ordering Code	X	Y	T
14	16U	3/8U	16U ER/L 14 NPT-6	16U IR/L 14 NPT-6	1.6	6.9	4.5
11.5	16U	3/8U	16U ER/L 11.5 NPT-6	16U IR/L 11.5 NPT-6	1.6	6.9	4.5
8	16U	3/8U	16U ER/L 8 NPT-6	16U IR/L 8 NPT-6	1.6	6.9	4.5

Available grades: BMA or MXC

Heavy Duty Thread Turning Toolholders

External

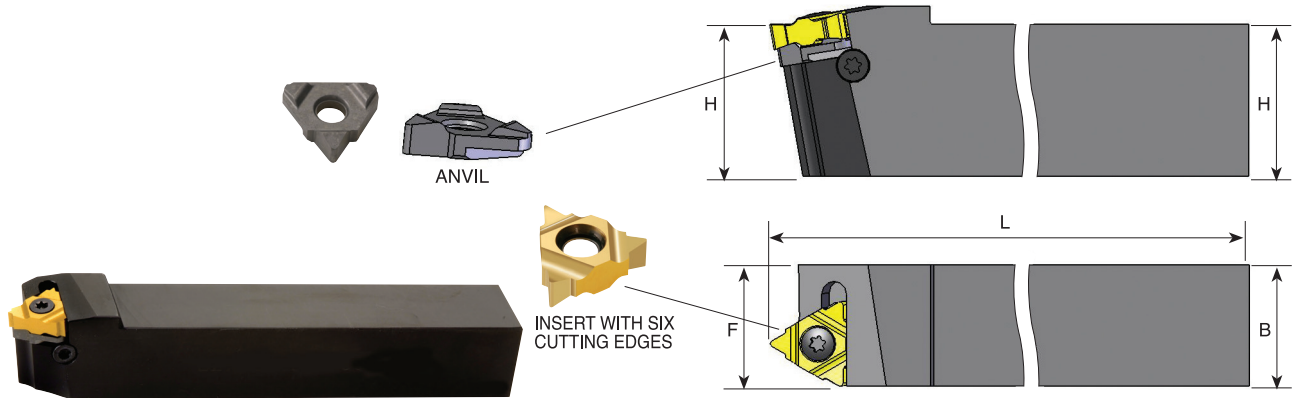

Ordering Code Right Hand	H	B	L	F	Insert Screw	Anvil Screw	Torx Key	RH Anvil	LH Anvil
SER 2020 K16U-6	20	20	125	20	S16	A16	K16	AER 16U-6	AEL 16U-6
SER 2520 M16U-6	25	20	150	20	S16	A16	K16	AER 16U-6	AEL 16U-6

For **LEFT HAND** toolholders specify SEL instead of SER

Internal with coolant bore

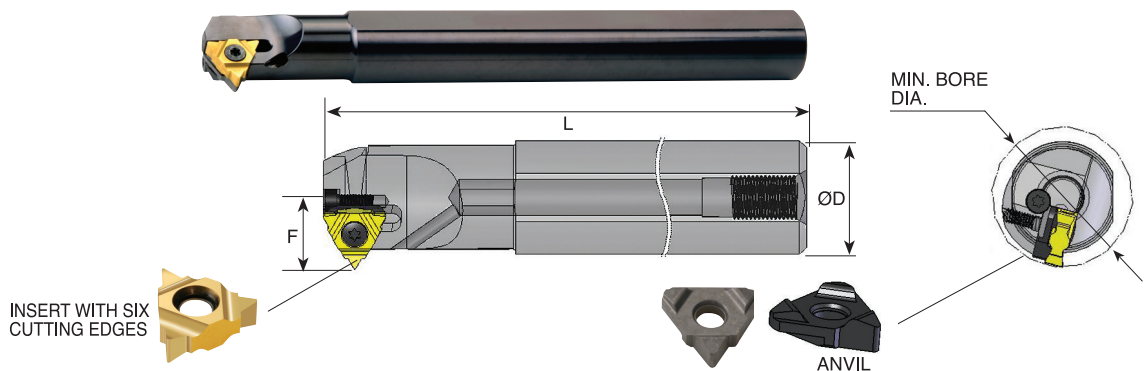

Ordering Code Right Hand	ØD	Min. bore dia.	L	F	Insert Screw	Anvil Screw	Torx Key	RH Anvil	LH Anvil
SIR 0020 P16UB-6	20	24	170	14.9	S16	A16	K16	AIR 16U-6	AIL 16U-6
SIR 0025 R16UB-6	25	29	200	17.4	S16	A16	K16	AIR 16U-6	AIL 16U-6

For **LEFT HAND** toolholders specify SIL instead of SIR



**Thread Turning
Catalog and CNC
Programming
Software**

Contents:	Page:	Contents:	Page:
Carbide Grade Selection	2	Thread Turning Methods	5
Type B inserts	2	Important Points about CPT Threading Inserts	6
Recommended cutting speed	3	Flank Clearance Angle	6
Conversion of Cutting Speed to Rotational Speed	4	Anvil Change Recommendation	7
Number of passes and depth of cut per pass for multitooth insert	4	Thread Turning - Step by Step	8-9
Number of threading passes selection for single point inserts	5	Troubleshooting	9
		Threading Inserts Standards	10

Carbide Grade Selection

Choose the CPT grade specifically formulated for your application from the following list:

Coated Grades

HBA
(H10-H25)
(S10-S25)

Extra-fine sub-micron grade with high toughness, for optimized performance on hardened steels and cast iron up to 62HRC, titanium alloys and super alloys (hastelloy, inconel and nickel based alloys).

BLU
(M10-M20)
(K05-K20)
(N10-N20)
(S10-S20)

PVD triple layer coated sub-micron grade for stainless steels, cast iron, titanium, non ferrous metals and most of the high temperature alloys.

BMA
(P20-P40)
(K20-K30)

PVD TiAlN coated sub-micrograin grade for stainless steels and exotic materials at medium to high cutting speeds.

P25C
(P15-P35)

PVD TiN coated grade for treated and hard alloy steels (25 HRc & up) at medium to low cutting speeds.

MXC
(K10-K20)
(P10-P25)

PVD TiN coated micrograin for free cutting untreated alloy steels (below 30 HRc), for stainless steels and cast iron.

BXC
(P30-P50)
(K25-K40)

PVD TiN coated grade for low cutting speed. Works well with wide range of stainless steels.

Uncoated Grades

P30*
(P20-P30)

Carbide grade for carbon and cast steels, works well at medium to low cutting speeds.

K20*
(K10-K30)

Carbide grade for non ferrous metals, aluminum and cast iron.

* Upon request

Note: Due to our unique and specialized production techniques, CPT coated inserts provide superior cutting performance and exceptionally long tool life.

Grade availability per inserts size

Grade	HBA	BLU	BMA	P25C	MXC	BXC	P30	K20
Insert sizes	11, 16, 22, 27	11, 16, 22	06, 08, 11, 16, 22, 27, 33U,	11, 16, 22, 27, 33U	11, 16, 22, 27, 33U	06, 08	11, 16, 22, 27, 33U	06, 08, 11, 16, 22, 27, 33U
		Type-B 11, 16	Type-B 11, 16					

Type B - Threading Inserts

A combination of ground profile, and sintered chip-breaker threading inserts. Unlike most other manufacturers inserts, this combination ensures a consistent high quality thread, with precise shape and dimensions. Two different unique styles of chip-breaker were designed to suit the different specific requirements of Internal threads and External threads. All of CPT Type B inserts are made of BMA Sub-Micrograin grade.

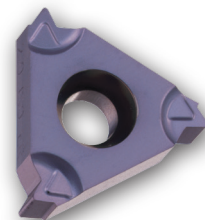

Recommended cutting speed (m/min) for thread turning inserts

ISO Standard	Material		Condition							
				HBA	BLU	BMA	P25C	MXC	BXC	K20
P	Non-Alloy Steel and Cast Steel, Free Cutting Steel	<0.25%C	Annealed	110-210	120-180	100-180	100-180	70-150	50-130	
		≥0.25%C	Annealed							
		<0.55%C	Quenched & Tempered							
		≥0.55%C	Annealed							
			Quenched & Tempered							
	Low Alloy Steel and Cast Steel (less than 5% alloying elements)	Annealed	90-140	80-130	70-120	70-120	60-90	50-80		
High Alloy Steel, Cast Steel, and Tool Steel	Annealed	70-90	60-80	50-60	55-70	50-60	40-50			
	Quenched & Tempered									
M	Stainless Steel and Cast Steel	Ferritic / Martensitic	110-160	90-130	60-90	60-90	50-80	50-80		
		Martensitic								
		Austenitic								
K	Cast Iron Nodular (GGG)	Ferritic / Pearlitic	120-150	100-130		80-110	60-90			
		Pearlitic								
	Grey Cast Iron (GG)	Ferritic	140-150	120-130		90-100	65-85			
		Pearlitic								
Malleable Cast Iron	Ferritic	110-140	100-130		80-100	60-85				
	Pearlitic									
N	Aluminum-Wrought Alloy		Not Cureable	250-500			200-400	150-400	200-400	100-400
			Cured							
	Aluminum-Cast, Alloyed	≤12% Si	Not Cureable	280-500			200-500	150-350	200-500	110-300
			Cured							
		>12% Si	High Temperature							
	Copper Alloys	>1% Pb	Free Cutting	190-350			150-250	110-180	150-250	90-150
Brass										
		Electrolytic Copper								
Non Metallic		Duroplastics, Fiber Plastics				200-300	150-210	100-200	110-150	
		Hard Rubber								
S	High Temp. Alloys, Super Alloys	Fe based	Annealed	20-80	30-65	25-60				
			Cured							
		Ni or Co based	Annealed							
			Cured							
	Titanium Alloys		Alpha +Beta Alloys Cured	30-60	40-50	35-45			35-45	
H	Hardened Steel		Hardened 45-50 HRc	30-60	40-50	35-45				
			Hardened 51-55 HRc							
			Hardened 56-62 HRc							
	Chilled Cast Iron		Cast	20-50	30-40	25-35				
Cast Iron		Hardened	20-40	20-30	15-25					

Conversion of Cutting Speed to Rotational Speed

Conversion of a selected cutting speed to rotational speed is calculated by the following formula:

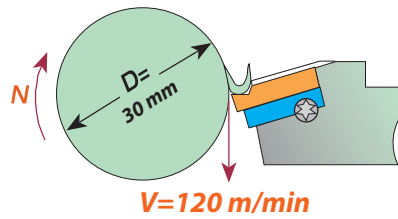

Example

$$N = \frac{V \times 1000}{\pi \times D} = \frac{120 \times 1000}{3.14 \times 30} = 1274 \text{ RPM}$$

Number of passes and depth of cut per pass for multitooth insert

	Pitch mm	Insert Size		No. of Teeth	Ordering Code	No. of Passes	Depth of Cut per pass			
		L	I.C. (in)				1	2	3	4
ISO External	1.00	16	3/8	3	16 ER 1.0 ISO 3M	2	0.38	0.25		
	1.50	16	3/8	2	16 ER 1.5 ISO 2M	3	0.42	0.30	0.20	
	1.50	22	1/2	3	22 ER 1.5 ISO 3M	2	0.55	0.37		
	2.00	22	1/2	2	22 ER 2.0 ISO 2M	3	0.57	0.40	0.28	
	2.00	22	1/2	3	22 ER 2.0 ISO 3M	2	0.76	0.49		
ISO Internal	3.00	27	5/8	2	27 ER 3.0 ISO 2M	4	0.59	0.51	0.42	0.32
	1.00	16	3/8	3	16 IR 1.0 ISO 3M	2	0.33	0.25		
	1.50	16	3/8	2	16 IR 1.5 ISO 2M	3	0.38	0.29	0.20	
	1.50	22	1/2	3	22 IR 1.5 ISO 3M	2	0.50	0.37		
	2.00	22	1/2	2	22 IR 2.0 ISO 2M	3	0.52	0.37	0.26	
UN External	2.00	22	1/2	3	22 IR 2.0 ISO 3M	2	0.70	0.45		
	3.00	27	5/8	2	27 IR 3.0 ISO 2M	4	0.58	0.46	0.39	0.30
	16	16	3/8	2	16 ER 16 UN 2M	3	0.44	0.31	0.22	
	16	22	1/2	3	22 ER 16 UN 3M	2	0.58	0.39		
	12	22	1/2	2	22 ER 12 UN 2M	3	0.59	0.42	0.30	
UN Internal	12	22	1/2	3	22 ER 12 UN 3M	2	0.78	0.52		
	8	27	5/8	2	27 ER 8 UN 2M	4	0.62	0.54	0.45	0.35
	16	16	3/8	2	16 IR 16 UN 2M	3	0.42	0.28	0.22	
	16	22	1/2	3	22 IR 16 UN 3M	2	0.55	0.37		
	12	22	1/2	2	22 IR 12 UN 2M	3	0.53	0.38	0.31	
Whitworth 55° External	12	22	1/2	3	22 IR 12 UN 3M	2	0.74	0.48		
	8	27	5/8	2	27 IR 8 UN 2M	4	0.63	0.50	0.40	0.30
	14	16	3/8	2	16 ER 14 W 2M	3	0.52	0.37	0.27	
	14	22	1/2	3	22 ER 14 W 3M	2	0.70	0.46		
	11	22	1/2	2	22 ER 11 W 2M	3	0.67	0.47	0.34	
Whitworth 55° Internal	14	16	3/8	2	16 IR 14 W 2M	3	0.52	0.37	0.27	
	14	22	1/2	3	22 IR 14 W 3M	2	0.70	0.46		
	11	22	1/2	2	22 IR 11 W 2M	2	0.67	0.47	0.34	
NPT External	14	16	3/8	2	16 ER 14 NPT 2M	3				
	11.5	22	1/2	2	22 ER 11.5 NPT 2M	4	0.54	0.47	0.37	0.30
	11.5	27	5/8	3	27 ER 11.5 NPT 3M	4	0.76	0.54	0.38	
NPT Internal	8	27	5/8	2	27 ER 8 NPT 2M	4	0.81	0.60	0.55	0.45
	14	16	3/8	2	16 IR 14 NPT 2M	3				
	11.5	22	1/2	2	22 IR 11.5 NPT 2M	4	0.54	0.47	0.37	0.30
	11.5	27	5/8	3	27 IR 11.5 NPT 3M	4	0.76	0.54	0.38	
API Round External	8	27	5/8	2	27 IR 8 NPT 2M	4	0.81	0.60	0.55	0.45
	10	22	1/2	2	22 ER 10 APIRD 2M	3	0.60	0.50	0.31	
	10	27	5/8	3	27 ER 10 APIRD 3M	2	1.00	0.41		
API Round Internal	8	27	5/8	2	27 ER 8 APIRD 2M	3	0.80	0.60	0.41	
	10	22	1/2	2	22 IR 10 APIRD 2M	3	0.60	0.50	0.31	
	10	27	5/8	3	27 IR 10 APIRD 3M	2	1.00	0.41		
	8	27	5/8	2	27 IR 8 APIRD 2M	3	0.80	0.60	0.41	

Number of threading passes selection for single point inserts

Pitch:	mm TPI	0.5 48	0.8 32	1.0 24	1.25 20	1.5 16	1.75 14	2.0 12	2.5 10	3.0 8	4.0 6	6.0 4
Number of Passes		3-6	4-7	4-9	6-10	5-11	9-12	6-13	7-15	8-17	10-20	11-22

NOTES:

1. For most standard applications the middle of the range is a good starting point.
2. For most materials, the tougher the material, the higher the number of cutting passes you should select.
3. As a general rule of thumb, fewer passes are better than more speed.

Thread Turning Methods

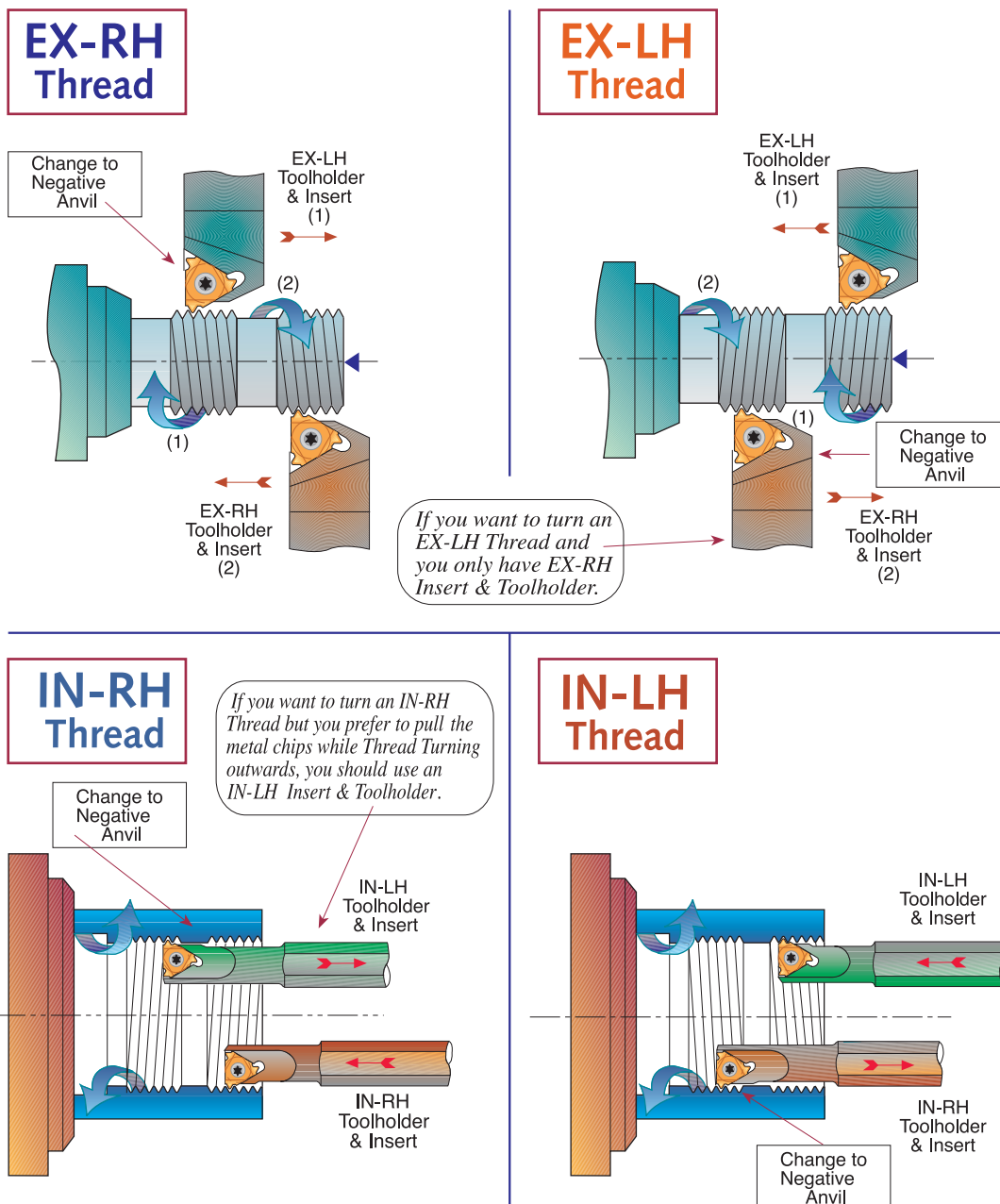

Important Points about CPT Threading Inserts

1. In most thread forms internal and external threads have different depth and radii, thus tools are not interchangeable

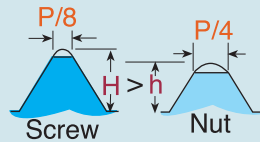

2. The Insert relief angle of a standard CPT external toolholder is 10°; for an internal toolholder it is 15°. This 5° difference is to provide additional necessary radial clearance.

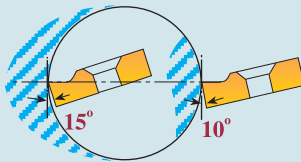

3. Our built-in relief angles ensure automatic insert flank angle clearance.

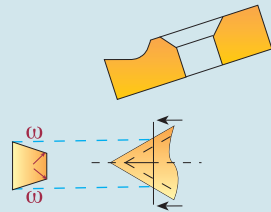

4. Profiles of CPT internal & external threading inserts are precision ground to ensure accurate thread geometry when used in their corresponding toolholders. Using internal inserts with an external holder will result in distortion of angle and insert geometry.

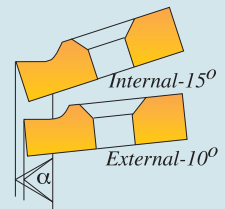

5. Insert and toolholder should always match. An IN-RH insert must be used with an IN-RH toolholder. No mismatch is allowed.



Flank Clearance Angle ω

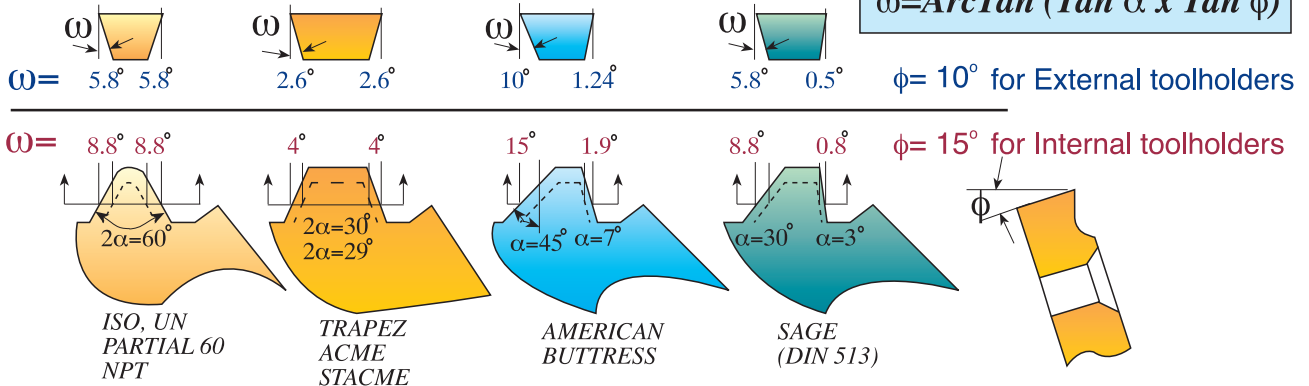

Anvil Change Recommendation

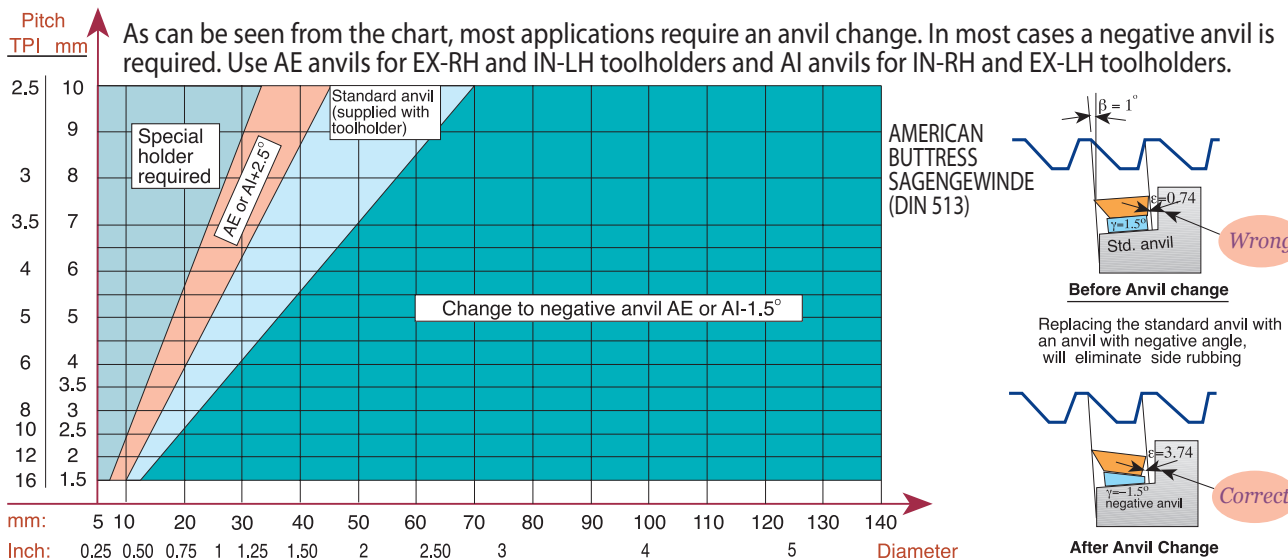
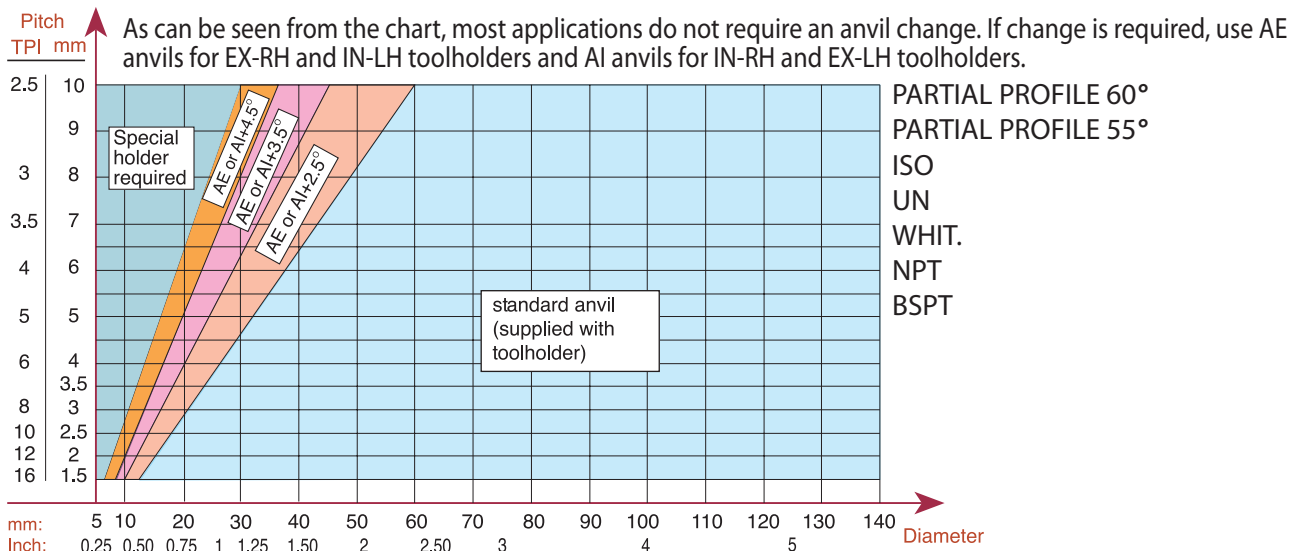
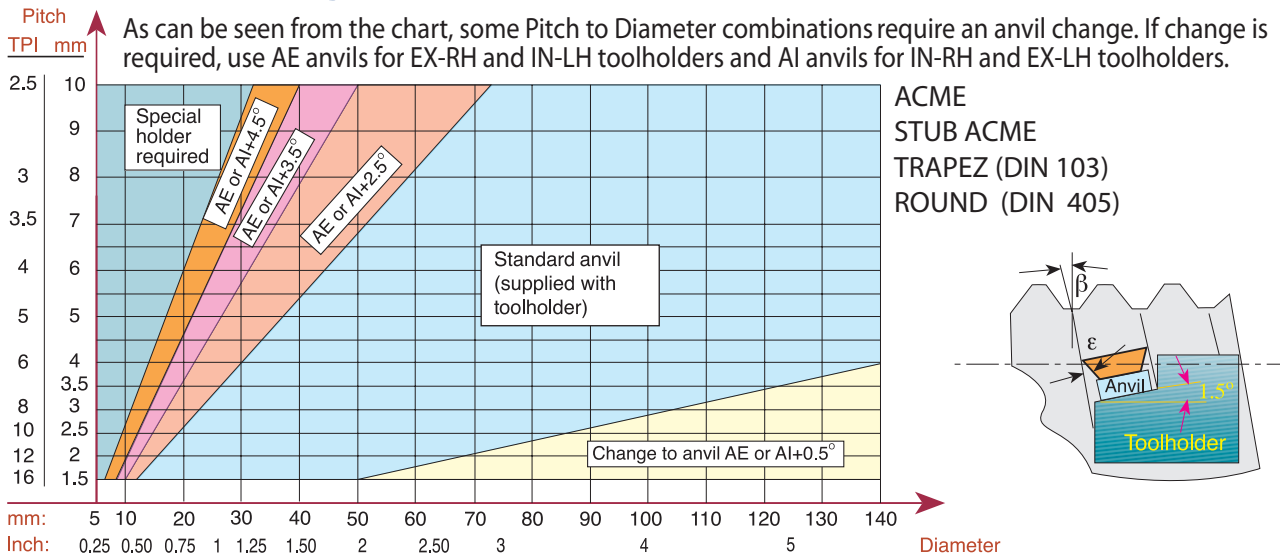

Thread Turning - Step by Step

Step 1 : Choose Thread Turning Method from page A04-5

Step 2 : Choose Insert

Step 3 : Choose Toolholder

Step 4 : Choose Insert Grade

Step 5 : Choose Thread Turning Speed

Step 6 : Choose Number of Threading Passes

In most cases the above mentioned 6 steps would be the steps needed to ensure a good thread. When cutting more complicated threads such as TRAPEZ, ACME, BUTTRESS or SAGE, it is advisable to check the effect of the thread "HELIX ANGLE" β on the "RESULTANT FLANK CLEARANCE" ϵ . If ϵ is smaller than 2° , an anvil change is required.

Step 7 : Find Thread Helix Angle

Step 8 : Choose Correct Anvil

EXAMPLES:

Example No. 1:

Step 1: Choose Thread Turning Method from page A04-5, we chose **EX - RH Insert & Toolholder**

Step 2: Choose Insert from page A01-7: **16 ER 1.5 ISO**

Step 3: Choose Toolholder from page A02-3: **SER 2020 K16**

Step 4: Choose Insert Grade from selection on page A04-2
Our choice for Alloy Steel is Grade **P25C**

Step 5: Choose Thread Turning Speed from chart on page A04-3, we chose **100 m/min**

Rotational Speed calculation:
$$N = \frac{100 \times 1000}{\pi \times 30} = 1065 \text{ rpm}$$

Step 6: Choose Number of Threading passes from table on page A04-5, we chose **8 passes**

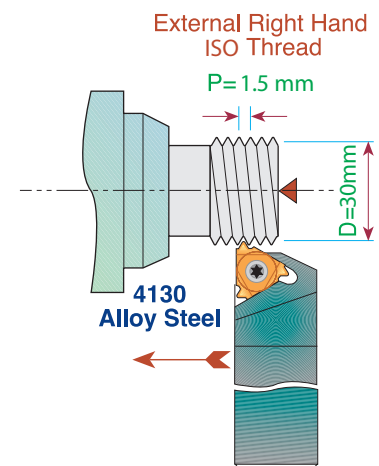

Example No. 2:

Step 1: Choose Thread Turning Method from page A04-5
Usually, an IN-RH Toolholder and Insert will be chosen, however, in this particular case we prefer to pull the metal chips while thread turning outward, thus we chose to work with **IN-LH Insert & Toolholder**

Step 2: Choose Insert from page A01-11: **16 IL 12 UN**

Step 3: Choose Toolholder from page A02-8: **SIL 0025 R16**
Note: since we thread cut IN-RH thread outward with an IN-LH tool, do not forget to replace the standard anvil (supplied with the holder) with a negative anvil **AE16-1.5**

Step 4: Choose Insert Grade from selection on page A04-2
Our choice for Brass is Grade **K20**

Step 5: Choose Thread Turning Speed from chart on page A04-3, we chose **150 m/min**

Rotational Speed calculation:
$$N = \frac{150 \times 1000}{\pi \times 38.1} = 1254 \text{ RPM}$$

Step 6: Choose Number of Threading passes from table on page A04-5, we chose **9 passes**

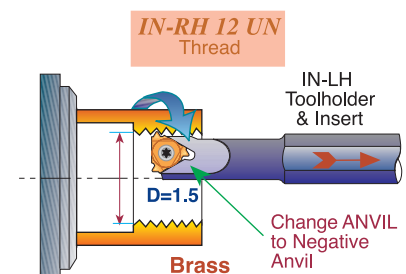

Example No. 3:

- Step 1: Choose Thread Turning Method from page A04-5
We chose EX-RH Insert & Toolholder.
- Step 2: Choose Insert from page A01-31: **16 ER 12 ABUT**
- Step 3: Choose Toolholder from page A02-3: **SER 2525 M16**
- Step 4: Choose Insert Grade from selection on page A04-2
Our choice for Stainless Steel is Grade **BMA**
- Step 5: Choose Thread Turning Speed from chart on page A04-3
We chose 120 m/min.
Rotational Speed calculation:
$$N = \frac{120 \times 1000}{\pi \times 40} = 954 \text{ RPM}$$
- Step 6: Choose Number of Threading passes from table on page A04-5. We chose **13 passes**
- Step 7: Find Thread Helix Angle: on page A02-19 for Pitch of 12 TPI and 40 Diameter Helix Angle as shown in the chart is 1°
- Step 8: Choose correct Anvil: As can be seen from the chart on page A04-7, for AMERICAN BUTTRESS Thread, for 12 TPI and 40 Diameter a negative anvil **AE16-1.5** should replace the standard anvil supplied with the toolholder

EX-RH, AMERICAN BUTTRESS
12 TPI on 40 mm diameter.

Stainless Steel 304

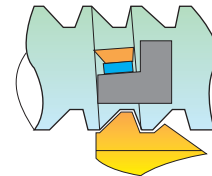

Replacing the standard anvil with an anvil with negative angle will eliminate side rubbing

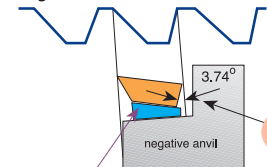

Anvil chosen:
AE16-1.5

Troubleshooting

Chipping



1. Use a tougher carbide grade
2. Eliminate tool overhang
3. Check if insert is correctly clamped
4. Eliminate vibration

Crater Wear



1. Reduce cutting speed
2. Apply coolant fluid
3. Use a harder carbide grade

Build-up Edge



1. Increase cutting speed
2. Use a tougher carbide grade

Thermal Cracking



1. Reduce cutting speed
2. Apply coolant fluid
3. Use a tougher carbide grade

Deformation

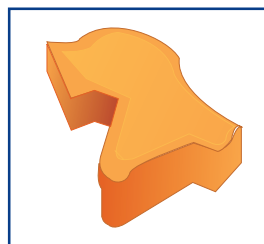

1. Use a harder carbide grade
2. Reduce cutting speed
3. Reduce depth of cut
4. Apply coolant fluid

Fracture



1. Use a tougher carbide grade
2. Reduce depth of cut
3. Index insert sooner
4. Check machine and tool stability

Threading Inserts Standards

Thread Profile	Standard	Thread Class
ISO	DIN 13	6g / 6H
UN	ANSI B1.1-1989	2A / 2B
WHITWORTH	B.S. 84: 1956	Medium Class
NPT	ANSI B1.20.1-1983	-
NPTF	ANSI B1.20.3-1976	-
NPS	ANSI B1.20.1-1983	-
NPSM	ANSI B1.20.1-1983	-
BSPT	B.S. 21: 1957	-
DIN 477	DIN 477	-
ACME	ANSI B1.5-1988	3G (EXT), 3G / 2G (INT)
STUB ACME	ANSI B1.5-1988	2G
TRAPEZ	DIN 103	7e / 7H
ROUND	DIN 405	Class 7
UNJ	MIL-S-8879C	3A / 3B
MJ	ISO 5855	4h/6h, 4H/5H
AMERICAN BUTTRESS	ANSI B1.9-1973	Class 2
SAGENGEWINDE	DIN 513	-
PG	DIN 40430	-
V-0.040	API Spec7	-
V-0.038R	API Spec7	-
V-0.050	API Spec7	-
V-0.055	API Spec7	-
API ROUND	API Spec Standard 5B	-
EXTREME – LINE CASING	API Spec Standard 5B	-
BUTTRESS CASING	API Spec Standard 5B	-
VAM	VAM	-
HUGHES	HUGHES	-
PAC	PAC	-

DIN: **Deutsches Institut für Normung**
 ANSI: **American National Standards Institute**
 API: **American Petroleum Institute**
 B.S.: **British Standards**
 ISO: **International Organisation for Standardization**
 MIL-S: **Military Specification**
 NPT: **American National Standard Taper Pipe Thread**
 NPTF: **National Standard Taper Fuel:Dryseal USA**
 PAC: **Pacific Asia Connection**
 NPS: **Straight thread,same as NPT without taper**
 NPSM: **Free-Fitting Mechanical Joints**