

PRODUCT OF THE MONTH APRIL

BUY 10 MINI INSERTS
AND GET
50 % Discount

OFF A
MATCHING HOLDER

Promotional code: **PDM26-04**



Product of the Month for April: Mini Tools

Vertical turning plates & tool holders for precise threading, grooving, drilling, profiling, and chamfering.

Benefits:

Solid carbide for high vibration resistance, Ideal for long overhangs, Through-hole for coolant, Quick tool change

Applications:

Perfect for long threads and large pitches – even with large overhangs.

Quality:

Fine-grain carbide with PVD coating for high temperature resistance and wear resistance—suitable for use in all common materials.

Please specify in your order the article numbers of the chosen Mini Tools, the holder and the promotional code: PDM26-04.

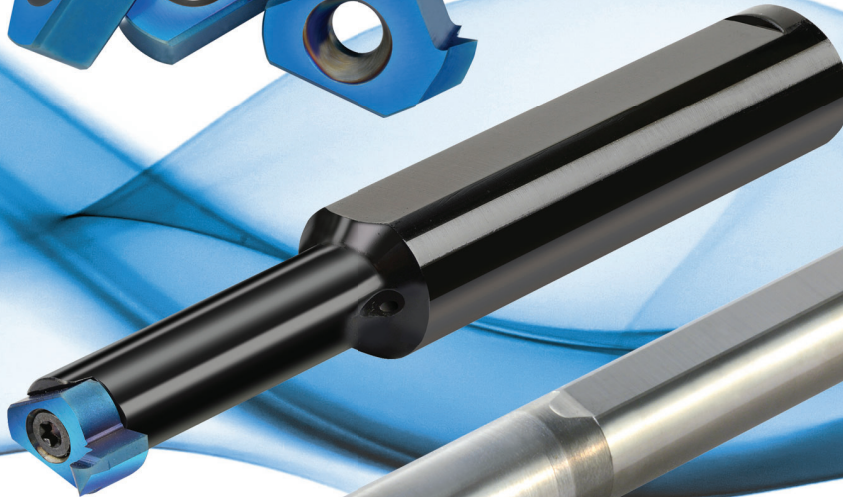

Demonstration

Vertical Inserts and Toolholders for threading, chamfering, grooving and turning

Advantages

Carbide grade:

BLU-Sub-Micron grade with advanced PVD triple layer coating delivering high heat resistance and smooth cutting operation.

- Carbide shank toolholder provides excellent vibration resistance.
- Long reach.
- Through coolant.
- For threading, grooving, boring and chamfering.
- Quick indexing.

Typical Applications:

- Long threads or applications requiring over-hang.
- Enables production of threads with large pitch/profile.
- Threading, grooving, boring, profiling and chamfering - It's possible to offer most of the Tiny Tools profiles on the insert.

Contents:

Page:

Contents:

Page:

Product Identification	2
Partial Profile 60°	3
Partial Profile 55°	3
Full Profile - ISO	4
Full Profile - UN	4
Acme	5
Trapez - DIN 103	5
Chamfering	6
Grooving	7
Grooving, Circlip Ring Grooves DIN 471/472	8

Full Radius Grooving	8
Back Turning	9
Boring and Profiling	9
Boring, Profiling and Facing	10
Face grooving	11
Face grooving, Full radius	12
Carbide Shank Toolholders	13
Steel Toolholders	14
Technical Section	14

Product Identification - Ordering Codes

Inserts

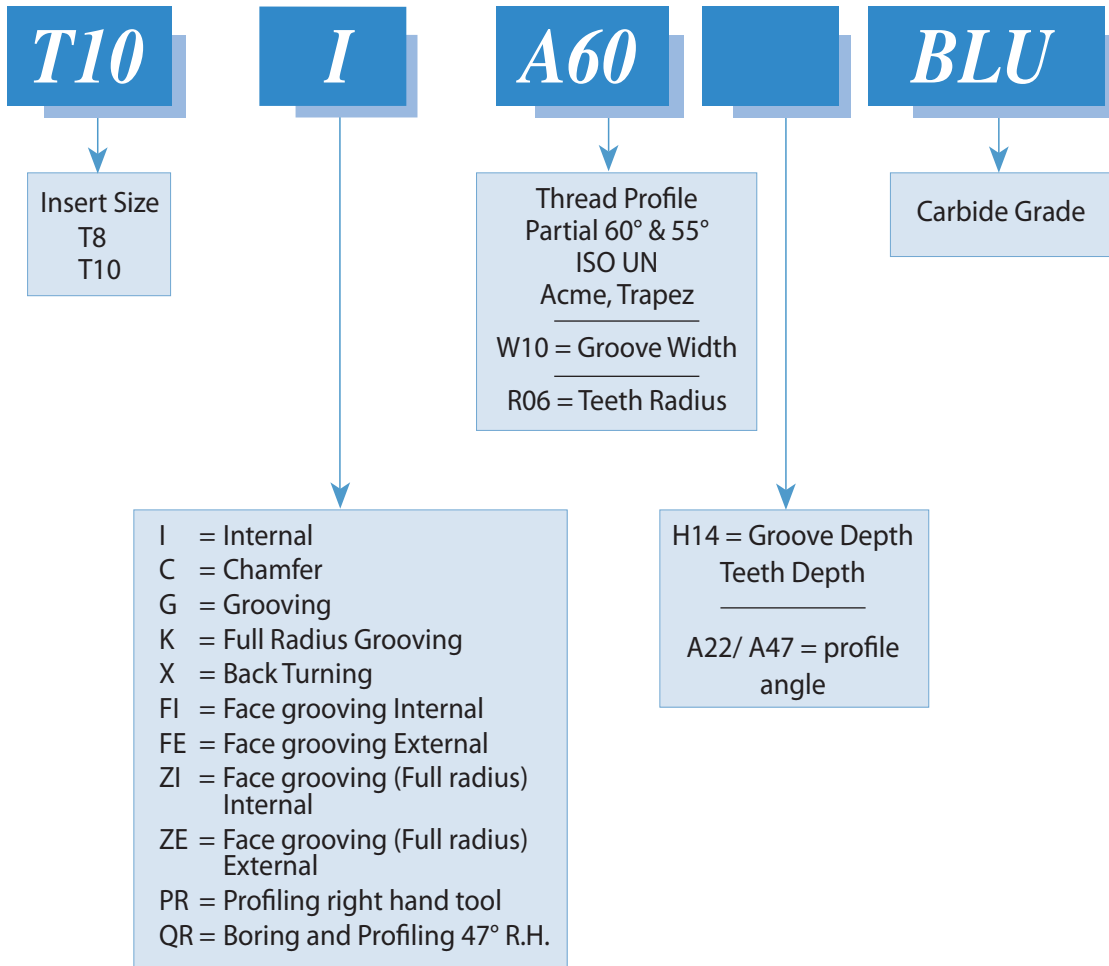

Toolholders

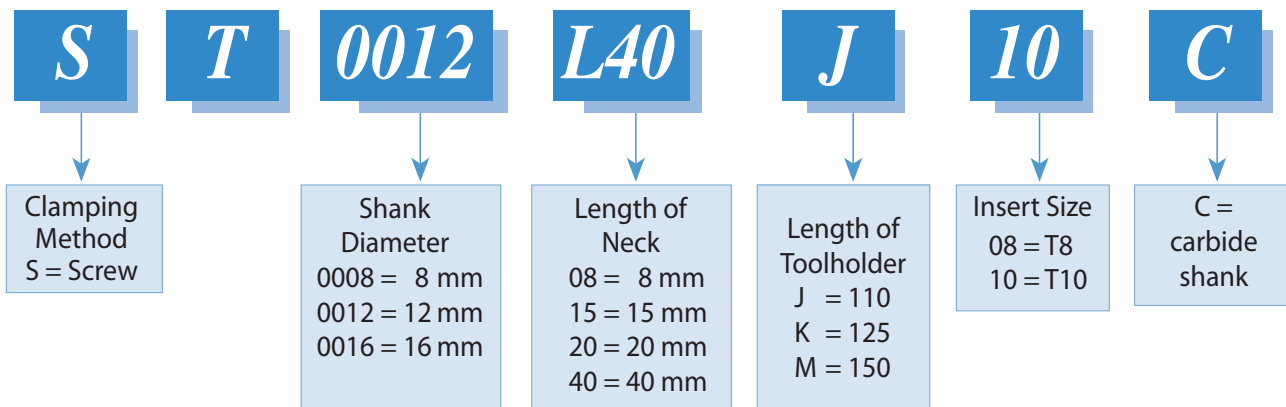

Partial Profile 60°

Same insert for internal and external thread

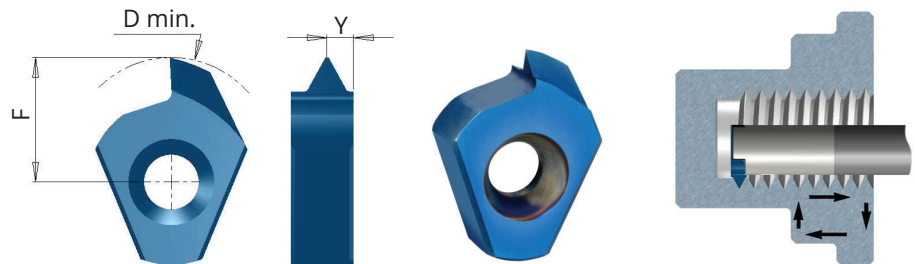

Insert Type	Ordering Code	Pitch Range mm	Pitch Range TPI	D min	F	Y
T8	T8 A60	Int 0.5-0.75 Ex 0.4- 0.75	56-32 64-32	8.0	3.7	0.6
	T8 G60	Int 1.0-1.25 Ex 0.8- 1.0	28-20 32-28	8.4	4.1	0.8
T10	T10 A60	Int 0.5-0.8 Ex 0.4-0.8	56-28 64-32	11.6	6.4	0.6
	T10 G60	Int 1.0-2.0 Ex 0.8-1.75	28-13 32-15	12.3	7.1	1.3
	T10 D60	Int 2.0-3.0 Ex 1.75-2.5	13-8 15-10	13.1	7.9	1.5

Order example: T8 G60 BLU

Partial Profile 55°

Same insert for internal and external thread

Insert Type	Ordering Code	Pitch Range mm	Pitch Range TPI	D min	F	Y
T8	T8 G55	1.25-1.5	19-18	9.1	4.8	1.0
	T8 U55	1.75-2.0	16-14	8.7	4.4	1.2
T10	T10 G55	1.25-2.0	19-14	12.4	7.2	1.2

Full Profile

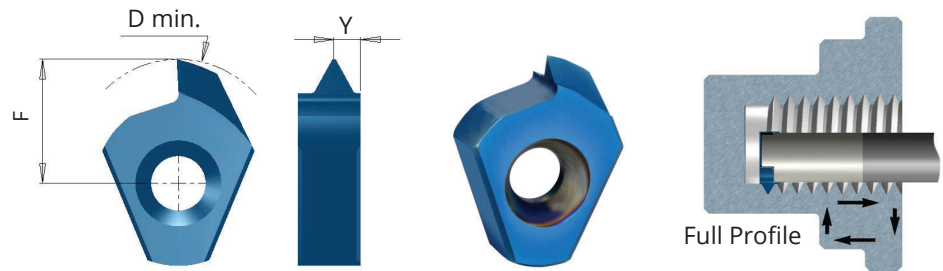

ISO

Inserts for internal thread

Insert Type	Ordering Code	Pitch mm	M coarse	M fine	D min	F	Y
T8	T8 I 0.5 ISO	0.5		M8.5	8.0	3.6	0.5
	T8 I 0.75 ISO	0.75		M9	8.1	3.8	0.6
	T8 I 1.0 ISO	1.0		M9	8.0	3.7	0.7
	T8 I 1.25 ISO	1.25		M10	8.2	3.9	0.8
	T8 I 1.5 ISO	1.5	M10	M12	8.4	4.1	1.0
	T8 I 1.75 ISO	1.75	M12	-	8.6	4.3	1.1
	T8 I 2.0 ISO	2.0	M14	M17	8.8	4.5	1.3
T10	T10 I 0.5 ISO	0.5		M12	11.3	6.1	0.5
	T10 I 0.75 ISO	0.75		M12	11.3	6.1	0.6
	T10 I 1.0 ISO	1.0		M13	11.7	6.5	0.7
	T10 I 1.5 ISO	1.5		M14	11.7	6.5	1.0
	T10 I 2.0 ISO	2.0	M16	M17	12.0	6.8	1.3
	T10 I 2.5 ISO	2.5	M18, M20	-	12.6	7.4	1.4
	T10 I 3.0 ISO	3.0	M24	M28	12.6	7.4	1.6

Order example: T10 I 0.5 ISO BLU

UN

Inserts for internal thread

Insert Type	Ordering Code	Pitch TPI	Nominal size	UNC	UNF	UNEF	D min	F	Y
T8	T8 I 32UN	32	7/16, 1/2			3/8	8.3	4.0	0.6
	T8 I 28UN	28	3/8			7/16, 1/2	8.3	4.0	0.7
	T8 I 24UN	24			3/8		8.3	4.0	0.7
	T8 I 20UN	20	3/8		7/16, 1/2		8.2	3.9	0.9
	T8 I 16UN	16	7/16, 1/2				8.7	4.4	1.0
	T8 I 14UN	14		7/16			8.8	4.5	1.2
	T8 I 13UN	13		1/2			8.8	4.5	1.3
T10	T10 I 20UN	20	9/16, 5/8, 11/16			3/4	12.0	6.8	0.9
	T10 I 18UN	18			9/16, 5/8		12.0	6.8	1.0
	T10 I 16UN	16	9/16, 5/8, 11/16		3/4		12.0	6.8	1.1
	T10 I 14UN	14			7/8		12.1	6.9	1.2
	T10 I 12UN	12	5/8, 11/16, 3/4	9/16			12.1	6.9	1.4
	T10 I 11UN	11		5/8			12.5	7.3	1.5
	T10 I 10UN	10		3/4			12.6	7.4	1.5

Acme

Inserts for internal thread

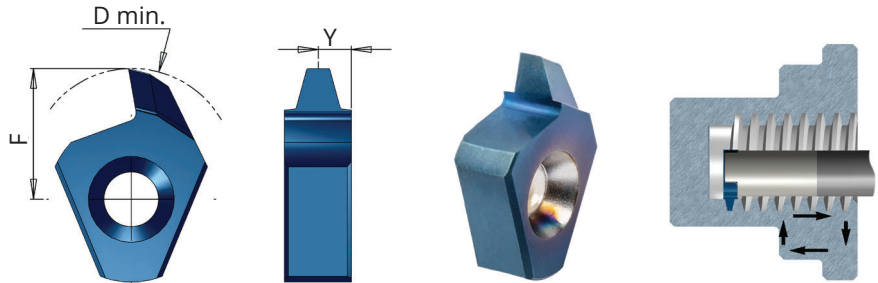

Insert Type	Ordering Code	Pitch TPI	Thread size	D min	F	Y
T8	T8 I 10 ACME	10	1/2-10	10.1	5.5	1.3
T10	T10 I 8 ACME	8	5/8-8	12.7	7.3	1.6
	T10 I 6 ACME	6	3/4-6	14.8	7.9	2.0

Order example: T10 I 6 ACME BLU

Trapez - DIN103

Inserts for internal thread

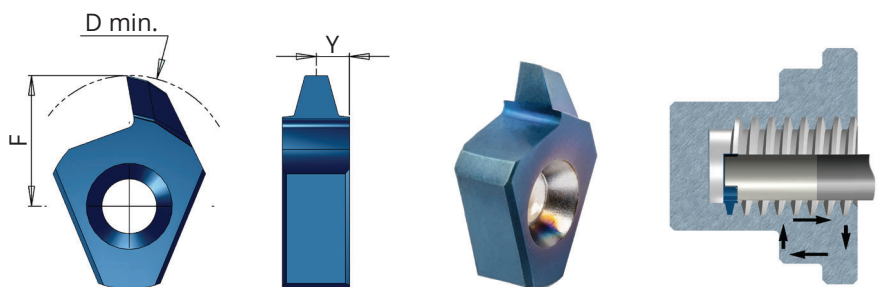

Insert Type	Ordering Code	Pitch mm	Thread size	D min	F	Y
T8	T8 I 2 TR	2	Tr12x2, Tr14x2	10.0	4.8	1.0
	T8 I 3 TR	3	Tr14x3	11.0	5.8	1.5
T10	T10 I 2 TR	2	Tr16x2, Tr18x2, Tr20x2	14.0	7.0	1.0
	T10 I 3 TR	3	Tr22x3	19.0	7.9	1.5
	*T10 I 4 TR	4	Tr16x4, Tr18x4	12.0	6.7	2.0

*To use with T10 toolholders version B

Chamfering

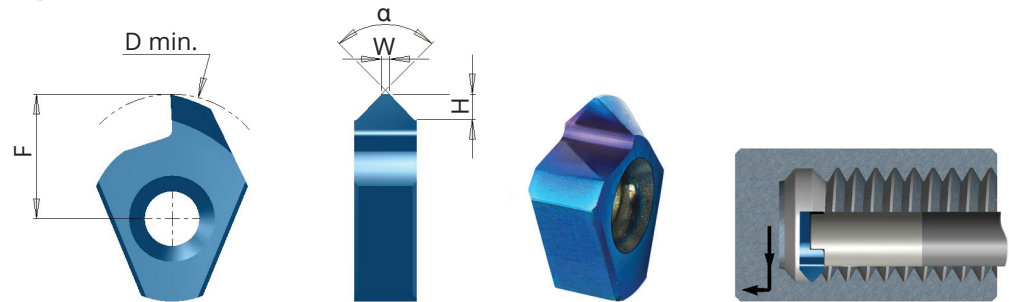

Insert Type	Ordering Code	W	H max	α	D min	F
T8	T8 C90	0.2	1.4	90°	8.8	4.5
T10	T10 C90	0.2	1.8	90°	12.7	7.5

Same insert for right and left hand chamfers

Order example: T8 C90 BLU

Grooving

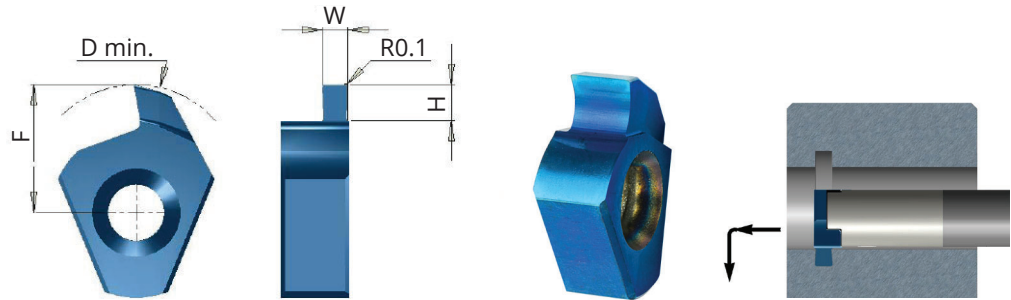

Insert Type	Ordering Code	W		R	H max	D min	F
		mm	inch				
T8	T8 G W08 H20	0.79	.031	0.1	2.0	9.4	5.1
	T8 G W10 H20	1.0	.039	0.1	2.0	9.4	5.1
	T8 G W12 H20	1.19	.047	0.1	2.0	9.4	5.1
	T8 G W15 H20	1.5	.059	0.1	2.0	9.4	5.1
	T8 G W16 H20	1.59	.063	0.1	2.0	9.4	5.1
	T8 G W20 H20	2.0	.079	0.1	2.0	9.4	5.1
	T8 G W24 H20	2.38	.094	0.1	2.0	9.4	5.1
	T8 G W25 H20	2.5	.098	0.1	2.0	9.4	5.1
T8 G W30 H20	3.0	.118	0.1	2.0	9.4	5.1	
T10	T10 G W08 H28	0.79	.031	0.1	2.8	13.4	7.9
	T10 G W10 H14	1.0	.039	0.1	1.4	12.3	7.1
	T10 G W10 H23	1.0	.039	0.1	2.3	13.1	7.9
	T10 G W12 H28	1.19	.047	0.1	2.8	13.4	7.9
	T10 G W15 H14	1.5	.059	0.1	1.4	12.3	7.1
	T10 G W15 H23	1.5	.059	0.1	2.3	13.1	7.9
	*T10 G W15 H40	1.5	.059	0.1	4.0	13.5	7.9
	T10 G W16 H28	1.59	.063	0.1	2.8	13.4	7.9
	T10 G W20 H14	2.0	.079	0.1	1.4	12.3	7.1
	T10 G W20 H23	2.0	.079	0.1	2.3	13.1	7.9
	*T10 G W20 H40	2.0	.079	0.1	4.0	13.5	7.9
	T10 G W24 H28	2.38	.094	0.1	2.8	13.4	7.9
	T10 G W25 H23	2.5	.098	0.1	2.3	13.1	7.9
	*T10 G W25 H40	2.5	.098	0.1	4.0	13.5	7.9
	T10 G W30 H23	3.0	.118	0.1	2.3	13.1	7.9
*T10 G W30 H40	3.0	.118	0.1	4.0	13.5	7.9	

*To use with T10 toolholders version B

Tolerance: $W \pm 0.02 \text{ mm} / .001''$

Order example: T10 G W08 H28 BLU

Grooving, Circlip Ring Grooves DIN 471/472

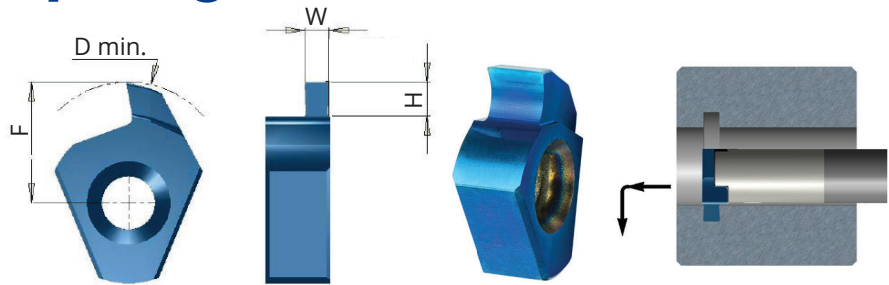

Insert Type	Ordering Code	Nom` groove width	W +0.03	R	H max	D min	F
T8	TD8 G W07 H12	0.7	0.73	0	1.2	8.8	4.3
	TD8 G W08 H13	0.8	0.83	0	1.3	8.9	4.4
	TD8 G W09 H18	0.9	0.93	0	1.8	9.4	4.9
	TD8 G W12 H18	1.1	1.20	0	1.8	9.4	4.9
	TD8 G W14 H18	1.3	1.40	0	1.8	9.4	4.9
	TD8 G W17 H18	1.6	1.70	0	1.8	9.4	4.9
T10	TD10 G W07 H12	0.7	0.73	0	1.2	11.9	6.4
	TD10 G W08 H13	0.8	0.83	0	1.3	12.0	6.5
	TD10 G W09 H15	0.9	0.93	0	1.5	12.2	6.7
	TD10 G W12 H28	1.1	1.20	0	2.8	13.4	7.9
	TD10 G W14 H28	1.3	1.40	0	2.8	13.4	7.9
	TD10 G W17 H28	1.6	1.70	0	2.8	13.4	7.9

Order example: TD10 G W17 H28 BLU

Full Radius Grooving

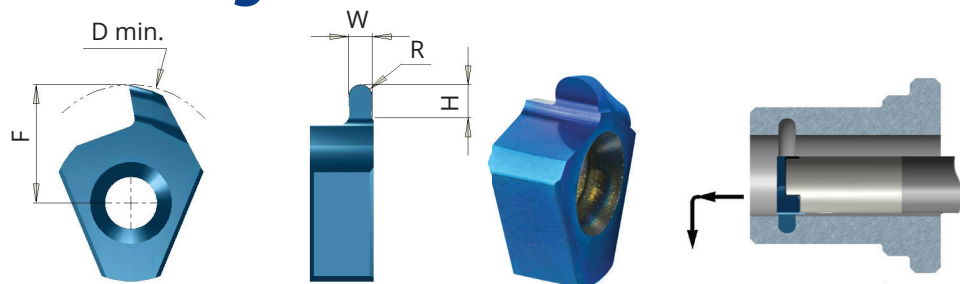

Insert Type	Ordering Code	W ± 0.02	R	H max	D min	F
T8	T8 K R04 H10	0.8	0.4	1.0	8.4	4.1
	T8 K R06 H10	1.2	0.6	1.0	8.4	4.1
	T8 K R09 H10	1.8	0.9	1.0	8.4	4.1
T10	T10 K R04 H22	0.8	0.4	2.2	13.1	7.9
	*T10 K R04 H40	0.8	0.4	4.0	13.5	7.9
	T10 K R06 H22	1.2	0.6	2.2	13.1	7.9
	*T10 K R06 H40	1.2	0.6	4.0	13.5	7.9
	T10 K R09 H22	1.8	0.9	2.2	13.1	7.9
	*T10 K R09 H40	1.8	0.9	4.0	13.5	7.9
	T10 K R10 H22	2.0	1.0	2.2	13.1	7.9
	*T10 K R10 H40	2.0	1.0	4.0	13.5	7.9

*To use with T10 toolholders version B

Back Turning

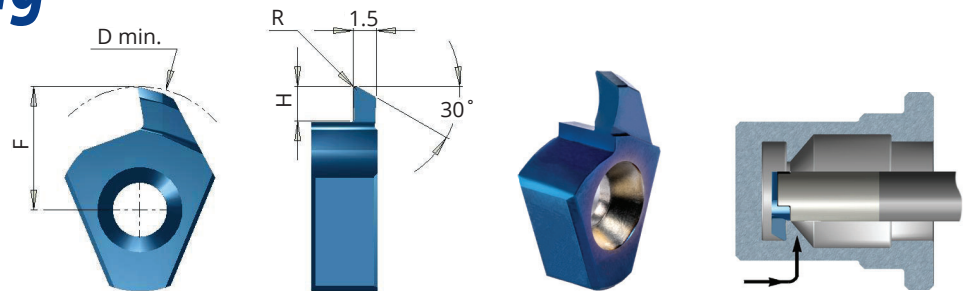

Insert Type	Ordering Code	R	H max	D min	F
T8	T8 X R02 H20	0.2	2.0	9.4	5.1
T10	T10 X R02 H23	0.2	2.3	13.1	7.9
	*T10 X R02 H35	0.2	3.5	13.5	7.9
	T10 X R04 H23	0.4	2.3	13.1	7.9

*To use with T10 toolholders version B

Boring and Profiling

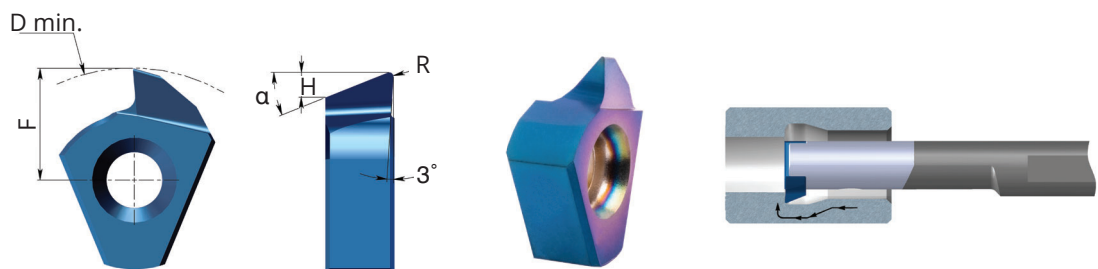

Insert Type	Ordering Code	α	R	H	D min	F
T8	T8 PR R01 A22	22°	0.1	1.0	9.2	5.0
	T8 PR R02 A22	22°	0.2	1.0	9.2	5.0
	T8 QR R01 A47	47°	0.1	1.9	9.2	5.0
	T8 QR R02 A47	47°	0.2	1.9	9.2	5.0

Order example: T8 PR R01 A22 BLU

Boring, Profiling and Facing

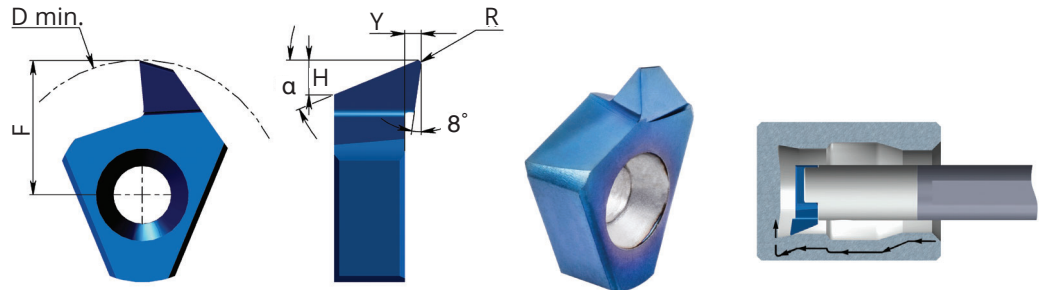

Insert Type	Ordering Code	α	β	R	H	Y	D min	F
T10	T10 PR R01 A22	22°	8°	0.1	1.9	0.9	12.9	7.7
	T10 PR R02 A22	22°	8°	0.2	1.9	0.9	12.9	7.7
	T10 QR R01 A47	47°	3°	0.1	2.6	0.4	12.9	7.7
	T10 QR R02 A47	47°	3°	0.2	2.6	0.4	12.9	7.7

Order example: T10 PR R01 A22 BLU

Face grooving Internal

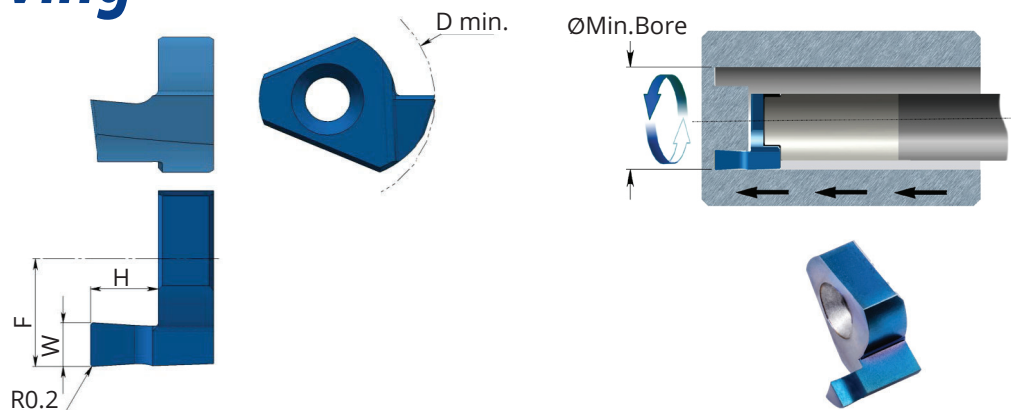

Insert Type	Ordering Code	W ±0.02	H max	D min	F
T10	T10 FI W10 H15	1.0	1.5	14.0	8.0
	T10 FI W15 H25	1.5	2.5		
	T10 FI W20 H30	2.0	3.0		
	T10 FI W20 H50	2.0	5.0		
	T10 FI W25 H30	2.5	3.0		
	T10 FI W25 H50	2.5	5.0		
	T10 FI W30 H30	3.0	3.0		
	T10 FI W30 H50	3.0	5.0		

Order example: T10 FI W30 H50 BLU

External

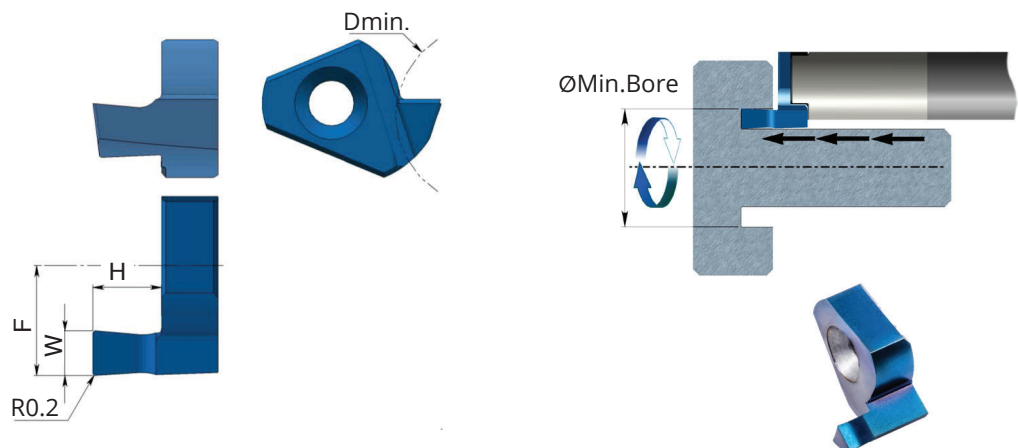

Insert Type	Ordering Code	W ±0.02	H max	D min	F
T10	T10 FE W10 H15	1.0	1.5	12.0	8.0
	T10 FE W15 H25	1.5	2.5		
	T10 FE W20 H30	2.0	3.0		
	T10 FE W20 H50	2.0	5.0		
	T10 FE W25 H30	2.5	3.0		
	T10 FE W25 H50	2.5	5.0		
	T10 FE W30 H30	3.0	3.0		
	T10 FE W30 H50	3.0	5.0		

Face grooving, Full radius Internal

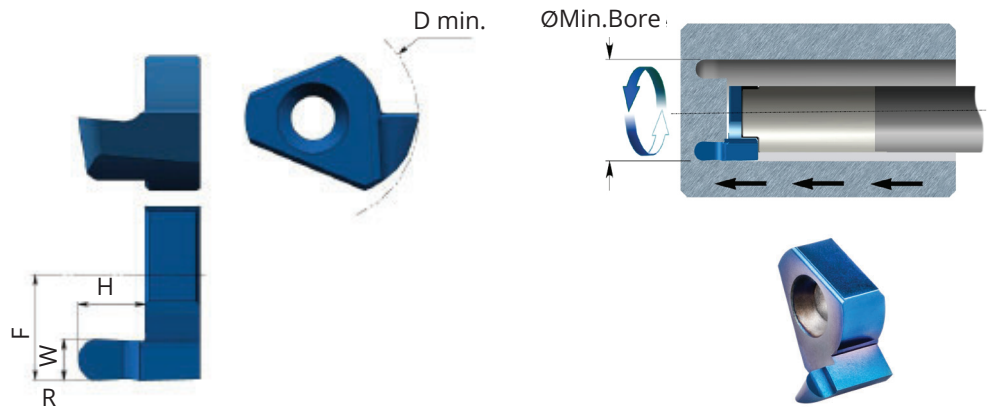

Insert Type	Ordering Code	W ±0.02	R	H max	D min	F
T10	T10 ZI R05 H15	1.0	0.5	1.5	14.0	8.0
	T10 ZI R08 H25	1.6	0.8	2.5		
	T10 ZI R10 H30	2.0	1.0	3.0		
	T10 ZI R125 H30	2.5	1.25	3.0		
	T10 ZI R15 H30	3.0	1.5	3.0		

Order example: T10 ZI R05 H15 BLU

External

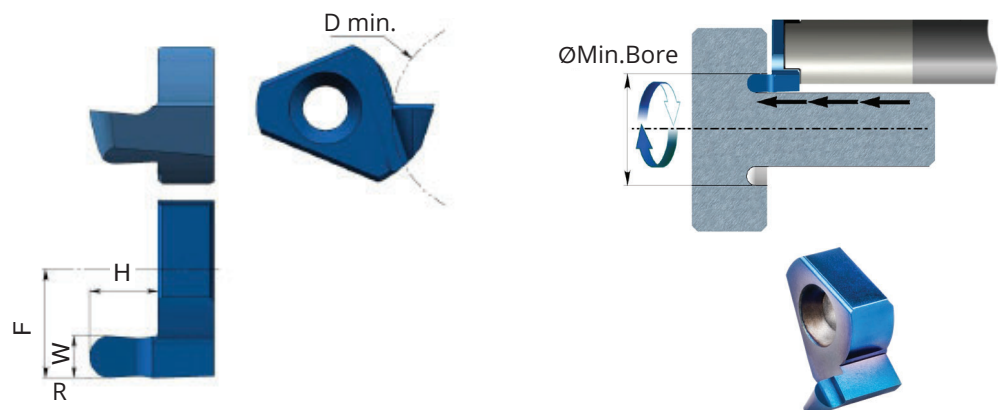

Insert Type	Ordering Code	W ±0.02	R	H max	D min	F
T10	T10 ZE R05 H15	1.0	0.5	1.5	12.0	8.0
	T10 ZE R08 H25	1.6	0.8	2.5		
	T10 ZE R10 H30	2.0	1.0	3.0		
	T10 ZE R125 H30	2.5	1.25	3.0		
	T10 ZE R15 H30	3.0	1.5	3.0		

Carbide Shank Toolholders

With through coolant

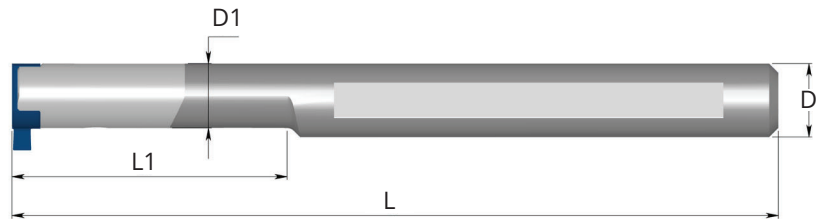

Insert Type	Ordering Code	D	D1	L1	L	Insert Screw	Torx Key
T8	ST 0008 L20 F08C	8	7	20	80	S5	K5
	ST 0008 L30 G08C	8	7	30	95	S5	K5
	ST 0008 L40 H08C	8	7	40	105	S5	K5

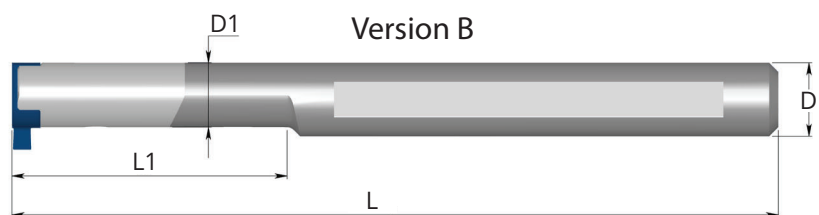
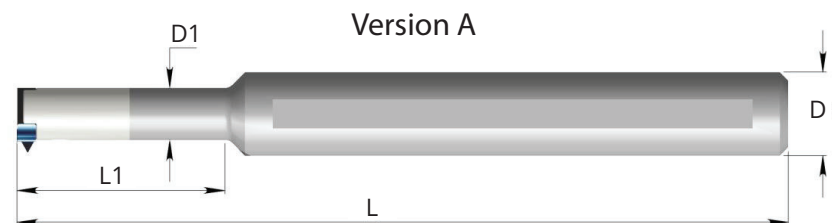

Insert Type	Ordering Code	D	D1	L1	L	Insert Screw	Torx Key	Toolholder Version
T10	ST 0010 L29 H10C	10	8.8	29	100	S11	K11	B
	ST 0010 L40 J10C	10	8.8	40	110	S11	K11	B
	ST 0010 M10C	10	10.0	-	150	S11	K11	A
	ST 0012 L37 J10C	12	8.8	37	110	S11	K11	B
	ST 0012 L40 J10C	12	10.0	40	110	S11	K11	A
	ST 0012 L50 K10C	12	8.8	50	125	S11	K11	B
	ST 0012 L55 K10C	12	10.0	55	125	S11	K11	A

Order example: ST 0012 L37 J10C

Steel Toolholders

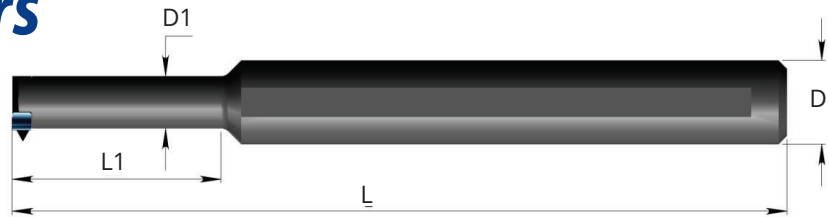

Insert Type	Ordering Code	D	D1	L1	L	Insert Screw	Torx Key
T10	ST 0012 L25 E10	12	10	25	70	S11	K11
	ST 0016 L25 G10	16	10	25	90	S11	K11
	ST 0016 L35 H10	16	10	35	100	S11	K11

Technical Section

Carbide Grades

BLU PVD triple layer coated Sub-Micron grade for Steel, Stainless Steels, Titanium and hard materials.

Cutting Data

ISO	Materials	Cutting Speed m/min	Recommended feed rate mm/rev
P	Low and Medium Carbon Steels <0.55%C	25 - 70	Grooving: 0.01-0.03 Back turning: 0.03-0.10 Face grooving: 0.01-0.08 Chamfering: 0.02-0.08
	High Carbon Steels ≥0.55%C	20 - 50	
	Alloy Steels, Treated Steels	15 - 30	
M	Stainless Steels - Free Cutting	25 - 70	
	Stainless Steels - Austenitic	20 - 40	
	Cast Steels	30 - 70	
K	Cast Iron	15 - 30	
N	Aluminum ≤12%Si, Copper	30 - 90	
	Aluminum >12% Si	20 - 70	
	Synthetics, Duroplastics, Thermoplastics	20 - 70	
S	Nickel Alloys, Titanium Alloys	20 - 50	
H	Hardened Steel 45 - 50HRc	10 - 40	

Threading Passes

Pitch:	mm	0.5	0.7	0.8	1.0	1.25	1.5	2-5
	TPI	48	36	32	24	20	16	14-5
Number of Passes		6-12	7-14	7-16	8-18	8-20	10-22	20-38